

# a comparative ATLAS



RESDAL (*Red de Seguridad y Defensa de América Latina*) was created in 2001 with the mission to promote institution-building across Latin America, by strengthening civilian leadership capabilities.

Its main focus of activity is the production of information on regional security and defence matters, the conduct of research projects, regular assistance to civil society organizations and government agencies, and the promotion of open dialog and exchange of key players of the region.

RESDAL members include academics and practitioners who, through a collaborative work, seek to enhance democracy development in the sector. At the network's website (<http://www.resdal.org> and <http://www.resdal.org.ar>), we offer a user-friendly tool that can be used as a meeting point to obtain information as well as to contact institutions as well as subject-matter experts.

A Comparative Atlas of Defence in Latin America and Caribbean shows the working dynamics and spirit of collaboration which steers the members of RESDAL. It provides comparative and practical information about defence matters in the region, and it is presented both comparatively, as well as on a country-by-country basis, highlighting their legal frameworks, budgets, organizational structures, policy considerations. Published on a bi-annual basis, its first edition was released in 2005, and an electronic edition, updated regularly, can be found at <http://atlas.resdal.org>.



A Comparative Atlas of Defence in Latin America and Caribbean / 2010 Edition

# a comparative ATLAS

of defence in Latin America and Caribbean



2010 Edition



**A Comparative Atlas  
of Defence  
in Latin America  
and Caribbean**

**2010 Edition**



Red de Seguridad y Defensa de América Latina

Donadio, Marcela

A Comparative Atlas of Defence in Latin America and Caribbean / Marcela Donadio y María de la Paz Tibiletti. - 1a ed.

- Buenos Aires : RESDAL, 2010.

312 p. ; 30x21 cm.

ISBN 978-987-25167-4-1

1. Cooperación Internacional. I. Tibiletti, María de la Paz II. Título

CDD 327.1

Cataloguing Date: 29/10/2010

---

■ *Directors*

Marcela Donadio

Paz Tibiletti

---

■ *General Coordinator*

Samanta Kussrow

---

■ *Electronic edition Coordinator*

María Teresa Vera

---

■ *Researchers*

Gonzalo Álvarez Fuentes

Renata Avelar Giannini

Felipe Bernardo Estre

Patricia de Valenzuela

Nadia Kreizer

Patricio Maffei Gaido

Cecilia Mazzotta

Iris Pérez Díaz

Elaine Tardin Borges

---

■ *Assistants*

Jahir Dabroy Araujo

Nadia Fulia Urcelay

Ana Laura García

Paula Ocampos

Gonzalo Serra

---

■ *Academic Advisor*

Juan Rial

---

■ *Special collaboration*

Roberto Cajina

Hal Klepak

---

■ *Translation*

Spell citi

Technical editor: Liliana Medina del Pino

---

■ *Graphic Design*

Rubén Longas

---

◆ RESDAL

Red de Seguridad y Defensa de América Latina

<http://www.resdal.org>

Executive Secretariat

Av Corrientes 1785 – 5° J

(1042) Buenos Aires, Argentina

Tel: (5411) 4371-3822

Fax: (5411) 4371-5522

[secretaria@resdal.org.ar](mailto:secretaria@resdal.org.ar)

<http://atlas.resdal.org>

---

Copyright RESDAL

Deposit made according to copyright law

Printed in Argentina

This publication received sponsoring from:



**National Endowment  
for Democracy**  
*Supporting freedom around the world*



# Table of Contents

<b>Foreword</b> .....	5
<i>Ivelaw Lloyd Griffith</i>	
<b>Preface</b> .....	7
<i>Marcela Donadio</i>	

## THE REGION

### Considering the Region

<b>Latin America and the Caribbean: rethorical progress and no binding agreements</b> .....	12
<i>Francisco Rojas Aravena</i>	
<b>Defence and Cooperation in the Hemisphere: today's puzzling scenario</b> .....	15
<i>Hal Klepak</i>	

<b>CHAPTER 1: The Legal Framework</b> .....	19
Analysis / Military Constitutional Missions in Latin America.....	36
<i>David Pion-Berlin</i>	
<b>CHAPTER 2: The Institutions</b> .....	39
Analysis / The Ministries of Defence and the Political Power.....	48
<i>Juan Rial</i>	
<b>CHAPTER 3: The Budgets</b> .....	51
Analysis / Running the Arms Race? A Contribution to Debate from a Measured Approach.....	56
<i>Gustavo Sibilla</i>	
<b>CHAPTER 4: Political Definitions</b> .....	59
Analysis / The Hidden Appeal of Defence.....	66
<i>Rut Diamint</i>	
<b>CHAPTER 5: Hemispheric Relations</b> .....	69
Analysis / US Southern Command Relations with the Region.....	79
<i>George Withers</i>	
Brazil's Role in the Hemisphere.....	80
<i>Maria Celina D'Araujo</i>	
<b>CHAPTER 6: Education</b> .....	83
Analysis / Professional Military Education.....	88
<i>Thomas C. Bruneau</i>	
<b>CHAPTER 7: The Armed Forces</b> .....	91
Analysis / Military Organization and Force Design.....	99
<i>Jaime García Covarrubias</i>	
<b>CHAPTER 8: Defence and National and International Community</b> .....	101
Analysis / National Defence and Disasters: a Preliminary Approach.....	110
<i>Roberto Cajina</i>	
<b>CHAPTER 9: Special Section: The Caribbean</b> .....	113
Analysis / Defence in the Anglophone Caribbean.....	124
<i>Dion Phillips</i>	

<b>CHAPTER 10: Argentina</b> .....	130
Analysis / Argentina: An Active Player in the Regional Cooperation Process .....	138
<i>Jaime Garreta</i>	
<b>CHAPTER 11: Bolivia</b> .....	140
Analysis / Plurinational State and Armed Forces in Bolivia .....	148
<i>Loreta Tellería Escobar</i>	
<b>CHAPTER 12: Brazil</b> .....	150
Analysis / Defence Policy in Brazil .....	160
<i>Shiguenoli Miyamoto</i>	
<b>CHAPTER 13: Chile</b> .....	162
Analysis / National Defence and the February 27 Earthquake .....	170
<i>Miguel Navarro Meza</i>	
<b>CHAPTER 14: Colombia</b> .....	172
Analysis / From the "Strategic Leap" to "Democratic Prosperity" .....	180
<i>Jesús Alberto Ruiz Mora</i>	
<b>CHAPTER 15: Cuba</b> .....	182
Analysis / The Armed Forces in the Cuban Transition .....	190
<i>Rafael Hernández</i>	
<b>CHAPTER 16: Dominican Republic</b> .....	192
Analysis / The Impact of Constitutional Changes .....	200
<i>Josefina Reynoso Chacón</i>	
<b>CHAPTER 17: Ecuador</b> .....	202
Analysis / Ecuador: Political Redefinitions, Institutional Adjustments and Regional Projection .....	210
<i>Pablo Celi</i>	
<b>CHAPTER 18: El Salvador</b> .....	212
Analysis / El Salvador: Defence and Public Security Policy .....	220
<i>Antonio Martínez-Uribe</i>	
<b>CHAPTER 19: Guatemala</b> .....	222
Analysis / Guatemala's Armed Forces: 15 Years After Peace .....	230
<i>Gabriel Aguilera Peralta</i>	
<b>CHAPTER 20: Honduras</b> .....	232
Analysis / Political System, Armed Forces and Interruption of Constitutional Order .....	240
<i>Leticia Salomón</i>	
<b>CHAPTER 21: Mexico</b> .....	242
Analysis / "War" on Drugs .....	252
<i>Jesús Aranda Terrones</i>	
<b>CHAPTER 22: Nicaragua</b> .....	254
Analysis / From Guerrilla to Institutional Consolidation: the Special Evolution of the Nicaraguan Army .....	262
<i>Carlos Arroyo Borgen</i>	
<b>CHAPTER 23: Paraguay</b> .....	264
Analysis / The Armed Forces' Modernization Process .....	272
<i>Richard Ferreira</i>	
<b>CHAPTER 24: Peru</b> .....	274
Analysis / Peru 2009-2010, The Challenges of Growth .....	282
<i>Ciro Alegría Varona</i>	
<b>CHAPTER 25: Uruguay</b> .....	284
Analysis / <i>The Frente Amplio</i> in Government and the Military Situation	
After five years, the most complex challenges arrive .....	292
<i>Julián González Guyer</i>	
<b>CHAPTER 26: Venezuela</b> .....	294
Analysis / Venezuela's Defence Sector: National and International Landmarks (2008-2010) .....	302
<i>Francine Jacome</i>	
<b>CHAPTER 27: Special Section: Haiti</b> .....	305
Analysis / Reflections on the Haitian Crises .....	310
<i>Héctor Saint-Pierre</i>	



## Foreword

I am delighted to have the opportunity to introduce you to this new feature of the Atlas which includes description and analysis of some of the defence and security realities in the Caribbean region.

The security realities of the Caribbean have several features in common with the realities of the hemispheric as a whole. Moreover, as one would expect, the region has some elements that places it in stark contrast with the rest of the hemisphere.

In terms of commonalities, as in the hemisphere generally, there is in the Caribbean the primacy of non-traditional security threats over conventional ones, which highlights the centrality of internal security issues such as drugs, crime, and violence. This is not to say that conventional matters, notably territorial and border disputes, have lost their salience, either in the Caribbean or in Latin America. For example, the disputes involving Guatemala and Belize, Venezuela and Guyana, and Suriname and Guyana are still among several significant and unresolved controversies.

There is no inter-state conflict any place in the hemisphere, and there is no justifiable concern about nuclear proliferation or an arms race, although the matter of confidence building is still germane. Thus, it is the non-traditional arena, notably drugs, crime, and violence, which is dominating the debate among scholars and journalists and commanding the attention of policy makers and security practitioners. This is true for the entire hemisphere, including the Caribbean.

Beyond this, the Caribbean shares with the rest of the hemisphere a dynamic geopolitical environment. Notable here is China's increasing military and security engagement and economic and commercial investment. Undoubtedly, China is guided by a strategic vision in this pursuit. The China push has led to further tussles with Taiwan over diplomatic recognition in the Caribbean and Central America.



ALBA contributes to this dynamic geopolitical scene. Although only Antigua and Barbuda, Dominica, and St. Vincent and the Grenadines are ALBA members, the geopolitical aspect is enhanced by the participation of those Caribbean nations plus several others in Petrocaribe, a foreign policy instrument for Venezuela which also created ALBA. As well, the geopolitical matrix is being influenced by the re-engagement of Russia, Iran's outreach, and a new engagement discourse by the United States following the election of President Barack Obama.

For all these reasons and others, which space does not permit me to address, the inclusion of the Caribbean security landscape in this Atlas is both welcome and invaluable, as it permits a more complete portrait of the defence and security realities of our hemisphere.

A handwritten signature in blue ink, appearing to read 'Ivelaw Lloyd Griffith', written in a cursive style.

*Ivelaw Lloyd Griffith*

## Preface

The Comparative Atlas has changed its name and is proud to present this new edition that comprises regional data. The following pages you are about to read are the result of a two-year research which led to the elaboration of the *Comparative Atlas of Defence in Latin America and the Caribbean*, including topics, indicators and information presented for the first time in a paper of this nature.

This fourth edition reflects both the permanence and evolution of the hemisphere. At the time of the first edition (2005), a significant effort was placed on transparency of data such as the number of military troops and defence organizational structures. By 2007, the publication sought to establish a link with official institutions that could reinforce the bridge and cooperation ties between the State, the academia and civil society, towards an enhanced democratic development. The third edition revealed the regional progress attained in this respect, and was presented as material for the VIII Defence Ministerial of the Americas held in Canada in 2008. If we take a look at this trajectory, it seems only logical that RESDAL should now identify what new challenges may emerge and what response should be conceived to address regional dynamics.

One first challenge was reflecting the hemispheric consistency, by including the Caribbean region with which a large security space is shared.

The second one was presenting data on Cuba as part of the information on the Latin American Region itself.

The third was reflecting the dynamic nature of defence matters and such issues and events that are gaining more impetus, transcending regions or national characteristics.

The introduction of data from the English-speaking Caribbean countries has been both relevant and timely. With this edition, we are accomplishing an objective whose need was expressed from the beginning by Caribbean countries in 2007 when they requested information on Latin America in English language. The bridges laid down among regions and the interaction across the greater space, i.e. the hemisphere as a whole, are many and address a security scenario





that goes beyond geographic frontiers. Mutual knowledge between Latin America and the Caribbean is still scarce and needs to be reinforced. The intention to encourage this approach through the dissemination of experiences and data was enthusiastically welcomed by the security and defence institutions of the Caribbean countries involved, which wilfully furnished information and generously gave their time to cooperate in shaping what we present herein. The richness of this region is evidenced both in the mechanisms and security organizations as well as in the celebration of the World Cricket Cup, a paramount multilateral practice for regions which (like Central America or South America) also seek to advance in that sense.

These expressions of multilateral agreement and actions are also part of the most outstanding characteristics of how information is presented here. The chapter on hemispheric relations attempts to show the profuse and dynamic network of relations between countries, and the fact of assigning chapter to this area, shows the relevance the matter has gained from the abundance of information that springs every day. From the variety of bilateral agreements to hemispheric initiatives, including sub-regional mechanisms such as the South American, Caribbean and Central American initiatives, there emerges both the richness and complexity of defence in the region.

The edition is also innovative in the chapter devoted to Cuba, which holds relations with all countries but one, and several countries have relations of the so-called “military diplomacy” nature with the Caribbean island. Without regional sources for the matter, the data has been focussed on disseminating concepts and organizations as well as information on the civil defence system considered as a model in several parts of the world; and the relations with the United States, a matter that has also been included --beyond the Cuban case-- as part of the hemispheric relations scenario. In all such cases, as usual, the Comparative Atlas is presented as a work in process, or as a collection of various data that can nurture new developments into the future.

Thus, the matters presented in the various chapters are based on the indicators shown by the political defence practice across the region and, fundamentally, the evolution experienced. All countries operate in a complex regional context where different dynamics are played: agreements coexist with historical claims, and budget increases with diverse interpretations; proposals of own capabilities with practices that seek cooperation; laws amended with ministries facing difficulties to generate and consolidate civilian leadership and others.

Other data presented --such as policy guidelines-- seek to advance on the more classical discussions on conceptual meanings resulting in other data that may seem minor but actually direct the everyday life of institutions. This has been the criterion that has prevailed in the choice of data presented across the entire publication: making visible what may not seem that visible, and leaving the reader the

freedom to evaluate the meaning. Along the same lines, a unique chapter –defence and community—is included to reflect the matters and activities that may seem of a secondary priority but which, in practice, receive high attention in the various countries, including development, internal order, social work of the armed forces. It was not easy to give it a title; finally the one chosen is actually a challenge for the reader, so that a more precise title will come out when more clarity is given to the defence sector projections in this area.

Multiple actors have contributed with their input in each country with great patience upon the requests of information, including ministries of defence and the armed forces who we thank again for their contribution. The enhanced wealth of information enabled to work on different topics. So much so, that we almost naturally resorted to the guide of recognized regional experts to cooperate in the evaluation and to think about how to manage all such information. Roberto Cajina, Hal Klepak and Juan Rial are more than highly prestigious consultants we relied on; they designed tables, evaluated data, edited mistakes, and were mainly responsible for the aim to raise the bar of this publication. They joined with their enthusiasm a magnificent multinational team of young professionals who worked from Buenos Aires and other cities, tirelessly in their everyday work, and with the contribution of a rich perspective of diversity; the work highly profited from these special features. Thanks to all of them, to the members of the network who answered so many questions and gave hints and pointed to mistakes, who form the foundation of all this effort, as well as to the support of the Latin American program of the Open Society Institute, once again, we have come to produce this Atlas. And more than ever now with this new bridge between regions, we need to thank the possibility of having this publication in English thanks to the financial support of the Center for Civil Military Relations from Monterrey and the National Endowment for Democracy, as well as the support of Spell CITI for an impeccable, quick and patient translation.

At the end of all this process of information recollection and presentation, we feel that hints can be found in the information by analysts and decision-makers, in things still not asked and in process of development. Openness is not a question in most of the countries that have furnished data. Questions seem to refer to the current structures, to the challenges facing countries or to defence links with society in terms of more general projects.

These dynamics are political, but also institutional and administrative. If the way is better paved now than five years ago, the reason is that the various actors have been more open to introduce new ideas rather than rejecting them, advancing in the development of a democratic culture. In that specific sense, and considering the diversity of information presented by institutions, there is a clearer idea of the meaning of defence as a public policy. As it may be seen, it is difficult for example to view the civil-military matter in traditional terms



now. The democratization has more complex elements than that. The institution-building is also related, into the future, to the development of roles and who will assume such roles, whether civilian or military.

For RESDAL, to undertake a work such as this Atlas presents challenges, but also the chance to be the direct witnesses of institutional strengths and weaknesses, progress and stagnation present in structures and the mindsets. And, above all, it enables to feel part of an effort in which many have given their contribution reflected in this publication whose main sense and strength is precisely its embedded collaborative work.

*Marcela Donadio*  
*RESDAL Executive Secretary*  
*October 2010*

# THE REGION

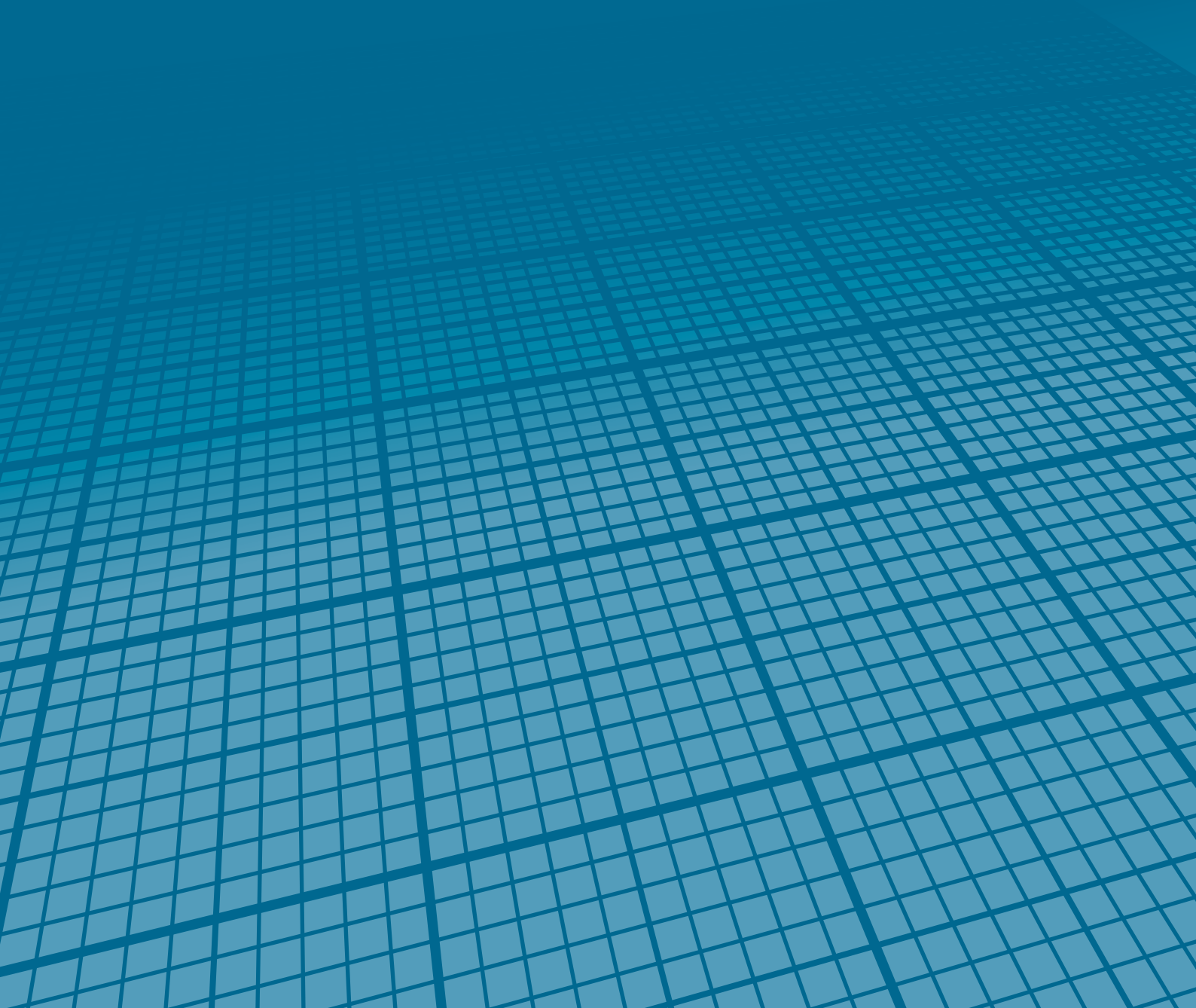



## Considering the Region

# Latin America and the Caribbean

## Rhetorical progress and no binding agreements

**Francisco Rojas Aravena**

*Secretary General of FLACSO*

Latin America continues to be a zone of peace. The region presents a low degree of inter-state conflict, with reduced military threats. However, both in Latin America and the Caribbean, we have a high prevalence of violence, being one of the most violent regions in the world. With only 8% of the world's population, it suffers 40% of murders and 60% of kidnappings. All this use of force poses growing risks and threats to security.

In the new Latin American and Caribbean context, the new political map generates parallel processes of integration and fragmentation. Significant political turbulence has impacted the region over the last few years. Thus, democratic peace and governance has been weakened and even challenged. Since 1990, ten Presidents have not completed their presidential term, and this may be reflected -in most cases- in coups of "a new kind". The risks of repeating the past have increased; the crisis and coup in Honduras are clear evidence of that.

The region does not have clear leadership; there is no one leader in the region to provide the direction to a shared project. Latin America and the Caribbean do not have a strategic political project or a common vision. The models of development are becoming increasingly divergent. There is fierce debate about the models, pathways and instruments required to overcome poverty, inequality and social marginalization. The various visions break down and fragment the political options available. This becomes clear when analyzing aspects such as insertion in the globalization process, models of political, social and cultural development, military projects and defence policies, international alliances, options related to international trade; and particularly types of relationships inside the political system regarding the division of the powers of government, the role

of the justice system, parliaments, communications media, civil society and the Church. The political scenario of Latin America consequently shows high heterogeneity, fragmentation and in some countries, even polarization, thus making it difficult for Latin America to have one single voice.

The search for unity and integration has been a constant effort of the countries across the region from their very inception some 200 years ago. However, there has been more frustration than success. Without a plural and shared vision built around dialogue and consensus building, it will not be possible to have a strategic political perspective capable of classifying the various dimensions and guiding the integrating process embedded in State policies. The last effort in this way was the Summit of Unity held in Cancún in February 2010. There, three elements were strongly revealed: the integration-focused rhetoric, growing mistrust and the lack of political will to advance further. It is even difficult to build a shared agenda in the region due to its heterogeneous nature and this lack of political will.

All those factors are framed within a new international context of greater interdependency and autonomy of the region. Brazil, as an emerging power, has proven that it can be an active player in the global scenario. South-South cooperation is on the rise. The traditional hegemony is challenged. From the region come demands for relations based on respect for the right to association.

### **Defence and security: parallel or converging roads?**

Three countries of the hemisphere are currently at war: Colombia, Mexico and the United States. In the first two cases, it is an internal war against organized

crime, increasingly involving Central American countries, especially Guatemala and Honduras. The United States supports these war efforts through specific programmes: Plan Colombia and the Mérida Initiative. Its attention on the region however is relatively low. The US wars are fought in Afghanistan and Iraq. Latin America and the Caribbean are going through unprecedented levels of violence, even worse than those of the Central American revolutionary wars in the 80s.

The 1970s and 1980s were times of dictatorships across the region. Later came a promising democratic transition in which people in the region recovered from a period in which the State represented one of the main threats to their people, applying the so-called national security doctrine. In the 1990s, Latin America and the Caribbean made significant progress in reducing inter-state conflicts and, especially, in demilitarising them. After the beginning of the 21<sup>st</sup> century, interest in, and focus on the processes aimed at deactivating conflicts fell off, and many endeavours that were under way were not adequately followed up, particularly in the sphere of confidence and security building measures (CSBM).

Today, many nations in the region lack proper State presence in some geographical areas or in their main cities, thus creating new vulnerabilities and threats to the population. In this scenario, transnational non-state actors are threatening the stability and security of each one of our countries.

We face different types of threats and we must address different kinds of violence. On one hand, we are confronted with sovereignty and border issues which are linked to defence policies and military power. On the other, there is violence caused by organized crime, juvenile gangs and the use of small arms. We can also mention a re-emergence of conflicts over resources and the environment.

In the defence and sovereignty spheres, the dispute among Ecuador, Colombia and Venezuela, especially between the two latter countries, has been prolonged in time and escalated considerably in the last two years. Frictions are constant. The statements made by the leadership of these countries show high mistrust, making it even more difficult to find diplomatic ways to settle the conflict. The threat of the use of force is latent and it is necessary to eradicate it. Also in the defence arena, tensions derived from border issues

in Central America, the Caribbean and South America could result in tensions and risks if not handled adequately.

In the case of Colombia, its special relationship with the United States (in relation to Plan Colombia, but particularly the facilities provided to the US in seven military bases), has raised concern and a negative reaction in South America, aside from the ongoing political and ideological differences manifested by various countries. It is a serious concern because of the presence of foreign militaries on South American soil. In meetings with Latin American Heads of State, the US Secretary of State Hillary Clinton personally undertook to provide the necessary information which could help dissipate their concerns. However, recurring tensions in “the Great Colombia” hinder the possibility of dialogue to deal with these issues.

Hence, in the absence confidence-building measures and given a reluctance to enter into binding agreements, Latin American countries have significantly increased their military spending. During the period of economic prosperity in Latin America (2003-2008), military spending rose almost 100% and the suppliers are UN Security Council permanent members. Sub-regional arrangements aimed at reaching effective agreements in the area are so far still only an aspiration, as shown by the Declaration of Lima (OAS).

In the security sphere, violence increasingly causes more casualties, refugees and displaced persons every day, thus raising the economic cost of security in every society. Mexico’s annual casualties are over 25,000 people and Colombia’s displaced persons amount to over 2.5 million. Murders in Latin America have leaped, creating fear and turning the region into the most violent in the world. National murder rates per 100 thousand inhabitants are: Guatemala 48, El Salvador 52, and Honduras 58. Transnational crime impacts every Latin American country. Its networks are globally connected and make an efficient use of cutting-edge technologies, in many cases exceeding the operational capacity and fire power of government law-enforcement. This situation shows deep problems of inter-state coordination and cooperation as well as the international connections of organized crime.

In a context of fragile Latin American democracies, organized crime is the main security threat to the rule of law and order. The answer to this, from Mexico to Colombia, including Central America and even in Rio



and Sao Paulo (Brazil), has been militarization, which leads to the privatization of security and warfighting and taking away the monopoly of force from the State. Such a policy approach has not rendered the expected results. The clearest example is Plan Colombia and the struggle against drug trafficking, although it has made progress in controlling the guerrillas. To fight against organized crime, an agreed subregional, regional, hemispheric and global effort is required.

The environmental disputes between Ecuador and Colombia, and between Argentina and Uruguay, have found a settlement vehicle in the International Court of Justice. However, new conflicts linked to resources and the environment might possibly arise, and no adequate institutional forum is in place to manage them.

However, to address such conflicts, all with chances of escalating, there is no shared doctrine. Nor is there a common doctrine on the roles for the military and law-enforcement. Aside from political and ideological differences, approaches on defence and security are varied, thus making it difficult to build a common strategy. All actors involved claim the need for a transnational and global approach; however, no substantive agreements on key principles in order to further a common vision have been reached. In this area, the United States is the main player, whereas the European Union has little weight and other Asian countries are virtually absent.

Poverty, inequity and inequality are a significant element of the risks and threats to security. In this matter, countries have not discovered how to confront and resolve the situation, nor do they have sustainable and agreed plans for the short term.

### **Progress outside formal institutions.**

#### **How to establish cooperation?**

If we consider institution-building efforts, we must underscore that there is no effective formal mechanism for conflict prevention and resolution in Latin American and the Caribbean. However, if we take a look at specific situations such as the UNASUR effort, in Central America and the Caribbean, prospects should be brighter. UNASUR and its Defence Council, however, have not been ratified yet. UNASUR is a political project of cooperation and integration in a wider sense, covering from economic and commercial aspects to defence and security. It is a proposal for unity in diversity, integration with pluralism, and

regional cohesion with national sovereignty. Bicentennial anniversaries of countries' independence are a significant incentive in these convergence processes. UNASUR's South American Defence Council has set very ambitious goals. However, the progress and consensus achieved have not translated into binding agreements. Aside from the principles of a step-by-step approach and flexibility in institutional development, the ambitious proposals in CSBM's or signing a Treaty of Peace, Security and Cooperation have yet not resulted in practical measures to deescalate conflicts in the region in relation to defence. Matters related to security must be addressed in the South American Anti-Drug Council (*Consejo Suramericano de Lucha contra las Drogas*), but the progress made in this Council is minimum. A clear distinction is made with respect to military and law-enforcement roles, though this is not reflected in practice by the actions of member countries where militarization blurs roles.

If no progress is made in a political atmosphere of trust among Latin American and Caribbean heads of state and leaders, there will be no progress in transparency and confidence-building. The proposals and consensus reached in this matter show high density prevailing in paper rather than in binding and verifiable agreements.

Mechanisms established to reduce tensions between neighbours, including agreements between Colombia and Venezuela, have ceased to be effective and are not used. In other cases, meetings have been consistently postponed. If institutional mechanisms are not used for the purposes they have been created for, mistrust increases.

It is essential to work towards consolidating, legalizing and legitimizing the institutions in place, through the ratification of treaties signed. It is also necessary to generate an effective, candid and transparent dialogue to address complex situations, while helping match rhetoric with substantive agreements reached. An essential aspect in this process is to establish control mechanisms.

The 9th Defence Ministerial of the Americas, to be held in Bolivia, could be an excellent opportunity and an appropriate forum to consolidate the objectives of these Ministerial Summits. The meeting in Santa Cruz may create spaces to develop shared concepts in each of the subregions, report them back to the whole region, and build confidence and dialogue towards the attainment of peace and security.

## Considering the Region

# Defence and Cooperation in the Hemisphere: today's puzzling scenario

**Hal Klepak**

*Professor Emeritus of the Royal Military College of Canada*

■ The strident nature of so much of today's inter-American and inter-Latin American relations should make us pause about the dangers when rhetoric and more than mere rhetoric, crosses into the defence and military realms and threatens shared hopes for cooperation, integration and development. Armed forces and defence policies are the summum of considerations of sovereignty and fears about one's neighbours and sometimes other states as well. Indeed, the existence of such policies and forces and their importance are normally a result of considerations of threat coming from others. It is hardly surprising then that those responsible for countering those threats, as well as those, like the military, using 'worst case planning' to prepare to do so, are often reluctant to think in terms of cooperation with those same possible sources of threat.

When the history of those relations is brought into

the discussion, the likelihood of defence considerations being a favourable 'push' factor for cooperation and unity is usually hardly great. One might almost say that defence policies and armed forces are traditionally about *not* putting down your guard and undertaking experiments with integration and cooperation that might threaten one's independence and rarely about doing any such thing.

In reality, however, the situation in the Americas in recent decades has not reflected this traditional state of affairs, a point about which the region should surely feel proud.

In our hemisphere, defence has many times been an element of cooperation-building among the countries of the region, rather than an obstacle. Far different from the historical experience of Europe or Asia, where defence has traditionally been the last link in the cooperation and integration building chain (or





close to it), in the Americas this sector of national and international activity has often been used creatively at an early stage, solidifying efforts to achieve more profound economic and political cooperation.

In North America, for example, we can mention the extraordinary transformation in the context of Canada and the United States which, after centuries of confrontation, changed in less than forty years to become one of the most impressive examples of defence cooperation round the world to date. The role of bilateral cooperation during World War II, when Ottawa saw that it was possible to cooperate with Washington on the world sphere without being squeezed like a dwarf by the giant, was essential to lessen the historical Canadian perception of the United States as a threat. Later in time, the role of NORAD and NATO in confidence-building was key to the evolution of an attitude of mutual respect, which in about one generation or so, changed three centuries of Canadian preparation to defend itself from invasions of the south. Likewise, the United States came to understand that Canada was not merely a Trojan horse for the United Kingdom, but on the contrary sought a friendly relationship with its giant neighbour. Without those changes of perspective, it would have been simply unthinkable to attain political cooperation and ultimately a free-trade agreement. It was defence that opened the door to this change in perception.

Also in Latin America, there are many cases, not so far back in history, where something similar took place. In a dramatic manner, the nuclear programmes of Brazil and Argentina played a significant role as a vehicle for cooperation on key matters between these countries. These ceased to be subject to disagreement and suspicion between Brasilia and Buenos Aires and became a clear demonstration of good will and a shared desire to seek fundamental changes to the historical rivalry between both countries and, eventually, replace such rivalry with a close and friendly relationship.

The connections among Central American countries, again the focus of distrust over most of the period since the late 1830s, likewise changed with the end of the civil wars over the period 1992-1996. Following on the 1996 signing of the *Tratado Marco de Seguridad Democrática*, by all the Central American States, the relationship among regional militaries changed abruptly. Confidence-building measures of

unprecedented scope were put in place as were a vast range of other cooperative arrangements. This also played no small part in the re-establishment of a wider climate of cooperation and integration resulting in the rebirth of the Central American Common Market and many other wider initiatives.

The historic role of Mexico as Central America's 'gigante del norte' has likewise been affected by military efforts in recent decades where Mexico's armed forces have moved quickly to assist Central American countries in dealing with natural disasters. The improvement to Mexico's prestige and the level of regional trust in it has grown and permitted efforts such as Plan Mérida to get a better reception in the region.

Even between Cuba and the United States there has existed a level of defence cooperation on key matters such as controlling illegal migration and support for the US base at Guantánamo that gave the lie to the idea that mutual trust and cooperation between the two countries was somehow impossible. Instead by the 1990s there was considerable military and other security cooperation between the two involving safety and approaches to Guantánamo, handling of overflights of aircraft en route to disaster stricken areas, and the more public joint measures against illegal immigration that troubled both countries. And while no one would surely argue that this was going to lead to political integration or economic cooperation, it did lead to reduced tension and at least the opening of communications between the two.

In Mercosur too, military cooperation has been a growing and significant part of the moves towards wider integration and political cooperation in the regional and some bilateral contexts. Argentine-Brazilian joint military cooperation is now well advanced and like Argentina and Chile a total *volte face* if compared with historical precedent. Chile and Argentina even have in hand the preparation of a joint if small force, termed Cruz del Sur, in stark contrast to their past experience. And while relations between La Paz and Santiago remain deadlocked at the most formal level, cooperation between Bolivia and Chile in the defence area is surprising and reminds both sides that there is much to be gained by working in important fields outside the purely diplomatic to establish confidence. All of this naturally reinforces wider moves for economic and political cooperation.

At the hemispheric level also, the meetings every

two years of the Conference of Defence Ministers of the Americas have become a powerful confidence building measure since the process was started at Williamsburg in 1995, and the gatherings of commanders of armies, navies and air forces, since the 1960s, continue to be friendly gatherings where co-operation is furthered. There is little doubt that the level of confidence these meetings help generate has some spill-over effect into other fields or at least supports other efforts by reducing potential tensions and historic rivalries in the central area of defence.

### *The Present*

The difficulty is that all this past of favourable elements coming from defence for the wider goal of regional or even hemispheric economic and political cooperation, is currently availing less than it might. The continued progress of these efforts is now found against a backdrop of what some analysts consider the worst phase of inter-American diplomatic relations since Independence. Even during the cold war, with the widespread rupture of relations with Cuba, nothing like the present moment has been seen, with at the time of writing Bolivia and Chile, Ecuador and Colombia, Cuba and the United States, and Venezuela and Colombia all having no formal diplomatic relations with one another, and between the US and Bolivia, relations remaining but not at ambassadorial level. Ideological considerations have been added to traditional frontier and jurisdictional issues to produce a grim scene of poor or no relations, heightened name-calling among leaders, and an alarming poisoning of the regional political atmosphere.

The picture could hardly be much more confusing and seemingly contradictory. For in the midst of this negativism, sub-regional advances in cooperation have become not the exception but the rule. While less and less centrality is given to hemispheric security matters, other initiatives have been nothing less than remarkable given the overall state of inter-American and even inter-Latin American relations. UNASUR, the union of South American countries formerly only dreamed of, is now showing real signs of dynamism in the construction of a regional defence agenda. And its South American Defence Council also appears to be an increasingly serious joint initiative with work on founding a regional strategic studies centre, the building of an impressive range of confi-

dence building measures, and other initiatives already in hand. While troubling to many in its exclusion of other nations of the Americas, there is no doubt that as a regional initiative it is impressive and holds out real promise for a South American defence and security forum with clout and importance.

Likewise the Regional Security System in the Eastern Caribbean has shown its utility not only in the anti-narcotics area but also in support for the complicated but successful World Cup of Cricket in 2007. And in the wider Caribbean, joint initiatives such as a single pilot training scheme and school for the whole of the Commonwealth Caribbean is working well and allowing the security forces of those countries to address many issues with until now elusive economies of scale in the defence area.

Indeed, arguably it is in the Caribbean region that the Americas and Latin America in particular have their greatest joint success. For in Haiti, Chile provided a rapid reaction force of exceptional efficacy in the events leading to the deployment of MINUSTAH, the United Nations current mission on the island, Brazil has provided its largest contingent as well as its vital command element, and Latin Americans make up the majority of its force. Many see or at least hope to see this as the first experience of Latin American at least partial 'jointness' that may pave the way to more in the future.

CFAC, the recent Central American military cooperative organisation, is an undoubted success, and crowns the efforts of the post-civil war years and the confidence building that marked them. Not only does the organisation jointly prepare for peacekeeping and natural disasters taskings but also builds confidence. And to the north, Mexico's slow but sure *acercamiento* to North American defence cooperation is a fact greatly appreciated by its US and Canadian neighbours. Since the 1994 Zapatista risings in Chiapas, and now reinforced by the strains on Mexico's internal security of recent months, the relationship with the United States has known the beginnings of what appears to be a sea change with traditional Mexican attitudes so quickly evolving that the country was able and willing to help out the United States, in dramatic fashion, during Hurricane Katrina in 2005.

Again in contrast, the issues causing current rancour in the region in the defence area are many. Some have been caused by US actions such as the reactivation of



the long-disbanded IV Fleet, a naval formation whose deployment had only been contemplated previously for the purposes of World War II and the early cold war (1942-1950), and which therefore would almost certainly raise eyebrows in much of Latin America at a time of rising tensions and distrust of US intentions among many regional governments. The formalizing and expansion of seven base arrangements in Colombia, supposedly merely supportive of the anti-narcotics effort but referred to in US official documents as a means to permit that country to operate more effectively on the military scene in the region as a whole, could hardly fail to annoy some countries. Cuba's obviously absurd placement on the US list of states supporting terrorism, despite its excellent record against that scourge, is another sore point for many.

These are combined with the odd role of the United States in connection with events before and after the coup in Honduras. This event, smacking of traditional coups in the region in its union of oligarchy, church, embassy, and military interests in ousting the constitutional if increasingly illegitimate Zelaya government, sent shock waves through the region especially in reformist governments whose links with their armed forces are often uncertain. Those formerly optimistic that coups were a thing of the past, already shaken by that of Venezuela in 2002, now more rarely hold this view and the ideological and other divisions that wrack the hemisphere have been evident indeed in the aftermath.

The arrival in greater force of extra-regional powers has also had an impact. China especially, but to a lesser degree India and Iran, are now present but at least in the defence field, this presence has been limited. China is the source of concern in some US

circles as to its intentions in the region but Beijing has been careful to allay such fears by a measured military policy which eschews actions which would raise Washington's ire. It is more difficult to say where Teheran and New Delhi's interest may lead, especially in the nuclear field but the US doubtless watches such activities carefully, leading to yet another source of potential discord.

Latin American and hemispheric defence affairs are thus in a confusing context of seeming progress combined with an overall situation of widespread discord and negativism. The ideological divisions faced by the hemisphere and its regions are serious indeed and the poisoning of the atmosphere for wider cooperative efforts is real even if often papered over by sub-regional successes. When those rifts spill into the military and defence field, they gain an importance they do not necessarily have if left in economic and even political spheres. Bombing across borders, basing extra-regional forces without adequate and convincing explanations, wars of words with little moderation of language, military deployments to frontiers each time things look bad: all these point to deep divisions which are dangerous indeed when brought into the military sphere. It will be important, as OAS Secretary-General Insulza has said, to have more opportunities for dialogue, not fewer, if such discord is to be kept within bounds. The disposition for such a dialogue is not always visible nor is its urgency seemingly always understood. It will be a challenge to see that this situation does not endure and that this dangerous context, not only for cooperation and integration but potentially even for peace, is kept under control.

Chapter 1:

# The Legal Framework

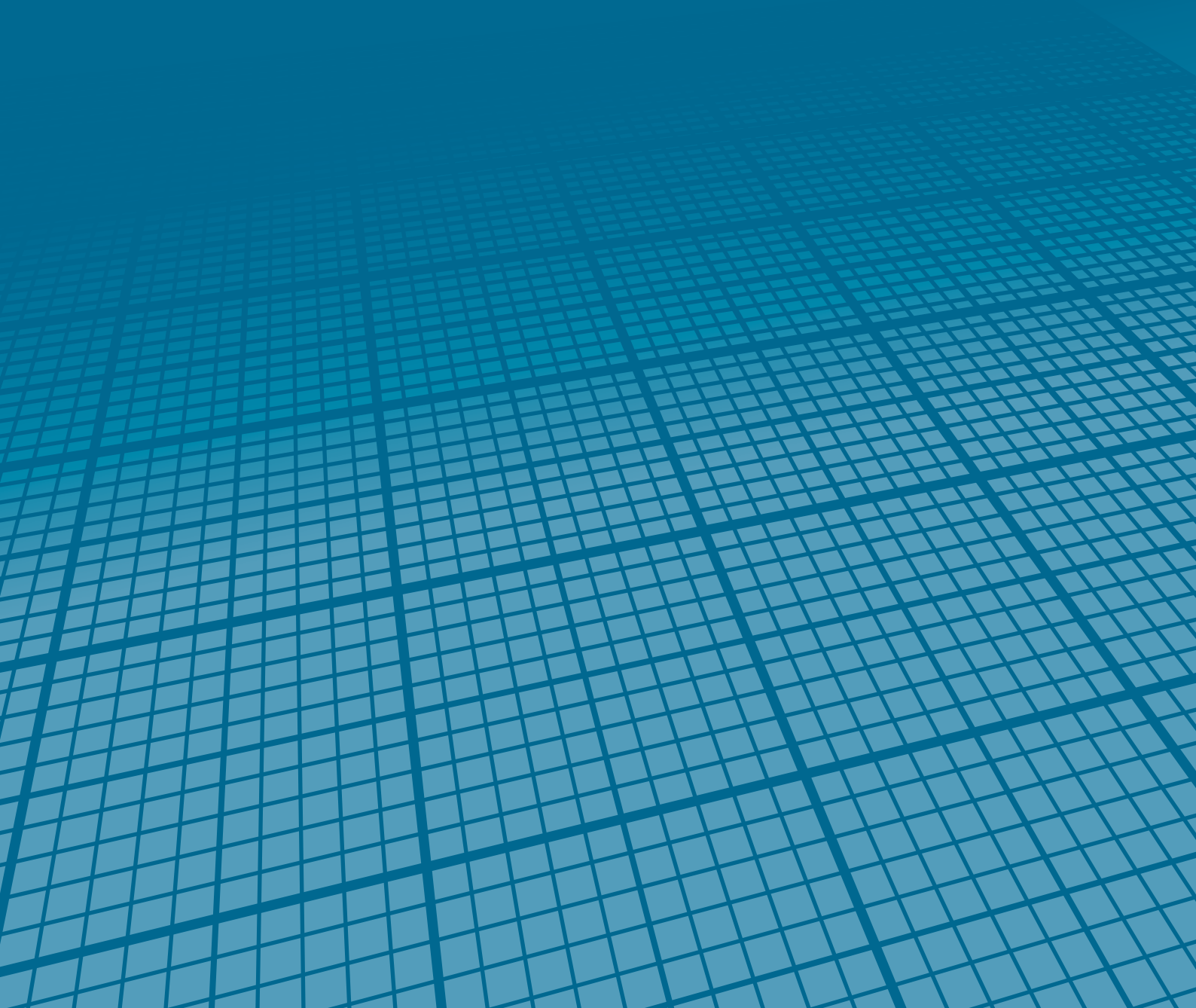



## What do Constitutions define?

Argentina (1853. Last reform 1994)		
Leading Political Procedures	Military Instrument	Other Provisions
<p><b>Powers of the President:</b>                      Commander-in-Chief of the Armed Forces (Sec.99, sub. 12).                      Declare war with the approval of Congress (Sec. 99, sub. 15) and the state of siege in case of external attacks, for a limited period of time, with the approval of the Senate (Sec. 99, sub. 16).                      Appoint senior officers with the approval of the Senate (Sec. 99, sub. 13).                      Arrange, organize and deploy the Armed Forces (Sec. 99, sub. 14).</p> <p><b>Powers of Congress:</b>                      Approve the declaration of war (Sec. 75, sub. 25) and the declaration of state of siege in case of external attacks (Sec. 61).                      Authorize the president to make peace (Sec. 75, sub. 25).                      Authorize the entry of foreign troops to the national territory and allow the deployment of national troops outside the country (Sec. 75, sub. 28).                      Establish the Armed Forces (Sec. 75, sub. 27).                      The Chamber of Deputies has the lawmaking initiative on raising revenues and the recruitment of troops (Sec. 52).                      Organize and govern the Armed Forces (Sec. 75, sub. 27).                      Levy direct taxes for a certain amount of time, in all the territory of the Nation, as long as the defence, common security and State general welfare policies so require (Sec. 75, sub. 2).                      Approve or dismiss treaties entered into with other nations and with international organizations, as well as the concordats with the Holy See (Sec. 75, sub. 22).</p>	<p>No reference.</p>	<p>The Federal Government acts within the territory of the provinces to repel foreign invasions (Sec. 6).                      Citizen participation: every Argentine citizen is bound to bear arms in defence of the Nation and its Constitution (Sec. 21).                      Every citizen has the right of resistance from those who perform acts of force against the institutional order and democratic system. (Sec. 36).                      The Argentine Nation ratifies its legitimate and imprescriptible sovereignty over the Malvinas Islands, Southern Georgias and Southern Sandwich and the corresponding maritime and insular areas, as an integral part of national territory. The recovery of these territories and the full exercise of sovereignty over them, respecting the way of life of their inhabitants, in accordance with the principles of International Law, constitute a permanent and unwavering claim of the Argentine people (First Temporary Provision).                      International treaties and concordats entered into with the Holy See have a higher hierarchy than national laws (Sec. 75, sub. 22 y 24).</p>
Bolivia (2008)		
Leading Political Procedures	Military Instrument	Other Provisions
<p><b>Powers of the President:</b>                      Provide the security and defence of the Nation (Sec. 172, sub. 16).                      Appoint and dismiss the Commander-in-Chief of the Armed Forces and the Chiefs of the Army, the Air Force and Navy. (Sec. 172, sub. 17).                      Recommend to the Plurinational Legislative Assembly the promotions to Army General, Air Force General, Major General and Brigadier General; Admiral, Vice-Admiral and Rear-Admiral (Sec. 172, sub. 19).                      Exercise the powers as Capitán General (Commander) of the Armed Forces and make use of them for the defence of the State, its independence and territorial integrity (Sec. 172, sub. 25).                      The Executive shall have direct access to information on budgeted and executed expenses of the Armed Forces through the appropriate Ministry (Sec. 321, sub. 5).</p> <p><b>Powers of the Plurinational Legislative Assembly<sup>1</sup>:</b>                      Approve the entry of foreign troops to the national territory and the deployment of national troops outside the country (Sec. 158, sub. 1, 21 and 22).                      Approve in each legislature the military strength to be maintained in times of peace (Sec. 159, sub.10).                      Ratify promotions proposed by the Executive to Army General, Air Force General, Major General and Brigadier General; Admiral, Vice-Admiral, Rear-Admiral and Bolivian Police General (Sec. 160, sub. 8).</p> <p><b>Supreme Defence Council of the Plurinational State<sup>2</sup>:</b>                      Makeup, organization and powers established by law, presided over by the Capitán General of the Armed Forces (Sec. 248).</p>	<p><b>The Armed Forces:</b>                      They are composed of the Command-in-Chief, the Bolivian Army, Air Force and Navy (Sec. 243).                      Mission: defend and maintain national independence, security and stability of the State and the national honour and sovereignty; secure the rule of the Political Constitution, guarantee the stability of the legally-established Government and participate in the overall development of the country (Sec.244).                      Organization: Relying on hierarchy and discipline principles. The Armed Forces are to be obedient, non deliberating, and subject to the laws and military regulations. As an institutional body, the Armed Forces shall not carry out any political action; individually, the members of the Armed Forces are entitled to exercise their citizen rights under the terms established by Law (Sec. 245). Active members of the Armed Forces shall not be eligible for public office at elections, unless they have previously resigned at least three months before the election day (Sec. 238, sub. 4).                      The Armed Forces report to the President of the Nation and follow his/her orders on administrative matters, through the Minister of Defence and, on technical matters, through the Commander-in-chief of the Armed Forces (Sec. 246, sub. 1).                      In case of war, operations shall be headed by the Commander-in-chief of the Armed Forces. (Sec. 246, sub. 2).                      No foreign citizen shall be appointed to any command or administrative position in the Armed Forces without prior authorization by the Capitán General of the Armed Forces (Sec. 247, sub. 1).                      Promotions in the Armed Forces shall be determined by law (Sec. 250).                      In case of international war, the Bolivian Police Force shall report to the Command-in-chief of the Armed Forces for the duration of the conflict (Sec. 254).                      The Armed Forces' fundamental duty is to secure the defence, security and control of the border security areas. The Armed Forces shall participate in overall sustainable development policies for these areas and shall ensure their permanent physical presence there (Sec. 263).</p>	<p>Bolivia is a peaceful State that promotes a culture of peace and the right to peace (Sec. 10, sub. 1). It rejects all forms of aggression used to settle disputes and conflicts among States and reserves its right to legitimate defence in case of any aggression that may threaten the State's independence and integrity (Sec. 10, sub. 2).                      It is prohibited to establish foreign military bases in Bolivian territory (Sec. 10, sub. 3).                      Defence is the responsibility of the State (Sec. 12, sub. 2).                      It is the duty of Bolivian citizens to defend, promote and contribute to the right to peace and to promote a peaceful culture (Sec. 108, sub. 4), and it is the duty of Bolivian men to comply with the mandatory military service (Sec. 108, sub. 12).                      Compliance with military duties shall be a requisite to hold public office (Sec. 234, sub. 3).                      The negotiation, signing and ratification of international treaties shall be governed by the principles of independence and equality among States, non-intervention in internal affairs and peaceful resolution of disputes (Sec. 255, sub. II, 1).                      The Bolivian State declares its indisputable and imprescriptible right over the territory giving access to the Pacific Ocean and its maritime space. An effective settlement of the maritime dispute through peaceful means and full exercise of sovereignty over that territory are permanent and unrenounceable claims of the Bolivian State (Sec. 267, sub. 1 and 2).                      It is prohibited to manufacture and use chemical, biological and nuclear weapons, as well as to enter, transport and store nuclear and toxic waste in Bolivian territory (Sec. 344, sub. 1).</p>

1 Asamblea Legislativa Plurinacional. 2 Consejo Supremo de Defensa del Estado Plurinacional.

Brazil (1988. Last reform 2010)		
Leading Political Procedures	Military Instrument	Other Provisions
<p><b>Powers of the President:</b> Initiate laws, on its own, to establish or modify the number of regular military members, rule over members of the military, their justice system, promotions, stability, assignment of positions, remuneration, reform, and transfer to the reserve (Sec. 61, sub. 1). Order the state of defence and state of siege (Sec. 84, sub. 9). Supreme Commander of the Armed Forces (Sec. 84, sub. 13). Appoint the Chiefs of the Armed Forces, and promote general officers (Sec. 84, sub. 13). Convene and preside over meetings of the Council of the Republic and the National Defence Council (Sec. 84, sub. 18). Declare war with the approval of the Congress, in the event of a foreign aggression (Sec. 84, sub. 19). Make peace, with the approval of the Congress (Sec. 84, sub. 20). Allow the entry of foreign troops (Sec. 84, sub. 22).</p> <p><b>Powers of the Congress:</b> Determine and modify the strength of the Armed Forces (Sec. 48, sub. 3). Authorize the President to declare war, make peace and approve the deployment of troops (Sec. 49, sub. 2).</p> <p><b>Council of the Republic<sup>3</sup>:</b> It is the President's higher consultation body (Sec. 90). Expresses position on federal intervention, state of war and state of siege (Sec. 90, sub. 1).</p> <p><b>National Defence Council<sup>4</sup>:</b> It is the President's consultation body on issues related to national sovereignty and the defence of the democratic State (Sec. 91). Expresses its position on war declaration and peace settlement (Sec. 91, sub. 1); declaration of the state of defence, state of siege and federal intervention (Sec. 91, sub. 2). Proposes the criteria and conditions for the use of areas which are key to the security of the national territory, and expresses opinion on its effective use, especially on border zones and those associated with the preservation and exploitation of natural resources of any kind (Sec. 91, sub. 3).</p>	<p><b>The Armed Forces:</b> The Armed Forces are a national permanent, regular and non-political institution, organized on the bases of hierarchy and discipline. They are composed of the Navy, the Army and the Air Force (Sec. 142). Mission: defend the Motherland and guarantee constitutional powers as well as, on the latter initiative, law and order (Sec. 142). Service member incorporation, age limits, rights, obligations, remuneration, prerogatives and other special situations of military members, given the nature of their activities, including duties under international commitments and war shall all be determined by law (Sec. 142). The members of the military on active duty are not entitled to join labour unions or go on strike; neither can they join a political party (Sec. 142, sub. 4); they shall not be candidates at elections (Sec. 14, sub. 8), habeas corpus does not apply to military disciplinary punishment (Sec. 142, sub. 2). Military service is compulsory in accordance with the law (Sec. 143). Military justice: it shall be incumbent upon the Military Courts to try and judge military crimes defined by law. Military justice organization, operation and competence shall be determined by law (Sec. 124).</p>	<p>Brazil's international relations are governed, among other principles, by the defence of peace and peaceful resolution of disputes (Sec. 4, sub. 6 and 7). The action of armed groups, either civil or military, against the constitutional order and the democratic State is a crime not subject to limitation (Sec. 5, sub. 44). The Union must ensure national defence and celebrate peace, as well as allow foreign forces to transit or remain temporarily in national territory, under the circumstances specified by supplementary laws. Declare the state of siege, the state of defence and federal intervention. Authorize and oversee the production and sale of warfare material (Sec. 21). All nuclear activity within the national territory shall only be admitted for peaceful purposes and subject to approval by the National Congress (Sec. 21, sub. 23, a). The Union is responsible for legislating on civil and military requisition, in case of imminent danger and during war times (Sec. 22, sub. 3), general regulations, organization, troops, warfare material, warranties, call-up and deployment of the military police and fire brigades (Sec. 22, sub. 21).</p>
Chile (1980. Last reform 2010)		
Leading Political Procedures	Military Instrument	Other Provisions
<p><b>Powers of the President:</b> Maintain external security (Sec. 24). Appoint and remove the Commanders-in-Chief of the Army, the Navy and the Air Force (Sec. 32, sub. 16; Sec. 105). Appoint, promote and remove officers (Sec. 32, sub. 16). Arrange, organize and deploy the Armed Forces depending on national security needs (Sec. 32, sub. 17). Supreme Chief of the Armed Forces in times of war (Sec. 32, sub. 18). Declare war once the pertinent law has been adopted, and after hearing the National Defence Council (Sec. 32, sub. 19). Order payments not authorized by law to meet the pressing needs derived from external aggressions, internal conflict and serious harm or danger to national security (Sec. 32, sub. 20). Declare the state of assembly in case of external war, with the approval of the National Congress (Sec. 40). The President has the law initiative to establish the air, land and sea forces, and the ones for the entry and deployment of troops (Sec. 65; Sec. 63, sub. 13).</p> <p><b>Powers of Congress:</b> Indict (only Representatives) and judge (only Senators) Generals and Admirals (Sec. 52, sub. 2, d; Sec. 53, sub. 1). Approve or dismiss international treaties introduced by the President in order to be ratified (Sec. 54, sub. 1). The Chamber of Deputies (Lower House) has the lawmaking initiative regarding recruitment matters (Sec. 65).</p> <p><b>National Security Council<sup>5</sup>:</b> Advise the President on national security (Sec. 106).</p>	<p><b>The Armed Forces:</b> Composed of the Army, the Navy and the Air Force (Sec. 101). Mission: defend the Motherland (Sec. 101); safeguard the public order during elections (Sec. 18). The members of the military on active duty cannot be elected Deputies or Senators unless they resign and retire during the year preceding the election (Sec. 57, sub. 10). Depend on the National Ministry of Defence, they are essential to the national security, they are obedient, non deliberant, professional and disciplined, and follow a hierarchical order (Sec. 101). Incorporation to the Armed Forces is performed through their own schools, except in the case of professional scales and civilian personnel (Sec. 102). Obligatory military service (Sec. 22). Appointments, promotions, retirement of officers, ranks, incorporation, social security, seniority, command succession and budget are determined by constitutional organic law (Sec. 105). The right to a legal defence, in the administrative and disciplinary spheres, shall be governed by the relevant regulations of the respective bylaws (Sec. 19, inc. 3).</p>	<p>It is the duty of the State to safeguard the nation's security (Sec. 1). The Chilean nationality shall be lost by virtue of supreme decree, in case of service provision to the enemy or its allies during external war (Sec. 11, sub. 2). Freedom of teaching has no other limitations but those imposed by moral, good customs, public order and national security (Sec. 19, sub. 11). Associations which are contrary to moral, the public order and the security of the State are prohibited (Sec. 19, sub. 15). No government or city official, employee of corporations or companies providing public utility services or any worker whose stoppage might cause serious harm to national security shall be entitled to go on strike (Sec. 19, sub. 16). The law may allow certain taxes to be allocated to national defence (Sec. 19, sub. 20). Citizen participation: all Chileans have the fundamental duty to honour their Motherland, to defend its sovereignty and to contribute to preserve national security (Sec. 22). The exercise of rights and guarantees established in the Constitution can only be modified by the following exceptional circumstances: external or internal war, internal disorder, emergency and public catastrophe, seriously affecting the normal operation of State institutions (Sec. 39).</p>

3 Consejo da República. 4 Consejo de Defensa Nacional. 5 Consejo de Seguridad Nacional.



Colombia (1991. Last reform 2009)		
Leading Political Procedures	Military Instrument	Other Provisions
<p><b>Powers of the President:</b> Supreme Commander of the Armed Forces (Sec. 189, sub. 3). Conducts operations when deemed necessary (Sec. 189, sub. 5). Provide to external security (Sec. 189, sub. 6). Declare war with the approval of the Senate, except in case of foreign aggression and accord peace, informing Congress (Sec. 189, sub. 6). Allow, when the Senate is in recess, with the approval of the State Council, the transit of foreign troops through the territory of the Republic (Sec. 189, sub. 7).</p> <p><b>Powers of Congress:</b> Dictate general rules with objectives and criteria to establish wage levels and social benefits for the military (Sec. 150, sub. 19, e). Approve the appointment of senior officers (Sec. 173, sub. 2). Approve the entry of foreign troops (Sec. 173, sub. 4). Approve the declaration of war (Sec. 173, sub. 5).</p> <p><b>State Council<sup>6</sup>:</b> Act as the supreme advisory body of the Government in administration matters. In case of foreign troops transit through the national territory, and of stay or transit of foreign warships or combat aircraft in national waters or airspace, the government shall first take the advice of the State Council (Sec. 237, sub. 3).</p>	<p><b>The Military Forces<sup>7</sup>:</b> The Military Forces comprise the Army, the Navy and the Air Force (Sec. 217). Mission: defend the sovereignty, independence, integrity of the nation's territory and constitutional order (Sec. 217). The members of the military on active duty are not entitled to join labour unions (Sec. 39), vote, make petitions except on issues related to their service, or to participate in political activities and debates (Sec. 219). They cannot be elected as Congress members unless they have resigned and retired at least twelve months before the election (Sec. 179, sub. 2). The Commanders of the Military Forces cannot be elected President before one year following their previous position (Sec. 197). In case of a manifest violation of a constitutional rule to the disadvantage of any person, the responsibility shall fall exclusively on the superior who has issued the order (Sec. 91). Professional, cultural and social promotion systems for members of the public force shall be determined by law. The fundamentals of democracy and human rights shall be taught during the professional training phase (Sec. 222). Military justice for military crimes (Sec. 221, Sec. 250), civilians may not be tried by the Martial Law (Sec. 213).</p>	<p>The State is essentially aimed at defending independence and maintaining territorial integrity (Sec. 2). The State's foreign relations are based on national sovereignty, the respect for the self-determination of peoples, and the recognition of the principles of international law endorsed by Colombia. The foreign policy of Colombia shall be oriented to the integration of Latin America and the Caribbean (Sec. 9). Peace is a compulsory right and duty (Sec. 22). Colombian citizens shall be educated in the respect for human rights, peace and democracy (Sec. 67). It is prohibited to manufacture, import, possess and use chemical, biological and nuclear weapons, as well as to enter nuclear and toxic waste into national territory (Sec. 81). All Colombians are obliged to bear arms when public need requires the defence of the nation's independence and public institutions (Sec. 216). The Government is exclusively entitled to introduce and manufacture weapons, ammunitions and explosives. No person shall be entitled to own or carry weapons and the like without prior authorization of the relevant authority. (Sec. 223). The State shall promote economic, social and political integration with other nations, especially with Latin America and the Caribbean, through the execution of treaties which, based on equity, equality and reciprocity, create supranational bodies that may even lead to the creation of a Latin American community of nations (Sec. 227).</p>
Cuba (1976. Last reform 1992)		
Leading Political Procedures	Military Instrument	Other Provisions
<p><b>Powers of the National Assembly of People's Power<sup>8</sup>:</b> Approve the general foreign and domestic policy guidelines (Sec. 75, sub. h). Declare the state of war in case of military aggression and approve peace treaties (Sec. 75, sub. i).</p> <p><b>Powers of the State Council<sup>9</sup>:</b> Decree general mobilization when required for the defence of the country and assume the powers assigned to the National Assembly by the Constitution to declare war in case of aggression or make peace, when this Assembly is in recess or cannot be summoned with the necessary celerity and security conditions. (Sec. 90, sub. f).</p> <p><b>Powers of the President of the State Council and Head of State:</b> Preside over the National Defence Council (Sec. 93, sub. h).</p> <p><b>Powers of the Council of Ministers<sup>10</sup>:</b> Provide for national defence, maintenance of internal order and security, and the protection of human life and assets in case of natural disasters. (Sec. 98, sub. ch).</p> <p><b>National Defence Council<sup>11</sup>:</b> Convened and prepared in times of peace to lead the country under state-of-war conditions, during war, general mobilization or state of emergency. (Sec. 101).</p> <p><b>Local Bodies of the People's Power<sup>12</sup>:</b> The Province and Municipal Assemblies of the People's Power are responsible for reinforcing the defensive capacity of the country (Sec. 105 and Sec. 106, sub. m). The Defence Councils of the Provinces, Municipalities and Defence Zones are created and prepared in times of peace to lead their respective territories in a state of war, during the war, general mobilization or state of emergency, based on a general defence plan and the role and responsibilities of the army's military councils (Sec. 119).</p>	<p><b>Revolutionary Armed Forces<sup>13</sup>:</b> The members of the Revolutionary Armed Forces and other armed organizations have the right to vote and be elected as any Cuban citizen (Sec. 134).</p>	<p>All citizens have the right to fight with all means, including armed resources, when no other means are left, against anyone attempting to disrupt the political, social or economic order established by the Constitution (Sec. 3). The State sustains and defends the integrity and sovereignty of the Motherland (Sec. 9). The economic, diplomatic and political relations with other States shall never be negotiated under aggression, threat or coercion of a foreign power (Sec. 11). The Cuban Republic ratifies its desire that all States, whether big or small, weak or powerful, can enjoy a decent, actual and valid peace, based on the respect for independence and sovereignty of the people and the right to self-determination; it bases its international relations on the peaceful settlement of disputes on equal footing with other States, on the basis of respect and adherence to other principles established in the UN Charter; it reaffirms its willingness to promote integration and collaboration among countries in Latin America and the Caribbean; it condemns imperialism, promoter and supporter of all fascist, colonialist, neo-colonialist and racist manifestations, as the main force of war and aggression and the worst enemy of the peoples; it condemns the direct and indirect intervention on the internal or external affairs of any State, including armed aggressions, economic blockades and any other form of economic or political blockade; it views wars of aggression and conquest wars as international crimes and recognizes the legitimacy of struggles for national liberation, as well as of armed resistance to aggression, and considers its duty to support victims of aggression and people fighting for their liberation and self-determination (Sec. 12, sub. a, b, c, d, e and g). The State guarantees the right achieved by the Revolution by which all citizens, without distinction, can be promoted to all hierarchies of the Revolutionary Armed Forces, security and law-enforcement, according to their skills and merits (Sec. 43). The defence of the socialist nation is the greatest honour and supreme duty of every Cuban citizen. The military service is regulated by law (Sec. 65).</p>

6 Consejo de Estado. 7 Denomination used in the constitutional text. 8 Asamblea Nacional del Poder Popular. 9 Consejo de Estado. 10 Consejo de Ministros. 11 Consejo de Defensa Nacional. 12 Órganos locales del Poder Popular. 13 Fuerzas Armadas Revolucionarias.

Dominican Republic (2010)		
Leading Political Procedures	Military Instrument	Other Provisions
<p><b>Powers of the President:</b> Direct foreign and domestic policies and conduct civilian and military administration. Supreme authority of the Armed Forces (Sec. 128). Appoint or dismiss members of the military jurisdiction (Sec. 128, sub. 1, c). Enter into and sign international treaties or conventions and submit them for approval to the National Congress (Sec. 128, sub. 1, d). Decide on all issues related to the Armed Forces; lead the Armed forces directly or through the relevant ministry, always maintaining the supreme command thereof. Establish their strength and make use of the Armed forces to perform public service duties (Sec. 128, sub. 1, e). Take the necessary measures to provide and ensure the legitimate defence of the Nation, while informing the National Congress of any rules adopted (Sec. 128, sub. 1, f). Declare the states of exception if the National Congress were not in session (Sec. 128, sub. 1, g). Decide on anything related to the military zones (Sec. 128, sub. 1, i).</p> <p><b>Powers of the Congress:</b> Authorize (Senate) the presence of foreign troops to perform military exercises in the territory of the Republic, under the request of the President of the Republic, provided there is no previous agreement (Sec. 80, sub. 6), and approve and disapprove the deployment of national troops outside the country in peace missions authorized by international organizations (Sec. 80, sub. 7). Declare the state of national defence (Sec. 93, sub. 1, f). Determine, under the request of the President of the Republic, the creation of permanent public security or defence corps composed of members of the Armed Forces and the National Police, subordinated to the ministry or institution of the sphere of their respective competences in accordance with the law (Sec. 261).</p> <p><b>National Security and Defence Council<sup>14</sup>:</b> Advise the President of the Republic on the design of national security and defence policies and strategies and on any other matter requested by the President. The Executive shall regulate its make-up and operation (Sec. 258).</p>	<p><b>The Armed Forces:</b> The Armed Forces are responsible for the Nation's defence (Sec. 252). Their mission is to defend the independence and sovereignty of the Nation, the integrity of its geographical spaces, the Constitution and the institutions of the Republic (Sec. 252, sub. 1). Their nature shall be essentially defensive (Sec. 259). They shall intervene, as ordered by the President of the Republic, in programs intended to promote the social and economic development of the country, mitigate disasters or public catastrophe situations, and provide assistance to the National Police to maintain or restore public order in exceptional cases (Sec. 252, sub. 2). They are essentially obedient to the civil power, are not affiliated to any political party and are not entitled to deliberate under any circumstance (Sec. 252, sub. 3). The members of the military on active duty cannot run for President or Vice-President unless they have retired at least three years before the election (Sec. 123, sub. 4). The Armed Forces shall be responsible for the custody, supervision and control of all weapons, ammunitions and other military supplies, as well as war material and equipment, entering the country or produced by the national industry, subject to the restrictions established by law (Sec. 252). No discrimination shall be exerted in the admission, appointment, promotion and retirement of Armed Forces members, in accordance with their organic law and other complementary laws (Sec. 253). The military jurisdiction shall only have competence to try military infractions determined by the relevant laws. The Armed Forces shall have a military discipline regime applicable to those offences that do not constitute an infraction under the military criminal justice system (Sec. 254).</p>	<p>The sovereignty of the Dominican Republic, a State free and independent from any foreign power, is inviolable. The non-intervention principle constitutes an unchanging rule of Dominican foreign policy (Sec. 3). Border security is declared of supreme and permanent national interest (Sec. 10). The Dominican Republic accepts an international legal order that guarantees peace. It commits itself to perform actions in line with national interests, the peaceful coexistence among peoples and solidarity responsibilities towards all nations at an international, regional and national level (Sec. 26, sub. 4). The Dominican Republic shall promote and favour the integration with American nations in order to reinforce a community of nations that may defend their regional interests. The State shall sign international treaties to promote the common development of nations and ensure the welfare of their people and collective security of their inhabitants (Sec. 26, sub. 5). The introduction, development, production, possession, sale, transport, storage and use of chemical, biological and nuclear weapons shall be prohibited (Sec. 67, sub. 2). All acts performed by usurped power, actions or decisions made by public powers, institutions or any person disrupting or subverting the constitutional order, as well as any decision made upon request of the armed force shall be considered null and void (Art. 73). Citizens shall have the fundamental duties of rendering civil and military service as required by the Nation for its defence and preservation (Sec. 75, sub. 3) and shall refrain from doing any act detrimental to the stability, independence or sovereignty of the Dominican Republic (Sec. 75, sub. 5). Security and defence shall be regulated by the appropriate organic laws (Sec. 112).</p>
Ecuador (2008)		
Leading Political Procedures	Military Instrument	Other Provisions
<p><b>Powers of the President:</b> Exercise the highest authority of the Armed Forces and appoint the military senior staff (Sec. 147, sub. 16). Assume the political direction of the national defence (Sec. 147, sub. 17). Decree the state of exception in all or part of the national territory in case of aggression, international or internal armed conflict, grave internal unrest, public catastrophe or natural disaster (Sec. 164). Once the state of exception is declared, the President shall be entitled to make use of the Armed Forces and the National Police and summon the whole or part of the reserved forces, as well as personnel of other institutions, for active service (Sec. 165, sub. 6).</p> <p><b>Powers of the National Assembly<sup>15</sup>:</b> Approve or reject international treaties when appropriate (Sec. 120, sub. 8). The ratification or rejection of international treaties shall require prior approval of the National Assembly if: 1. They are related to territorial or border matters. 2. They establish any political or military alliance (Sec. 419).</p>	<p><b>Armed Forces:</b> Mission: defence of territorial sovereignty and integrity (Sec. 158). The Armed Forces and the National Police are institutions designed to protect citizens' human rights, liberties and guarantees. The members of the Armed Forces shall be trained in accordance with the fundamental principles of democracy and human rights, and shall respect the dignity and rights of the people (Sec. 158). They shall be obedient and non-deliberating and shall comply with their mission under strict observance of the civilian control and the Constitution. The Armed Forces senior leadership shall be responsible for their orders. Obedience to orders issued by senior officers of the Armed Forces shall not relieve subordinates from their responsibility (Art. 159). Voting shall not be compulsory for members of the Armed Forces (Sec. 62, inc. 2). Members of the force on active duty cannot be candidates for elections subject to popular vote nor ministers of State (Sec. 113, sub. 8 and Sec. 152, sub. 3). The recruitment of candidates to the armed forces shall not be based on discrimination. The members of the Armed Forces shall be subject to the specific laws regulating their rights and obligations, as well as their system of promotions based on merit and gender equality criteria. Their stability and professionalization shall be guaranteed (Sec. 160). Civil and military service is voluntary and shall be carried out under the respect of citizens' rights and diversity. All</p>	<p>Guarantee and defend national sovereignty is a fundamental duty of the State (Sec. 3, sub. 2). The central State shall have exclusive competence over national defence (Sec. 261, sub. 1). Ecuador is a territory of peace. No foreign military bases or foreign facilities with military purposes shall be established. The assignment of national military bases to foreign security forces or Armed Forces shall be forbidden (Sec. 5). The limitation of military activities in the territories of municipalities, communities, towns and indigenous peoples' territory is recognized and guaranteed in accordance with the law (Sec. 57, sub. 20). Every person has the right to refuse to use violence and to participate in the military service (Sec. 66). Legal actions and sentences for genocide, crimes against humanity, war crimes, the forced disappearance of persons or crimes of aggression against a State shall not be subject to limitation. None of these cases shall be eligible for amnesty. If these offences were committed by a subordinate, this shall not relieve the superior who gave the order nor the subordinate executing such order of criminal liability (Sec. 80). Ecuadoreans shall be responsible for defending Ecuador's territorial integrity and natural resources, and for collaborating with the maintenance of peace and security (Sec. 83, sub. 3 and 4). Both individuals and collective actors shall have the right to resist against actions or omissions of the public authority, non-state individuals or legal persons that infringe or might infringe their constitutional</p>

<sup>14</sup> Consejo de Seguridad y Defensa Nacional. <sup>15</sup> Asamblea Nacional.





Ecuador

	<p>kinds of forced recruitment are forbidden (161). The Armed Forces shall only be allowed to participate in economic activities related to the national defence and shall provide their resources to support national development in accordance with the law. Their reserves shall be organized based on the needs for the compliance of their duties. The State shall allocate the necessary resources for their equipment, training and education (Sec. 162). Military barracks are not places authorized for the custody of civil population (Sec. 203, sub. 1). The members of the Armed Forces shall make a sworn statement of their assets prior to any promotion or retirement (Sec. 231). The Armed Forces shall have a special social security regime in accordance with the law; their social security entities shall form part of the integral public health network and the social security system (Sec. 370). Disciplinary arrests of military members shall be conducted in accordance with the law (Sec. 77). The members of the Armed Forces shall be tried by the Judiciary Branch bodies; in the case of crimes committed while at a specific mission, they shall be tried by courts specialized in military matters, which form part of the same Judiciary Branch. Disciplinary offences shall be tried by the competent bodies established by law (Sec. 160). Under the principle of jurisdictional unit, Armed Force members shall be tried by the ordinary justice system (Sec. 188).</p>	<p>rights and demand the recognition of new rights (Sec. 98). Ecuador's relations with the international community shall respond to the interests of the Ecuadorean people. Thus, Ecuador proclaims the legal independence and equality of the States, the peaceful coexistence and self-determination of the peoples, and the spirit of cooperation, integration and solidarity among them; Ecuador supports the peaceful settlement of international conflicts and controversies, and rejects the threat or use of force as a means of settlement; it condemns State interference in other States' internal affairs as well as any kind of intervention, whether this be armed, aggression, occupation or an economic or military blockade; it promotes peace and universal disarmament; it condemns the development and use of weapons of mass destruction and the imposition of bases and facilities with military purposes by any State on other State's territory; it condemns all forms of imperialism, colonialism, neo-colonialism, and it recognizes the right of the peoples to resistance against, and liberation from, all forms of oppression; it recognizes international law as a norm of conduct and demands the democratization of all international bodies and equal participation of States within these bodies; it promotes political, cultural and economic integration of the Andean region, South America and Latin America above all (Sec. 416, sub. 1, 2, 3, 4, 8, 9 and 11). Integration, especially with Latin America and the Caribbean, shall be a strategic objective of the State. During all integration stages and processes, the Ecuadorean State shall be committed to promoting a common defence policy that will consolidate a strategic alliance to reinforce the sovereignty</p>
--	--	--

**El Salvador (1983, Last reform 2003)**

Leading Political Procedures	Military Instrument	Other Provisions
<p><b>Powers of the President:</b> General Commander of the Armed Force (Sec. 157). Maintain intact the sovereignty and integrity of the territory (Sec. 168, sub. 2). Sign treaties and international concordats, subjecting them to the Legislative Assembly (Sec. 168, sub. 4). Report on what the Assembly requires, except in the case of secret military plans (Sec. 168, sub. 7). Organize, maintain and arrange the Armed Forces, confer military ranks in accordance with the law (Sec. 168, sub. 11). Summon the Armed Force for the defence of national sovereignty and exceptionally, if no other means rest for the maintenance of internal peace, for the public security and tranquility of the State (Sec. 168, sub. 12). Direct war and accord peace treaties with the approval of the Assembly (Sec. 168, sub. 13). Determine the number of active troops of the Armed Forces on an annual basis (Sec. 168, sub.19).</p> <p><b>Powers of the Legislative Assembly<sup>16</sup>:</b> In case of invasion, legally declared war or public calamity, the Assembly shall impose obligatory loans if ordinary public taxes are not enough to cover the costs (Sec. 131, sub. 6). Declare war and authorize the President to make peace (Sec. 131, sub. 25). Approve or dismiss the transit of foreign troops on the national territory, (Sec. 131, sub. 29).</p> <p><b>Executive Body on the Branch of Defence and Public Security<sup>17</sup>:</b> Determine the number of troops annually according to the needs of the service (Sec. 213).</p>	<p><b>The Armed Force<sup>18</sup>:</b> It is a permanent institution at the service of the Nation. It is obedient, professional, apolitical and non-deliberating (Sec. 211). Its mission is to defend the sovereignty of the State and the integrity of the territory. The main government branches, the Legislative, the Executive and the Judiciary, may use the Armed Forces to enforce any resolutions adopted within their respective jurisdictions, to ensure full compliance with the Constitution. The Armed Force shall cooperate with efforts of public benefit assigned by the Executive Power and shall help the people in case of a national disaster (Sec. 212). The Armed Force is obliged to cooperate with the special commissions of the Legislative Assembly (Sec. 132). It is part of the Executive branch and it is subordinated to the authority of the President as General Commander in chief. Its structure, legal system, doctrine, organization and operation are determined by law, rules and special regulations the President adopts (Sec. 213). The military professional career and promotions are strictly based on rank and in accordance with the law (Sec. 214). Military service is obligatory (Sec. 215). The members of the military on active duty cannot be part of any political party, or be candidates for elections. They can only be elected President three years after they retire (Sec. 82; Sec. 127; Sec. 152). Military justice jurisdiction: purely military crimes and offences (Sec. 216).</p>	<p>Armed political, religious or union groups are prohibited (Sec. 7). Death penalty shall only be imposed in the cases specified by the military laws during the state of international war (Sec. 27). El Salvador fosters and promotes human, economic, social and cultural integration with the American republics, especially with those in the Central American Isthmus (Sec. 89). The State shall be entitled to seize the properties of citizens from countries at war with El Salvador (Sec. 112). National defence and public security shall be assigned to different Ministries (Sec. 159). Citizen participation: all the citizens of El Salvador fit for military tasks shall be soldiers in case of need (Sec. 215). The manufacturing, import, export, sale, possession and carrying of weapons, ammunitions, explosives and similar items shall only be allowed with the authorization and under the direct supervision of the defence organization of the Executive Body. A specific law shall regulate this matter (Sec. 217). Civil public services shall only be militarized in case of national emergency (Sec. 221).</p>

**Guatemala (1985, Last reform 1993)**

Leading Political Procedures	Military Instrument	Other Provisions
<p><b>Powers of the President:</b> General Commander of the Army (Sec. 182, 183 and 246). Give orders via the general officer or colonel or his equivalent at the Navy, who serves as Minister of National Defence (Sec. 246). Provide for the defence and security of the Nation (Sec. 183, sub. b). Confer promotions, decorations, military honours and extraordinary pensions (Sec. 246, sub. b). Decree the mobilization and demobilization of troops (Sec. 246 sub. a).</p>	<p><b>The Army<sup>19</sup>:</b> It is unique and indivisible, essentially professional, apolitical, obedient and non deliberant. It is composed of the land, air and maritime forces. Organization: hierarchy, based on the principles of discipline and obedience (Sec. 244). It is regulated by the Constitution, its Statutory Law and other military laws and regulations (Sec. 250). They are not obliged to carry out illegal orders or those which involve committing a crime (Sec. 156). Mission: maintain independence, sovereignty and</p>	<p>Citizen participation: to serve and defend the Nation and to provide social and military service are the rights and responsibilities of every citizen of Guatemala (Sec. 135). Guatemala shall regulate its relations with other States in accordance with international principles, rules and practices in order to contribute to peace-keeping and freedom, the respect and defence of human rights, the strengthening of democratic processes and international institutions which can guarantee the mutual and equal benefit among</p>

<sup>16</sup> Asamblea Legislativa. <sup>17</sup> Órgano Ejecutivo en el Ramo de Defensa y Seguridad Pública. <sup>18</sup> Denomination used in the constitutional text. <sup>19</sup> Denomination used in the constitutional text.

Guatemala

<p><b>Powers of the Congress:</b>                  Declare war and sign peace treaties (Sec. 171, sub. f). Approve the transit of foreign troops on the national territory and the sojourn of foreign military (Sec. 172, sub. a). Approve treaties which affect or may affect the security of the State or conclude a state of war (Sec. 172, sub. b). The Army depends on the Congress if the President continues in the position once the constitutional period has come to an end and is not recognised by the Congress (Sec. 165, sub. g). The ministers of State are not obliged to come forward to the Congress to answer questions related to diplomatic issues or pending military operations (Sec. 166).</p>	<p>the honour of Guatemala, the integrity of the territory and internal and external peace and security (Sec. 244); cooperate in emergency situations or public calamity (Sec. 249). To be an officer it is required to be a native Guatemalan citizen and not have adopted any foreign nationality at any time (Sec. 247). The members of the military on active duty cannot be elected Deputies (Sec. 164, sub. f) or President, only if they were discharged or retired five years before taking office (Sec. 186, sub. e), they are not entitled to vote or to make political or collective petitions (Sec. 248). The military courts shall acknowledge the crimes of faults committed by the members of the Guatemalan Army (Sec. 219).</p>	<p>States (Sec. 149). Administrative actions are public, except those related to military or diplomatic matters of national security (Sec. 30). They are not obliged to carry out illegal orders or those which involve committing a crime (Sec. 156). The whip or commanders of a coup d'état, armed revolution or the like who altered the constitutional order shall not be eligible as President or Vice president (Sec. 186). The organization and operation of armed groups not regulated by the laws of the Republic and its regulations constitute a punishable action (Sec. 245). The Executive has the power to enter into negotiations to settle the situation regarding Guatemala's rights with respect to Belize, in accordance with national interests. (Temporary and final provisions, Sec. 19).</p>
--	--	--

**Honduras (1982, Last reform 2005)**

Leading Political Procedures	Military Instrument	Other Provisions
<p><b>Powers of the President:</b>                  General Commander of the Armed Forces, exercises the Command-in-Chief (Sec. 245, sub. 16; Sec. 277). Maintain the peace and external security; repel external attacks or aggression (Sec. 245, sub. 4), adopt measures for the defence of the Republic (Sec. 245, sub. 16). Declare war and make peace if the Congress is in recess (Sec. 245, sub. 17). Sign international treaties and agreements of a military nature, regarding the territory and sovereignty with the consent of the Congress (Sec. 245, sub. 13). Allow the transit of foreign troops on the national territory and the deployment of national troops outside the country with the approval of the Congress (Sec. 245, sub. 43 and 44). Confer military ranks (second lieutenant to captain) suggested by the Secretary of National Defence (Sec. 245, sub. 36; Sec. 290). Ensure that the Armed Forces are apolitical, essentially professional, obedient and non deliberant (Sec. 245, sub. 37).</p> <p><b>Powers of the Congress:</b>                  Declare war and make peace (Sec. 205, sub. 28). Confer military ranks (from major to general) suggested by the Executive Power (Sec. 205, sub. 24; Sec. 290). Approve the entry of foreign troops to the national territory and the deployment of national troops outside the country (Sec. 205, sub. 26 and 27). Determine the number of permanent troops (Sec. 205, sub. 25). Authorize reception of foreign military missions of assistance or technical cooperation in Honduras (Sec. 205, sub. 29).</p> <p><b>Secretary of State in the National Defence Dispatch<sup>20</sup>:</b>                  The Secretary shall be appointed and removed freely by the President of the Republic (Sec. 280).</p> <p><b>National Defence and Security Council<sup>21</sup>:</b>                  Creation (Sec. 287). Organization and operation determined by law (Sec. 287).</p> <p><b>Board of Commanders of the Armed Forces<sup>22</sup>:</b>                  It is the consulting body for all the matters related to the Armed Forces. It rules over issues of its competence and acts as a Superior tribunal of the Armed Forces on matters which shall be subject to its knowledge. The Statutory Law of the Armed Forces and its Regulations rule over its operation (Sec. 285). It is composed of the Chairman of the Joint Chief of Staff, the General Inspector and the Commanders of each Force (Sec. 286).</p> <p><b>Joint Chief of Staff of the Armed Forces<sup>23</sup>:</b>                  The Chairman of the Joint Chief of Staff is selected and removed freely by the President among the members of the Board of Commanders (Sec. 280). The Joint Chiefs of Staff is the superior technical body of consultation, planning, coordination and supervision, which depends on the Secretary of National Defence; its tasks are assigned by the Statutory Law of the Armed Forces (Sec. 283). It shall issue a statement previous to conferring the promotions to the officers (Sec. 290).</p>	<p><b>The Armed Forces:</b>                  They are permanent, apolitical, essentially professional, obedient and non deliberant (Sec. 272). They are composed of the High Command, the Army, the Air Force, the Navy, the Public Security Force and other organizations determined by the Statutory Law (Sec. 273). Their operation is regulated by the Statutory Law, laws and regulations (Sec. 274). The orders given by the President of the Republic shall be abided by and executed respecting the Constitution of the Republic and the principles of lawfulness, discipline and military professionalism (Sec. 278). The members of the military are not obliged to carry out illegal orders or those which involve committing a crime (Sec. 323). They have been established to defend territorial integrity and the sovereignty of the Republic, keep the peace, public order and the respect of the Constitution, the principles of free vote, rotation of the Presidents of the Republic (Sec. 272), cooperate with the National Police in the keeping of the public order (Sec. 272); and with the Secretaries if required so in tasks of literacy, education, agriculture, protection of the environment, road systems, communication, health and agricultural reform. Participate in international peace missions; in the fight against drug trafficking; cooperate with means and personnel to face natural disaster and emergency situations; as well as protection and conservation programs for the ecosystem, for the academic and technical training of their members, and others of national interest. Cooperate with the public security institutions at the request of the Secretary of Security, to fight terrorism, arms trafficking and organized crime, as well as protection of the powers of the State and Elections Tribunal, operating at its request (Sec. 274). Promotions strictly determined by law (Sec. 290). Appointments and removal of the members of the military, related with the administrative order, shall be granted in accordance with the Law of Public Administration. In the operative area, appointments and removals shall be conferred by the Chairman of the Joint Chief of Staff, in accordance with the organic structure of the Armed Forces, the Statutory Law, and other legal regulations, including the personnel of troops and auxiliaries (Sec. 282). Voluntary military service (Sec. 276 and 288). The members of the military on active duty are not entitled to vote (Sec. 37), and they shall be eligible in the cases not prohibited by the law (Sec. 37). They cannot be elected Deputies prior to six months after they retire (Sec. 199, sub. 4 and 6) or twelve months in case they are running for President (Sec. 240, sub. 2, 3 and 4). National Defence College: it is the highest house of studies for the Armed Forces. It trains selected military and civilian personnel, so they take part in the national strategic planning (Sec. 289). Institute of Military Social Security: for the protection, welfare and social security of all the members of the military, presided by the Chairman of the Joint Chief of Staff, shall operate in accordance with the specific Law (Sec. 291). For defence and national security reasons, the territory shall be divided in military regions commanded</p>	<p>Citizen participation: every Honduran citizen is obliged to defend the Motherland (Sec. 38; Sec. 276). Military service is a citizen's duty. It is voluntary in times of peace, under a social, humanitarian and democratic education system. The State can summon the troops, in accordance with the Military Service Law. In case of international war, all the citizens capable of defending and service the Motherland shall be soldiers (Sec. 40, sub. 5; Sec. 276). The people can uprise in defence of the constitutional order (Sec. 3). Embrace the principles and practices of the international law which support human solidarity, the respect for self determination, the non-intervention and strengthening of universal peace and democracy. Honduras proclaims the validity and obligatory execution of arbitrations and judiciary international sentences as unavoidable (Sec. 15). No authority can sign or ratify treaties or grant licences which compromise territorial integrity, sovereignty and the independence of the Republic. Whoever does this shall be tried for treason to the Nation. Responsibility in this case is imprescriptible (Sec. 19).</p>

20 Secretario de Estado en el Despacho de Defensa Nacional. 21 Consejo Nacional de Defensa y Seguridad. 22 Consejo Superior de las Fuerzas Armadas. 23 Jefe del Estado Mayor Conjunto de las Fuerzas Armadas.



Honduras

	by a Chief of Military Region. Their organization and operation shall be in accordance with the Statutory Law of the Armed Forces (Sec. 284). Military justice for military crimes and offences (Sec. 90 and Sec. 91). A special law shall regulate the operation of military courts (Sec. 275).	
--	--	--

**Mexico (1917. Last reform 2007)**

Leading Political Procedures	Military Instrument	Other Provisions
<p><b>Powers of the President:</b>                      Appoint colonels and other senior officers with the approval of the Senate (Sec. 89, sub. IV) and other officers (Sec. 89, sub. V).                      Declare war with the approval of the Congress (Sec. 89, sub. VIII).                      Make use of the permanent Armed Forces and the National Guard to safeguard the security and external defence (Sec. 89, sub. VI and VII).                      Direct foreign policy and sign International agreements (Sec. 89, sub. X).</p> <p><b>Powers of the Congress:</b>                      The Chamber of Deputies has the law initiative on recruitment of troops (Sec. 72, sub. h).                      Declare war in view of the information submitted by the Executive Power (Sec. 73, sub. XII).                      Raise and maintain the Armed institutions and regulate their organization and service (Sec. 73, sub. XIV).                      Enact laws on national security (Sec. 73, sub. XXIX-M).                      Approve (Senate) international treaties and conventions subscribed by the Executive Power, as well as conclude, denounce, suspend, modify, amend, withdraw reserves and formulate interpretations (Sec. 76, sub. I).                      Approve the appointment of senior officers (Sec. 76, sub. II; Sec. 89, sub. IV).                      Approve the transit of foreign troops on the national territory and the deployment of national troops outside the country, and the sojourn of squadrons of other powers in Mexican waters (Sec. 76, sub. III).</p>	<p><b>The Armed Force<sup>24</sup>:</b>                      To join the Army in times of peace or the Navy and Air Force at all times it is required to be a Mexican citizen by birth (Sec. 32).                      It is composed of the Army, the Navy and the Air Force (Sec. 89, sub. VI).                      Members of the military cannot be elected Deputies unless they retire ninety days before the election (Sec. 55, sub. V) or six months in case of the President (Sec. 82, sub. V).                      In times of peace, no military authority may perform any functions other than those that are directly connected with military discipline (Sec. 129).                      Crimes and offences against military discipline shall be tried by military courts; however, under no circumstances and for no reason shall military courts extend their jurisdiction over persons who are not members of the Army (Sec. 13).</p>	<p>No armed reunion has the right to deliberate (Sec. 9).                      No member of the Army shall in time of peace be quartered in private dwellings without the consent of the owner, nor may he impose any obligation whatsoever. In time of war the military may demand lodging, equipment, provisions and other assistance in accordance with the respective martial law (Sec. 16).                      Nuclear energy shall only be used with peaceful purposes (Sec. 27).                      It is the obligation of every Mexican citizen to: I. Ensure their children or wards receive military education as established by law. II. Attend the training sessions organized by their local Council at the scheduled date and time in order to receive civic and military training on the exercise of their citizens' rights, the use of weapons and military discipline. III. Join and serve in the National Guard in accordance with the applicable organic law to ensure and defend the Nation's independence, territory, honour, rights and interests, as well as internal order and peace (Sec. 31).                      To bear weapons in the Army or National Guard for the defence of the Republic and its institutions, in accordance with the law, shall be a citizen prerogative (Sec. 35, sub. 4).                      Foreign policy shall be governed by the following regulatory principles: self-determination of the people; non-intervention; peaceful resolution of disputes; prohibition of the use of threat or force in international relations; legal equality of the States; international cooperation for development; and the struggle for international peace and security (Sec. 89, sub. 10).</p>

**Nicaragua (1986, Last reform 2007)**

Leading Political Procedures	Military Instrument	Other Provisions
<p><b>Powers of the President:</b>                      Supreme Commander of the Army (Sec. 95 and 144).                      In exceptional cases can the President, in a Council of Ministers, order the intervention of the Nicaraguan Army to support the National Police, when the stability of the Republic is threatened by serious internal disorder, calamities or natural disasters (Sec. 92).                      Direct international relations of the Republic. Negotiate, celebrate and sign treaties, pacts, agreements or the like to be approved by the National Assembly (Sec. 150, sub. 8).</p> <p><b>Powers of the National Assembly<sup>25</sup>:</b>                      Approve the deployment of national troops outside the country (Sec. 138, sub. 26) and the entry of foreign troops only for humanitarian purposes (Sec. 92).                      Approve or dismiss international agreements celebrated with countries or organizations subject to International Law (Sec. 138, sub. 12).</p>	<p><b>The Army<sup>26</sup>:</b>                      Mission: defend sovereignty, independence and territorial integrity (Sec. 92).                      It is a national institution, professional, not affiliated to any political party, obedient and non deliberrant. The members of the Army shall be trained in civic and human rights matters (Sec. 93).                      Organization, structures, activities, ranks, promotions, retirements and everything related to the operational development is specified in the law (Sec. 94).                      It is strictly subject to the Political Constitution, to which it respects and obeys, it is subject to civil authority exercised by the President or through the corresponding ministry. No other armed corps can exist in the national territory, or military ranks other than those specified by law (Sec. 95).                      They are not allowed to perform activities of political espionage (Sec. 96).                      They cannot perform political activities or hold a position in political organizations; they cannot be eligible for public office at elections, if they have not left their active military post at least a year before the elections (Sec. 94); they cannot be ministers, Vice Ministers, presidents or directors of government or autonomous entities, ambassadors (Sec. 152) and magistrates of tribunals of justice (Sec. 161, sub. 6) or of the Supreme Electoral Council (Sec. 171, sub. d). In the last two cases they shall leave their post twelve months before the elections.                      Military service is not obligatory, and all kinds of forcible recruitment to be a part of the Army or the Police are forbidden (Sec. 96).                      Military justice for military crimes committed by members of the Armed Forces, civilians cannot be tried by military courts (Sec. 93 and 159).</p>	<p>The strife over peace is one of the unrenounceable principles of the Nation (Sec. 3).                      The international relations are based on friendship and solidarity among the people and the reciprocity among the States. Thus, all kind of political, military, economic, cultural and religious aggression is inhibited and prohibited, as is the intervention on internal affairs of other States. It recognises the principle of peaceful resolution of international controversies through the international law and proscribes the use of nuclear weapons and other means of mass destruction in internal and International conflicts, ensures political asylum for political reasons, and rejects all subordination of a State with respect to other (Sec. 5).                      It is prohibited to establish foreign military bases in the national territory (Sec. 92).                      Civilian functions shall not be militarized (Sec. 131).</p>

24 Denomination used in the constitutional text. 25 *Asamblea Nacional*. 26 Denomination used in the constitutional text.

Paraguay (1992)		
Leading Political Procedures	Military Instrument	Other Provisions
<p><b>Powers of the President:</b> Commander-in-Chief of the Armed Forces (Sec. 238, sub. 9). Adopt the necessary measures for the national defence (Sec. 238, sub. 9). Declare the state of national defence, in case of external aggression, with the approval of the Congress (Sec. 238, sub. 7). Make peace with the approval of the Congress (Sec. 238, sub. 7). Appoint senior officers of the public force (Sec. 238, sub. 9). Issue military regulations and arrange, organise and distribute the Armed Forces (Sec. 238, sub. 9).</p> <p><b>Powers of the Congress:</b> Approve or dismiss international treaties (Sec. 141 and Sec. 202, sub. 9). Approve the appointment of senior officers (Senate) (Sec. 224, sub. 2). Authorize the entry of foreign troops to the territory of the Republic and allow the deployment of national armed forces outside the country, except in cases where this is required for courtesy reasons. (Sec. 183 sub.3). Approve the entry of foreign troops to the national territory and the deployment of national troops outside the country (Senate) (Sec. 224, sub. 5).</p>	<p><b>The Armed Forces:</b> They are a permanent, professional, non deliberant and obedient institution, subordinated to the powers of the State, to the provisions of the Constitution, and to the law (Sec. 173). Mission: safeguard the territorial integrity and defend the legitimately constituted authorities (Sec. 173). The members of the military on active duty will conform their actions to the laws and regulations (Sec. 173). Military service is compulsory and must be based on full respect of human dignity. In times of peace, it will not exceed twelve months (Sec. 129). They cannot be affiliated to any political party or movement or engage in any type of political activity (Sec. 173); they cannot be elected President or Vice President, except for those who retire at least one year prior to the day of election (Sec. 235, sub. 7). Police or military personnel on active duty cannot be candidates for senators or deputies (Sec. 197). Military courts will hear only crimes and offences of a military nature, committed by military personnel on active duty. Their decisions can be overturned by courts of law (Sec. 174). Only in cases of an armed international conflict can military courts have jurisdiction over civilians and retired military personnel (Sec. 174).</p>	<p>The manufacturing, assembly, import, sale, possession or use of nuclear, chemical and biological weapons is prohibited (Sec. 8). National defence cannot be subjected to referendum (Sec. 122, sub. 3). Citizen participation: every Paraguayan citizen is obliged to be prepared and give his services for the defence of the Motherland (Sec. 129). "Chaco" War veterans and veterans of other international armed conflicts shall enjoy honours and privileges, and shall receive pensions, comprehensive free preferential health care, and other benefits determined by law (Sec. 130). In its international affairs, Paraguay accepts the international law and endorses the following principles: 1. national independence; 2. self-determination of the people; 3. legal equality among all States; 4. international solidarity and cooperation; 5. international protection of human rights; 6. free navigation of international rivers; 7. non-intervention, and 8. the condemnation of every form of dictatorship, colonialism and imperialism (Sec. 143). Relinquishes war but upholds the principle of legitimate self-defence (Sec. 144). On equal footing with other States, admits a supranational legal system that guarantees the enforcement of human rights, peace, justice, and cooperation, as well as political, socioeconomic, and cultural development. Decisions on this sphere can only be adopted through an absolute majority vote by each Chamber of Congress (Sec. 145).</p>
Peru (1993. Last reform 2009)		
Leading Political Procedures	Military Instrument	Other Provisions
<p><b>Powers of the President:</b> Ensure external security (Sec. 118, sub. 4). Preside the national defence system; organize, deploy and arrange the Armed Forces (Sec. 118, sub. 14). Adopt the necessary measures to ensure the defence of the Republic, the integrity of the territory and the sovereignty of the State (Sec. 118, sub. 15). Declare war and accord peace with the approval of the Congress (Sec. 118, sub. 16). Authorise Peruvians to serve in a foreign army (Sec. 118, sub. 23). Supreme Commander of the Armed Forces (Sec. 164 and Sec. 167). Grant promotions to Generals and Admirals (Sec. 172). Determine the number of troops (Sec. 172). Declare the state of siege in case of invasion, foreign or civil war, in accordance with the Council of Ministers (Sec. 137). Sign international treaties on national defence (Sec. 56, sub. 3).</p> <p><b>Powers of the Congress:</b> Approve international treaties on national defence (Sec. 56, sub. 3). Have the troops available as requested by the President of the Congress (Sec. 98). Approve the entry of foreign troops to the national territory as long as it does not affect the national sovereignty in any way (Sec. 102, sub. 8). Approve the declaration of war and the signing of peace treaties (Sec. 118, sub. 16).</p>	<p><b>The Armed Forces:</b> The Armed Forces are composed of the Army, the Navy and the Air Force (Sec. 165). Mission: guarantee the independence, sovereignty and territorial integrity, to take control of the internal order in state of emergency if so provided by the President (Sec. 165). The respective laws and regulations determine the organization, functions, specialization, training, use and discipline (Sec. 168). They are non deliberant and are subordinated to the constitutional power (Sec. 169). The ethical and civic training and the teaching of the Constitution and human rights are compulsory both in the civilian and military education process. (Sec. 14). The members of the military are not entitled to make collective petitions (Sec. 2, sub. 20). They cannot run for elections) or perform political activities while on active duty (Sec. 34); to set up unions or go on strike (Sec. 42). Members of the Armed Forces on active duty cannot be elected members of Parliament unless they have retired six (6) months prior to the election (Sec. 91, sub. 4). They may not enter the floor of Congress without authorization from its President (Sec. 98). They can be ministers of State (Sec. 124). The law allocates funds for the logistical requirements of the Armed Forces (Sec. 170). The Armed Forces and the National Police participate in the social and economic development of the country, and in civil defence according to the law (Sec. 171). Military justice is established for the Armed Forces and the National Police (Sec. 139, sub. 1). Military courts may have jurisdiction over civilians in the cases of treason and terrorism (Sec. 173).</p>	<p>Any person shall have the right to request, without stating the reason, any information needed, within the legally specified time and cost. Exceptions are made of information affecting personal privacy and that is expressly excluded by law for reasons of national security (Sec. 2, sub. 5). The defence of national sovereignty is one of the prime duties of the State (Sec. 44). No person, organization, Armed Force, National Police or group of people may arrogate to themselves the exercise of the power of the State. To do so constitutes acts of rebellion or sedition (Sec. 45). No person owes obedience to a usurping government, nor to any member of government assuming public functions in violation of the laws and the Constitution. The civilian population has the right to resort to insurgency in defence of the constitutional order. Any act usurping public functions shall be considered null and void (Sec. 46). The death penalty may only be applied for the crimes of treason in wartime, and of terrorism, in accordance with the laws and treaties Peru is bound to (Sec. 140). The State guarantees the security of the Nation through a national defence system. National defence is integral and permanent and is developed both in the internal and external spheres. All natural and legal persons are obliged to participate in accordance with the law (Sec. 163). Only the members of the Armed Forces and the National Police are entitled to possess and use weapons of war. All existing weapons, as well as those manufactured in or introduced into the country, shall be property of the State without any proceeding or indemnity, except for weapons of war manufactured by the private industry in the cases determined by law. The law regulates the manufacturing, sale, possession and use of non-war firearms by individuals (Sec. 175).</p>
Uruguay (1967. Last reform 2004)		
Leading Political Procedures	Military Instrument	Other Provisions
<p><b>Powers of the President:</b> Maintain and defend external security (Sec. 168, sub. 1). Command the Armed Forces (Sec. 168, sub. 2). Provide military posts and confer promotions, Grant retirements and manage pensions for civil and military employees in accordance with the law (Sec. 168, sub. 3, 9 and 11). Order to break off relations and, based on a prior</p>	<p><b>The Armed Forces:</b> The members of the military are regulated by special laws (Sec. 59, sub. A). Members of the military on active duty cannot have a position in the government, form part of commissions or political parties, subscribe to party manifests, authorize the use of their name and execute any other public or private political act, except vot-</p>	<p>A clause by which all disputes among contracting parties should be settled through arbitration or other peaceful means shall be proposed for international treaties; it shall provide social and economic integration of the Latin American States, especially regarding common defence of its commodities, goods and resources. Furthermore, it shall provide for the effective complementation of its public ser-</p>



Uruguay

<p>resolution by the General Assembly, declare war if arbitration or other peaceful means have not been effective to avert a war (Sec. 168, sub. 16). Take prompt security measures in serious unexpected events of external attack or internal unrest, upon informing the General Assembly (Sec. 168, sub. 17). Enter into and sign treaties, which shall later be ratified with the approval of the Legislative Branch (Sec. 168, sub. 20).</p> <p><b>Powers of the General Assembly<sup>27</sup>:</b>                  Declare war and approve peace treaties (Sec. 85, sub. 7).                  Approve the appointment of senior officers (Sec. 168, sub. 11).                  Approve the entry of foreign troops to the national territory and the deployment of national troops outside the country (Sec. 85, sub. 11 y 12).                  Approve the number of Armed Forces personnel (Sec. 85, Sub. 8).                  Establish militia regulations and determine time and number of recruitment (Sec. 85, sub. 15).</p>	<p>ing (Sec. 77, sub. 4).                  They cannot run for the election of Representatives (Sec. 91, sub. 2; Sec. 92), Senators (Sec. 100) or for President (Sec. 171) unless they resign and retire at least three months before the election.                  Military justice for military crimes in state of war. Common crimes committed by members of the Armed Forces in times of peace, wherever they are committed, shall be subject to ordinary justice (Sec. 253).</p>	<p>ices (Sec. 6).                  Nobody shall be obliged to provide assistance, of any kind, or provide lodging to the Armed Forces, if it has not been specified by a civil magistrate in accordance with the law, and shall receive a compensation from the Republic for the perjury which would result from such actions (Sec. 35).</p>
---	--	--

**Venezuela (1999)**

Leading Political Procedures	Military Instrument	Other Provisions
<p><b>Powers of the President:</b>                  Commander-in-Chief of the National Armed Force. Exercise the highest authority (Sec. 236, sub. 5) and the supreme command (Sub. 236, sub. 6).                  Establish the armed forces strength (Sec. 236, sub. 5).                  Promote officers starting at the rank of colonel or naval captain and appoint them to the positions exclusively reserved to them (Sec. 236, sub. 6).                  Convene and preside over meetings of the National Defence Council (Sec. 236, sub. 23).                  The President of the Republic, in a Council of Ministers, can declare the state of exception (Sec. 337).                  The President can declare the state of internal or external emergency in case of internal or external conflict seriously endangering the security of the Nation, its citizens or institutions (Sec. 338).</p> <p><b>Powers of the National Assembly<sup>28</sup>:</b>                  Authorize the operation of military missions abroad or foreign military missions within the country (Sec. 187, sub. 11).                  Approve any international treaties or agreements signed by the National Executive (Sec. 187, sub. 18).</p> <p><b>National Defence Council<sup>29</sup>:</b>                  It is the highest consultative body for planning and advising the Public Authority on matters related to the integral defence of the Nation, its sovereignty and the integrity of its geographical space and it establishes the strategic concept of the Nation. It is presided over by the President and includes the Vice President, the President of the National Assembly, the Chairman of the Supreme Tribunal of Justice, the Chairman of the Republican Moral Council, and the Ministers of Defence, Internal Security, Foreign Affairs and Planning, and other whose participation may be deemed appropriate (Sec. 323).</p>	<p><b>The National Armed Force<sup>30</sup>:</b>                  It is an essentially professional institution, with no political orientation, organized by the State, at the exclusive service of the Nation. It is founded on discipline, obedience and subordination. The National Armed Force is composed of the Army, the Navy, the Air Force and the National Guard Its mission is to guarantee the independence and sovereignty of the Nation and ensure the integrity of its geographical space, through military defence, cooperation in the maintenance of internal order, and active participation in national development (Sec. 328).                  Their essential responsibility is the planning, execution and control of military operations, as required to ensure the defence of the Nation. The National Guard shall cooperate in the development of these operations and shall have as basic responsibility that of conducting operations as required maintaining internal order within the country. The National Armed Force shall carry out activities of administrative policing and criminal investigation as provided by law (Sec.329).                  Members of the military on active duty can vote. They are not allowed to run for elections, or to participate in propaganda, militancy or proselytizing (Sec. 330).                  It shall regulate and control, in accordance with the pertinent legislation, the manufacture, importing, exporting, storage, transit, registration, control, inspection, trade, possession and use of weapons, ammunition and explosives (Sec. 324).                  Military promotions shall be effective in accordance with merit, hierarchy and vacancies. They are the exclusive prerogative of National Armed Forces in accordance with the corresponding law (Sec. 331).                  Military justice for military crimes, its judges shall be elected by competitive procedures (Sec. 261).                  The General Controller of the National Armed Forces: monitors, controls and audits revenues, expenses and property allocated to the National Armed Force and their dependencies; it shall be under the responsibility of the General Controller of the Armed Forces, appointed by means of a competitive process (Sec. 291).</p>	<p>Promotes peaceful cooperation among nations, and strengthens and furthers nuclear disarmament (Preamble).                  The main objective of the State is to create a peace-loving society (Sec. 3).                  The geographical space of Venezuela is an area of peace, no foreign military bases, or facilities having purposes that are in any way military, shall be established within such space by any power or coalition of powers (Sec. 13).                  The public authorities, whether military or civilian, even during a state of emergency, exception or restriction of guarantees, are prohibited from effecting, permitting or tolerating the forced disappearance of persons. The officer receiving an order or instruction to carry it out has the obligation not to obey and report the order or instruction to the competent authorities (Sec. 45).                  The State shall prevent the manufacturing and use of nuclear and chemical or biological weapons (Sec. 129).                  Every person, in accordance with the law, has the duty to perform such civilian or military service as maybe necessary for the defence, preservation and development of the country, or to deal with situations involving a public calamity, no one shall be subject to forcible recruitment (Sec. 134).                  The Republic shall promote and encourage Latin America and Caribbean integration, in the interest of advancing towards the creation of a community of nations, defending the region's economic, social, cultural, political and environmental interests. The Republic shall sign international treaties that implement and coordinate efforts to promote the common development of our nations, and ensure the welfare of their people and the collective security of their inhabitants (Sec. 153).                  A clause shall be added to international treaties, covenants and agreements, establishing that potential disputes among the parties shall be solved through peaceful means accepted by international law or previously agreed upon by the parties (Sec. 155).                  National security is an essential competence and responsibility of the State (Sec. 322).                  The National Executive reserves the right to classify and control the disclosure of information directly related to the planning and execution of operations concerning the security of the Nation, on such terms as may be established by law (Sec. 325).                  National security is based on the shared responsibility between the State and civil society (Sec. 326).                  Securing the borders is a priority for compliance and application of national security principles. To that effect, a security fringe is established in the borders (Sec. 327).</p>

27 Asamblea General. 28 Asamblea Nacional. 29 Consejo de Defensa de la Nación. 30 Fuerza Armada Nacional.

**Source:** Compilation based on the Constitution of each country.

## National Legislation

<b>Argentina</b>	
Systems and Concepts	Military Organization
<ul style="list-style-type: none"> <li>- National Defence Act (N° 23.554 - 1988/05/05)</li> <li>- Internal Security Act (N° 24.059 - 1992/01/17)</li> <li>- Ministerial Law (N° 22.520 - 1992/03/20)</li> <li>- Act on the Restructuring of the Armed Forces (N° 24.948 - 1998/04/08)</li> <li>- National Intelligence Act (N° 25.520 - 2001/12/06)</li> </ul>	<ul style="list-style-type: none"> <li>- Military Service Act (N° 17.531 - 1967/11/16)</li> <li>- Military Personnel Act (N° 19.101 - 1971/07/19)</li> <li>- Financial Aid Institute Act for Pension and Retirement Payments (N° 22.919 - 1983/09/26. Last amendment: Decree N° 860 - 2009/07/07)</li> <li>- Voluntary Military Service Act (N° 24.429 - 1995/01/10)</li> <li>- Act on the Entry of Foreign Troops and the Deployment of National Troops outsider the Country (N° 25.880 - 2004/04/23)</li> <li>- Act which derogates the Code of Military Justice, approves reforms to the Criminal Code and to the Criminal Code of Procedures of the Nation; it also approves instructions to civilians in war times and in other armed conflicts, as well as the Armed Forces Code of Discipline and the organization of the joint justice service of the Armed Forces (N° 26.394 - 2008/08/26)</li> </ul>
<b>Bolivia</b>	
<ul style="list-style-type: none"> <li>- Organic Law of the Armed Forces (N° 1.405 - 1992/12/30)</li> <li>- Organization of the Executive Power Act (N° 2.446 - 2003/03/19)</li> </ul>	<ul style="list-style-type: none"> <li>- Decree-Law on the Military Social Insurance Corporation (N° 11.901 - 1974/10/21. Last amendment: Law N° 1.732 - 1996/11/29)</li> <li>- Decree-Law of Organization of Military Justice (N° 13.321 - 1976/04/02)</li> <li>- Manual on the Use of Force in case of Internal Conflict (Supreme Decree N° 27.977 - 2005/01/14)</li> </ul>
<b>Brazil</b>	
<ul style="list-style-type: none"> <li>- Act which establishes the Deployment of Brazilian Troops Overseas (N° 2.953 - 1956/11/20)</li> <li>- Act which determines the Cases when Foreign Armed Forces can transit or remain temporarily in National Territory (Complementary Act N° 90 - 1997/10/02)</li> <li>- Act which institutes the Brazilian System of Intelligence, creates the Brazilian Agency of Intelligence - ABIN (N° 9.883 - 1999/12/09)</li> <li>- Act on the organization and operation of the National Defence Council (N° 8.183 - 1991/04/11. Last amendment: 2001/08/31)</li> <li>- Act on the Organization of the Presidency of the Republic and the Ministers (N° 10.683 - 2003/05/28. Last amendment: MP 499/10 - 2010/08/25)</li> <li>- Act which Rules over National Mobilization and creates the National System of Mobilization (N° 11.631 - 2007/12/28)</li> </ul>	<ul style="list-style-type: none"> <li>- Military Pension Act (N° 3.765 - 1960/05/04. Last amendment: Provisional Measure 2215-10 - 2001/08/31)</li> <li>- Military Service Act (N° 4.375 - 1964/09/03)</li> <li>- Military Penal Code (Decree-Law N° 1.001 - 1969/10/21. Last amendment: Act N° 9.764 - 1998/12/17)</li> <li>- Code of Military Penal Procedure (Decree-Law N° 1.002 - 1969/10/21. Last amendment: Act. N° 9.299 - 1996/08/07)</li> <li>- Act on the Statute of the Members of the Armed Forces (N° 6.880 - 1980/12/11)</li> <li>- Act on Education at the Air Force (N° 7.549 - 1986/12/11)</li> <li>- Act on rendering Alternative Service to Compulsory Military Service (N° 8.239 - 1991/10/07)</li> <li>- Act on the Organization of Military Justice (N° 8.457 - 1992/09/04. Last amendment: Act N° 10.445 - 2002/05/07)</li> <li>- Act on Education at the Army (N° 9.786 - 1999/02/08)</li> <li>- Act on Regulations for the Organization, Preparation and Use of the Armed Forces, to establish New Subsidiary Powers (Complementary Act N° 117 - 2004/09/02; modifies Complementary Act N° 97 - 1999/06/09)</li> <li>- Act on Education at the Navy (Act N° 11.279 - 2006/02/09)</li> <li>- Complementary Act on Defence (Complementary Act N° 136 - 2010/08/25; modifies Complementary Act N° 97 - 1999/06/09)</li> </ul>
<b>Chile</b>	
<ul style="list-style-type: none"> <li>- Act which creates the Superior Council of National Defence (N° 7.144 - 1942/01/05. Last amendment: 1959/04/06)</li> <li>- Act which dictates Regulations on Mobilization (N° 18.953 - 1990/03/09)</li> <li>- Act on the National Intelligence System; creates the National Intelligence Agency (N° 19.974 - 2004/10/02)</li> <li>- Ministry of National Defence Organization Statute (N° 20.424 - 2010/02/04)</li> </ul>	<ul style="list-style-type: none"> <li>- Code of Military Justice (Decree-Law N° 806 - 1925/12/23. Last amendment: Act N° 20.357 - 2009/07/18)</li> <li>- Reserved Copper Law (N° 13.196 - 1958/01/01)</li> <li>- Act authorizing the President of the Republic the disposition of State-owned Lands and Real Estate used by the Armed Forces (N° 17.174 - 1969/08/21. Last amendment: DL N° 1.195 - 1975/11/01)</li> <li>- Act on out Rules for the Execution of Works designated for exclusive Military Use (N° 17.502 - 1971/11/12)</li> <li>- Decree-Law on the Recruiting and Mobilization of the Armed Forces (N° 2.306 - 1978/09/12. Last amendment: Law N° 20.045 - 2005/03/10)</li> <li>- Decree Law of the Military Public Ministry (N° 3.425 - 1980/06/14)</li> <li>- Decree which establishes Regulations on the Constitution, Mission, Dependency and Responsibilities of the Armed Forces (DS N° 272 - 1985/03/16)</li> <li>- Act on National Defence Staff Pension System (N° 18.458 - 1985/11/11. Last amendment: Act N° 20.369 - 2009/09/17)</li> <li>- Act for Armed Forces' Social Welfare Service Statute (N° 18.712 - 1988/06/04)</li> <li>- Act establishing the Authority of the Army Military Industry and Engineering Command (N° 18.723 - 1988/07/12)</li> <li>- Constitutional Organic Act of the Armed Forces (N° 18.948 - 1990/02/27. Last amendment: Act N° 20.424 - 2010/02/04)</li> <li>- Act of the Armed Forces health system (N° 19.465 - 1996/08/02)</li> <li>- Decree with Force of Law which establishes Armed Forces staff's statute (DFL N° 1 - 1997/10/27. Last amendment: DFL N° 1 - 2009/05/12)</li> <li>- Act which modernizes the Mandatory Military Service (N° 20.045 - 2005/09/10)</li> <li>- Act on Staff and Professional Troops for the Armed Forces (N° 20.303 - 2008/12/04)</li> <li>- Act which amends Act N° 19.067 and sets out Rules for Chilean troops to take part in Peace Operations (N° 20.297 - 2008/12/13)</li> <li>- Act of War Crimes and Crimes against Humanity (N° 20.357 - 2009/07/18)</li> </ul>
<b>Colombia</b>	
<ul style="list-style-type: none"> <li>- Decree by which the National Security Council merges with the Superior Council of National Defence and the Commission created by the Decree 813 of 1983 (N° 2.134 - 1992/12/31)</li> <li>- Act establishing Civil Service Career Rules (N° 443 - 1998/06/11)</li> <li>- Act by which benefits are granted to relatives of People Demised during Mandatory Military Service (N° 447 - 1998/07/21)</li> <li>- Act on National Agency Organization and Operation Rules (N° 489 - 1998/12/29)</li> <li>- Act by which the President of the Republic is vested with Extraordinary Authority to issue Rules related to Military Forces and the National Police (N° 578 - 2000/03/15)</li> <li>- Decree by which the Ministry of National Defence Structure is modified and other Provisions are enacted (N° 1.512 - 2000/08/11, Last amendment: Decree N° 4.881 - 2008/11/27)</li> <li>- Decree modifying the Bylaw which regulates the National Ministry of Defence</li> </ul>	<ul style="list-style-type: none"> <li>- Act on Recruiting and Mobilization Service (N° 48 - 1993/03/03)</li> <li>- Military Penal Code Act (N° 522 - 1999/08/12)</li> <li>- Decree which modifies the Decree which regulates the Rules for the Promotion of Officers and Warrant Officers of the Military Forces (N° 1.790 - 2000/09/14. Last amendment: Act N° 1.405 - 2010/07/28)</li> <li>- Act regulating Issues concerning Disability, Compensations, Disability Pensions and Administrative Reports for Injuries (N° 1.796 - 2000/09/14)</li> <li>- Act on the Unique Disciplinary Code (N° 734 - 2002/02/05)</li> <li>- Act which partially modifies the Statute of Promotions of Officers and Warrant Officers of the Military Forces (N° 775 - 2002/12/09)</li> <li>- Act which Rules over the Armed Forces Disciplinary Regime (N° 836 - 2003/07/16)</li> <li>- Decree establishing a Disability and Survival Pension System for Armed Forces Professional Soldiers (N° 2.192 - 2004/07/08)</li> </ul>



Colombia	Systems and Concepts	Military Organization
	<ul style="list-style-type: none"> <li>Civil Personnel Management System (N° 1.792 - 2000/09/14)</li> <li>- Act by which the Juridical Nature of Nueva Granada Military University is modified (N° 805 - 2003/04/29)</li> <li>- Act by which Provisions are established to reinstate Members of Outlaw Armed Groups (N° 975 - 2005/07/25)</li> <li>- General Act on Forestry (N° 1.021 - 2006/04/20)</li> <li>- Act which establishes the Special Administrative System for Civilian Public Employees at the Service of the National Ministry of Defence, for the Military Forces, the National Police and its Decentralised Entities (N° 1.033 - 2006/07/19)</li> <li>- Act governing the Acquisition of Goods and Services for National Security and Defence (N° 1.089 - 2006/09/01)</li> <li>- Decree governing Special Career System (N° 091 - 2007/01/17)</li> <li>- Decree setting out and modifying the Denomination and Classification of Jobs at Defence Agencies (N° 092 - 2007/01/17)</li> <li>- Decree setting out Basic Wage Scales for Civilian Staff (N° 093 - 2007/01/17)</li> <li>- Act 1.097 on Confidential Expenses Regulation Decree (N° 1.837 - 2007/05/25)</li> <li>- Act by which Rules are enacted to strengthen the Legal Frame which allows Intelligence and Counter intelligence Agencies to fulfill their Constitutional and Legal Mission (N° 1.288 - 2009/03/05)</li> </ul>	<ul style="list-style-type: none"> <li>- Act on Rules, Objectives and Criteria to set out the Pension System and Retirement Allowance for Members of the Public Force (N° 923 - 2004/12/30)</li> <li>- Act of Military Situation of People older than 28 (N° 924 - 2004/12/30)</li> <li>- Act on Requirements for Positions at Military Penal Jurisdiction (N° 940 - 2005/01/05)</li> <li>- Act which modifies Decrees related with the Wage System and Benefits (N° 987 - 2005/09/09)</li> <li>- Act which establishes a Special Procedure in the Penal Military Code (N° 1.058 - 2006/07/26)</li> <li>- Decree compiling the Rules of Decree Law 1.790 of 2000 on Career Rules (N° 1.428 - 2007/04/27)</li> </ul>
	Cuba	
	<ul style="list-style-type: none"> <li>- Decree Law on the Organization of the State's Central Administration (DL N° 67 - 1983/04/19. Last amendment: DL N° 147 - 1994/04/21)</li> <li>- National Defence Act (N° 75 - 1994/12/21)</li> </ul>	<ul style="list-style-type: none"> <li>- Military Penal Procedure Act (N° 6 - 1977/08/08)</li> <li>- Military Crime Act (N° 22 - 1979/02/15)</li> <li>- Decree Law on Social Security for Expatriates performing Civil or Military Missions (N° 90 - 1985/12/02)</li> <li>- Decree Law of Social Security for the Revolutionary Armed Forces (N° 101 - 1988/02/24. Last amendment: DL N° 222 - 2001/08/14)</li> <li>- Act of Military Courts (N° 97 - 2002/12/21)</li> <li>- Act of Military Prosecution (N° 101 - 2006/06/10)</li> </ul>
	Dominican Republic	
	<ul style="list-style-type: none"> <li>- Organic Act of the Armed Forces (N° 873 - 1978/08/08)</li> </ul>	<ul style="list-style-type: none"> <li>- Code of Justice of the Armed Forces (Act N° 3.483 - 1953/02/13)</li> </ul>
	Ecuador	
	<ul style="list-style-type: none"> <li>- Organic Act for National Defence (N° 74 - 2007/01/19. Last amendment: Act N° 35 - 2009/09/28)</li> <li>- Act of Public and State Security (N° 35 - 2009/09/28)</li> </ul>	<ul style="list-style-type: none"> <li>- Penal Military Code (Codification N° 27 - 1961/11/06)</li> <li>- Code of Penal Military Procedures (Codification N° 28 - 1961/11/06)</li> <li>- Act of Armed Forces Personnel (1991/04/10. Last amendment: 2009/06/08)</li> <li>- Social Security Act for the Armed Forces (N° 169 - 1992/08/07. Last amendment: 2009/03/30)</li> </ul>
	El Salvador	
	<ul style="list-style-type: none"> <li>- Organic Law of the Armed Force of El Salvador (DL N° 353 - 1998/07/30)</li> <li>- Act on the Intelligence Agency of the State (DL N° 554 - 2001/09/21)</li> <li>- National Defence Act (DL N° 948 - 2002/10/03)</li> </ul>	<ul style="list-style-type: none"> <li>- Military Justice Code (DL N° 562 - 1964/05/29. Last amendment: DL N° 368 - 1992/11/27)</li> <li>- Act of Military Decorations (DL N° 520 - 1969/10/24)</li> <li>- Act of the Armed Forces Social Security Institute (DL N° 500 - 1980/11/28. Last amendment: DL N° 1.027 - 2002/11/20)</li> <li>- Act on Military Career (DL N° 476 - 1995/10/18. Last amendment: DL N° 882 - 2005/11/30)</li> <li>- Act on Fire Arms, Ammunitions, Explosives and similar Articles Control and Regulation (DL N° 665 - 1999/07/26. Last amendment: DL N° 118 - 2009/10/09)</li> <li>- Act on Military Service and Reserves of the Armed Force (DL N° 298 - 2002/07/30. Last amendment: DL N° 793 - 2009/01/14)</li> </ul>
	Guatemala	
	<ul style="list-style-type: none"> <li>- Constitutive Act of the Guatemalan Army (DL N° 72-90 - 1990/12/13)</li> <li>- Executive Body Act (DL N° 114-97 - 1997/11/13)</li> <li>- General Bureau of Civil Intelligence Act (DL N° 71-2005 - 2005/10/12)</li> <li>- Framework Act on the National Security System (DL N° 18-2008 - 2008/04/15)</li> </ul>	<ul style="list-style-type: none"> <li>- Military Code (Decree N° 214 - 1878/09/15. Last amendment: Decree N° 41-96 - 1996/07/10)</li> <li>- Military Social Security Institute Organization Act (Decree Law N° 75-1984 - 1984/07/20. Last amendment: Decree N° 21-2003 - 2003/06/11)</li> <li>- Act on the Support to Civil Security Forces (Decree N° 40-2000 - 2000/06/16)</li> <li>- Civil Service Act (Decree N° 20-2003 - 2003/05/12)</li> <li>- Act on Fire Arms (Decree N° 15 - 2009 - 2009/04/21)</li> </ul>
	Honduras	
	<ul style="list-style-type: none"> <li>- Constitutive Act of the Armed Forces (Decree N° 39-2001 - 2001/10/29)</li> </ul>	<ul style="list-style-type: none"> <li>- Military Code (Decree N° 76 - 1906/03/01. Last amendment: Decree N° 47 - 1937/01/22)</li> <li>- Military Service Act (Decree N° 98-85 - 1985/08/22)</li> <li>- Personnel Act for the Members of the Armed Forces (Decree N° 231-2005 - 2005/10/11)</li> <li>- Military Security Service Institute Act (Decree N° 167 - 2006/11/27)</li> </ul>
	Mexico	
	<ul style="list-style-type: none"> <li>- Act to preserve the country's neutrality (DOF 1939/11/10)</li> <li>- Organic Law for Federal Public Administration (DOF 1976/12/29. Last amendment: DOF 2009/06/17)</li> <li>- National Security Act (DOF 2005/01/31. Last amendment: DOF 2005/12/26)</li> <li>- General Act on the Public Security System (DOF 2009/01/02)</li> </ul>	<ul style="list-style-type: none"> <li>- Navy General Ordinance (DOF 1912/01/08)</li> <li>- Discipline Act of the Mexican Army and Air Force (DOF 1926/03/15. Last amendment: DOF 2004/12/10)</li> <li>- Organic Act of Military Courts (DOF 1929/06/22. Last amendment: DOF 1931/02/24)</li> <li>- Code of Military Justice (DNL N° 005 - 1933/08/31. Last amendment: DOF 2005/06/29)</li> <li>- Military Service Act (DOF 1940/09/11. Last amendment: DOF 1998/01/23)</li> <li>- Act which creates the Army and the Air Force University (DOF 1975/12/29)</li> <li>- Reward Act for Navy of Mexico (DOF 1985/01/14)</li> </ul>

México	Systems and Concepts	Military Organization
		<ul style="list-style-type: none"> <li>- Organic Law of the Army, Air Force and Navy National Bank (DOF 1986/01/13. Last amendment: DOF 2002/06/24)</li> <li>- Organic Law of the Mexican Army and Air Force (DOF 1986/12/26. Last amendment: DOF 2009/06/12)</li> <li>- Discipline Act for the Personnel of the Navy of Mexico (DOF 2002/12/13)</li> <li>- Organic Act of the Navy of Mexico (DOF 2002/12/30. Last amendment: DOF 2009/06/12)</li> <li>- Act on Promotions and Rewards of the Mexican Army and Air Force (DOF 2003/10/30. Last amendment: DOF 2009/06/12)</li> <li>- Act for the Armed Forces Social Security Institute (DOF 2003/07/09. Last amendment: DOF 2008/11/20)</li> <li>- Act on Firearms and Explosives (DOF 1972/01/25. Last amendment: DOF 2004/01/23)</li> <li>- Act for checking, adjusting and calculating the Services for the Mexican Navy (DOF 2004/06/14. Last amendment: DOF 2009/06/12)</li> <li>- Promotions Act for the Navy of Mexico (DOF 2004/06/25. Last : DOF 2010/08/27)</li> <li>- Military Education Act for the Mexican Army and Air Force (DOF 2005/12/23)</li> <li>- Act for checking, adjusting and calculating the Services in the Mexican Army and Air Force (DOF 2006/02/09. Last amendment: DOF 2009/06/12)</li> </ul>
	Nicaragua	
	<ul style="list-style-type: none"> <li>- Act on the Organization, Competence and Procedures of the Executive Power (Nº 290 - 1998/06/03. Last amendment: Act Nº 612 - 2007/01/29)</li> </ul>	<ul style="list-style-type: none"> <li>- Code of Organization, Jurisdiction and Military Social Benefits (Act Nº 181 - 1994/08/23)</li> <li>- Organic Act of Military Tribunals (Nº 523 - 2005/04/05. Last amendment: Law Nº 567 - 2005/11/25)</li> <li>- Military Penal Code (Act Nº 566 - 2006/01/05)</li> <li>- Code of Military Penal Procedures (Act Nº 617 - 2007/08/29)</li> </ul>
	Paraguay	
	<ul style="list-style-type: none"> <li>- National Defence and Internal Security Act (Nº 1.337 - 1999/04/14)</li> <li>- Act which establishes the Border Security Zone (Nº 2.532 - 2005/02/17)</li> </ul>	<ul style="list-style-type: none"> <li>- Obligatory Military Service Act (Nº 569 - 1975/12/24. Last amendment: Law Nº 3.360 - 2007/11/02)</li> <li>- Organic Act of Military Courts (Nº 840 - 1980/12/19)</li> <li>- Military Penal Code (Act Nº 843 - 1980/12/19)</li> <li>- Code of Military Penal Procedures in War and Peace Times (Act Nº 844 - 1980/12/19)</li> <li>- General Organization of the National Armed Forces Act (Nº 74 - 1991/11/20. Last amendment: Act Nº 216 - 1993/06/16)</li> <li>- Act of the Military Personnel Statute (Nº 1.115 - 1997/08/27. Last amendment: Law Nº 2.879 - 2006/04/06)</li> <li>- Firearms, Ammunition and Explosives Act (Nº 1.910 - 2002/06/19)</li> <li>- Act on the Right to Conscientious Objection (Nº 4.013 - 2010/06/17)</li> </ul>
	Peru *	
	<ul style="list-style-type: none"> <li>- Act which establishes Rules for Exceptional Conditions in which the Armed Forces take over the Control of Internal Order (Nº 24.150 - 1985/06/07. Last amendment: DL Nº 749 - 1991/11/08) <sup>1</sup></li> <li>- Legislative Decree which establishes Rules which the Armed Forces have to be subjected to when operating in Zones not declared in State of Emergency (DL Nº 738 - 1992/03/10. Last amendment: Act Nº 28.222 - 2004/05/17)</li> <li>- Act on the Entry of Foreign Troops (Nº 27.856 - 2002/10/30)</li> <li>- National Mobilization Act (Nº 28.101 - 2003/11/13)</li> <li>- Security System and National Defence Act (Nº 28.478 - 2005/03/23)</li> <li>- National Intelligence System Act (Nº 28.664 - 2006/01/04)</li> <li>- Act which establishes the Legal Nature, Responsibilities, Competencies and Organic Structure of the Ministry of Defence (Nº 29.075 - 2007/08/01)</li> <li>- Act which establishes the Rules for the Use of Force by Members of the Military in the National Territory (Decree-Law Nº 1.095 - 2010/09/01)</li> </ul>	<ul style="list-style-type: none"> <li>- Peruvian Army Organic Act (DL Nº 437 - 1987/09/27. Last amendment: Act Nº 29.417 - 2009/09/30)</li> <li>- Peruvian Air Force Organic Act (DL Nº 439 - 1987/09/27)</li> <li>- Navy Organic Act (DL Nº 438 - 1987/09/27)</li> <li>- Organic Act for the Joint Command of the Armed Forces (DL Nº 440 - 1987/09/27)</li> <li>- Military Status Act for Officers of the Armed Forces (Nº 28.359 - 2004/10/13. Last amendment: Law Nº 29.406 - 2009/09/15)</li> <li>- Act which creates the Fund for the Armed Forces and the National Police (Nº 28.455 - 2004/12/31)</li> <li>- Military Police Penal Code (Decree-Law Nº 1.094 - 2010/09/01)</li> <li>- Act on the Promotion of Officers in the Armed Forces (Nº 29.108 - 2007/10/30. Last amendment: Act Nº 29.404 - 2009/09/10)</li> <li>- Act on the Disciplinary Regime of the Armed Forces (Nº 29.131 - 2007/11/09. Last amendment: DS 014-2009 -DE- 2009/05/23)</li> <li>- Police Justice Law Organization and Procedures Act (Nº 29.182 - 2008/01/11. Last amendment: Decree-Law Nº 1.096 - 2010/09/01)</li> <li>- Military Service Act (Nº 29.248 - 2008/06/28)</li> </ul>
	Uruguay	
	<ul style="list-style-type: none"> <li>- Act on State Security and Internal Order (Nº 14.068 - 1972/07/12)</li> <li>- Armed Forces Organic Act (DL Nº 14.157 - 1974/03/05. Last amendment: Act Nº 18.198 - 2007/11/28)</li> <li>- National Defence Framework Act (Nº 18.650 - 2010/03/08)</li> </ul>	<ul style="list-style-type: none"> <li>- Military Retirement Service Organization Act (Nº 3.739 - 1911/02/24. Last amendment: Act Nº 16.320 - 1992/11/01)</li> <li>- Military Codes (Decree-Law Nº 10.326 - 1943/01/28)</li> <li>- Organic Act of the Navy (Nº 10.808 - 1946/11/08)</li> <li>- Organic Act of the Air Force (Nº 14.747 - 1977/12/30)</li> <li>- Organic Act of the National Army (Nº 15.688 - 1985/01/17)</li> </ul>
	Venezuela	
	<ul style="list-style-type: none"> <li>- National Security Organic Act (GO Nº 37.594 - 2002/12/18)</li> </ul>	<ul style="list-style-type: none"> <li>- Organic Code of Military Justice (GO Nº 5.263 - 1998/09/17)</li> <li>- Organic Act of the Bolivarian National Armed Force (GO Nº 5.891 - 2008/07/31. Last amendment: GO Nº 5.933 - 2009/10/21)</li> <li>- Act of Military Service and Enrolment (GO Nº 5.933 - 2009/10/06)</li> </ul>

<sup>1</sup> The Constitutional Court declared as unconstitutional paragraphs c), d) and e) of article 5 amended by Legislative Decree Nº 749, and article 11; and it amended certain texts of articles 4, 5, 8 and 10 (sentence Nº 0017-2003-AI/TC - 2004/08/14).

\*The Legislative Decree concerning Self-Defence Committees as people's organizations to develop self-defence activities within their community (DL Nº 741 - 1991/08/11) was submitted for derogation by the Congress on July 1st 2010; said derogation is expected to occur by the end of this year.

**Source:** Compilation based on the above mentioned legislations. Acts falling in one category may also fall in others and do not exclusively belong to one.





**International Treaties**

Evolution of Latin American countries' endorsement to International Treaties

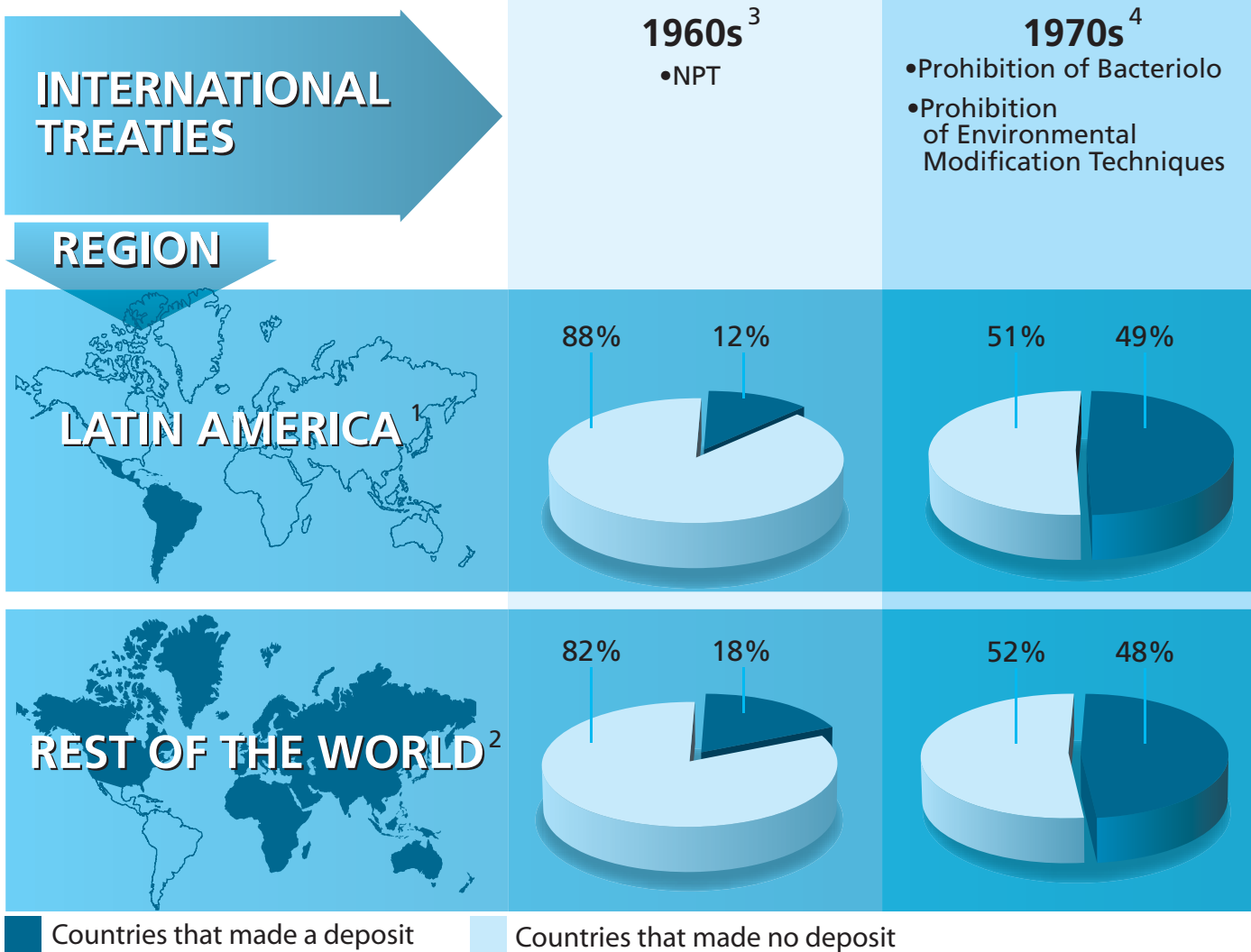

(1) Covers the seventeen countries included in the publication.  
 (2) All UN countries registered to date have been considered, except for those included in Latin America.  
 (3) The Treaty on the Non-Proliferation of Nuclear Weapons (NPT), opened for signature on July 1, 1968, has been taken into account.  
 (4) The prior treaty and the Convention on the Prohibition of the Development, Production and Stockpiling of Bacteriological (Biological) and Toxin Weapons

**Inter-American Treaties**

Evolution of Latin American Countries' endorsement to Inter-American Treaties

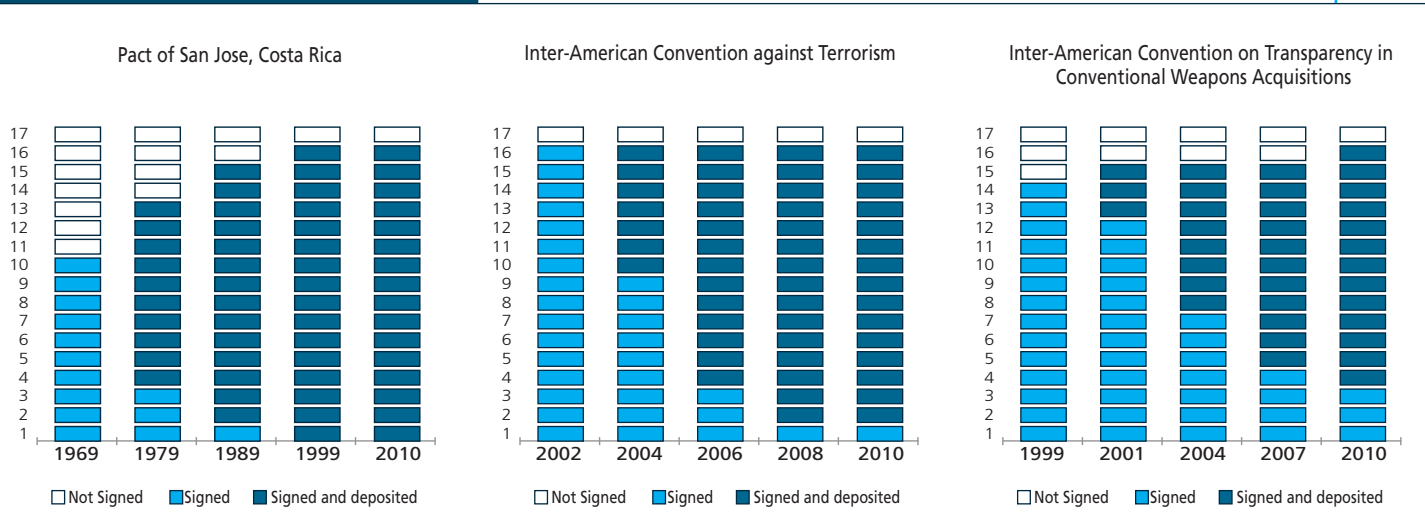

Source: Compilation based on the information supplied by the web site of the UN Disarmament Commission.

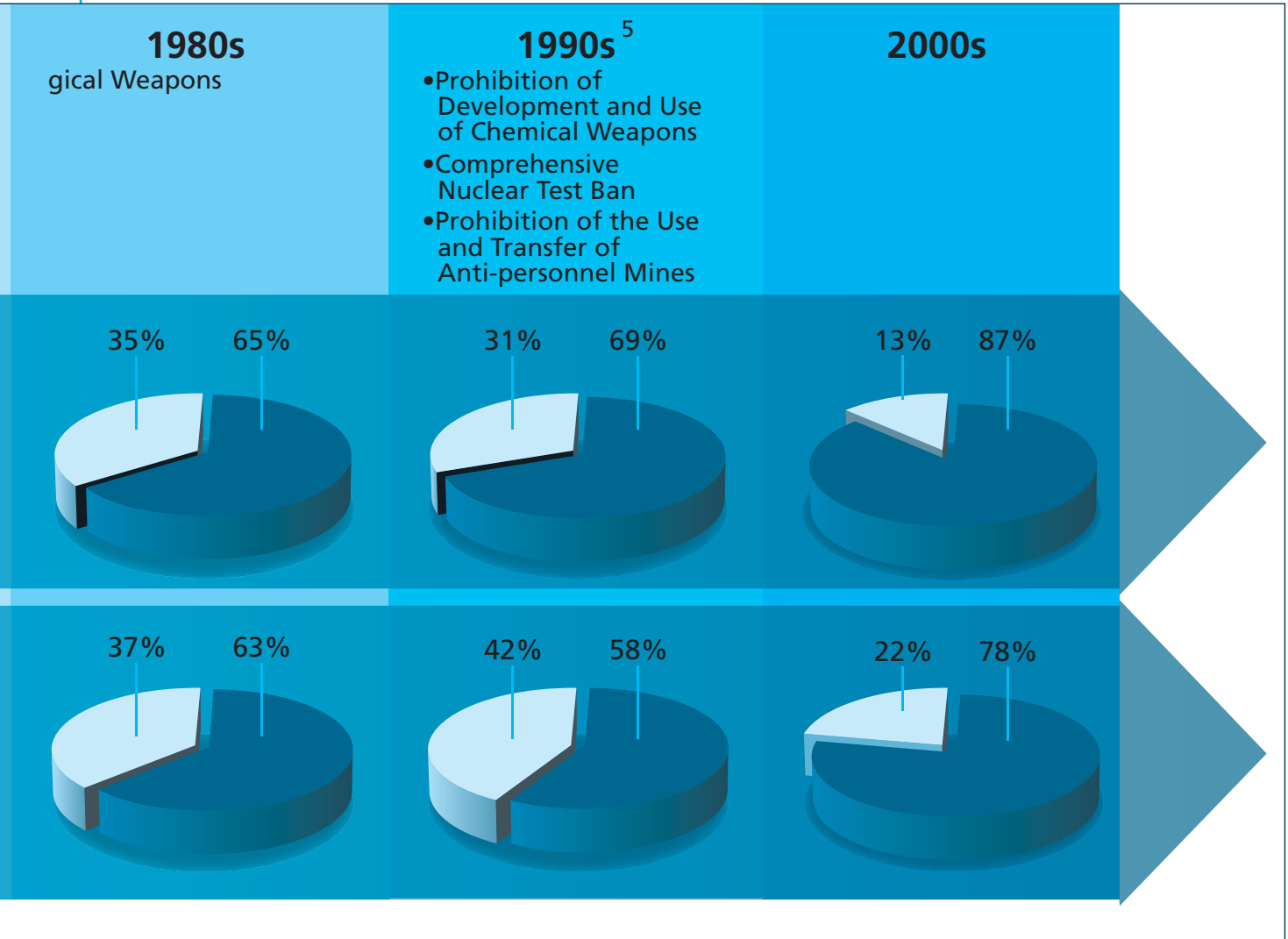

and on their Destruction, opened to signature on April 10, 1972, and the Convention on the Prohibition of Military or Any Other Hostile Use of Environmental Modification Techniques, opened to signature on May 18, 1977, have been taken into consideration.

(5) Prior treaties plus the Convention on the Prohibition of the Development, Production, Stockpiling and Use of Chemical Weapons and on Their Destruction, signed on January 13, 1993, the Comprehensive Nuclear Test Ban Treaty, opened to signature on September 24, 1996, and the Convention on the Prohibition of the Use, Stockpiling, Production and Transfer of Anti-Personnel Mines and on Their Destruction (Ottawa Convention), opened to signature on December 3 and 4, 1997, have been taken into consideration.

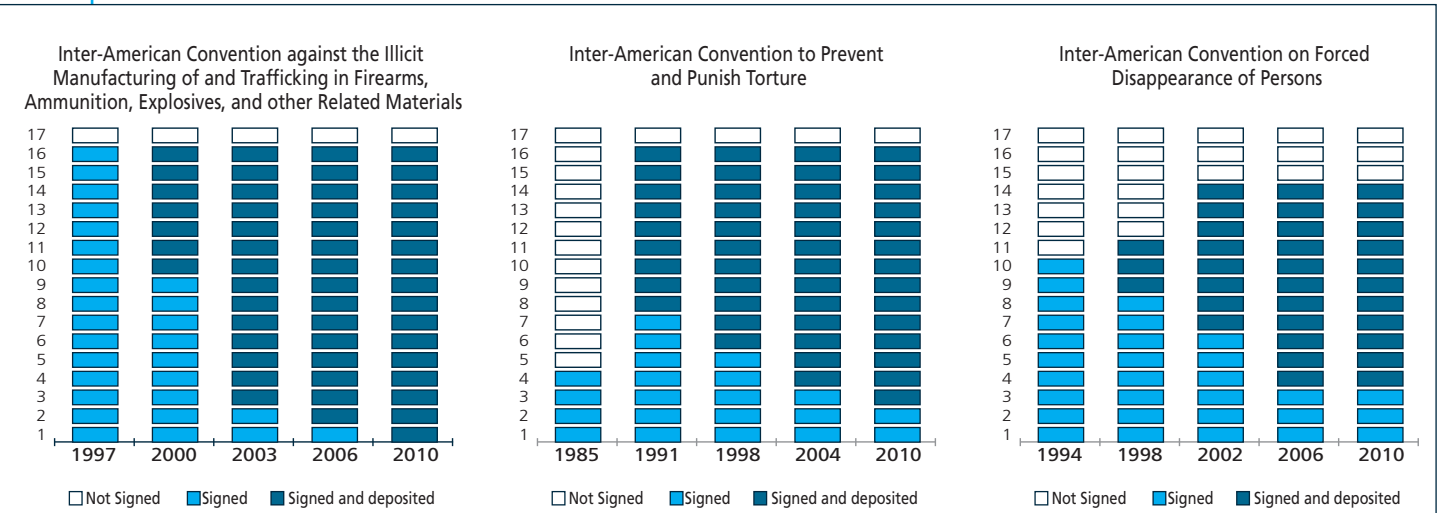

Source: Compilation based on the information supplied by the web page of the Department of International Law of the OAS.



### Military Criminal Justice Systems

#### Who is responsible for the trials?

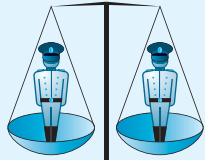

**MILITARY MODEL (MM)**

Courts are composed of members of the Armed Forces only

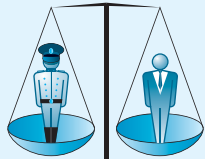

**MIXED MODEL (XM)**

Civilians participate in this system through Supreme Courts as the last resort of appeal

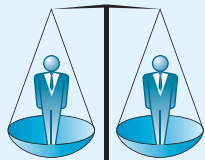

**CIVILIAN MODEL (CM)**

The courts in charge of trying military crimes are composed of civilians only. The military justice system is within the civil criminal system

#### Who is tried?



(m)

Members of the military



(mr)

Retired members of the military



(caf)

Civilian personnel of the Armed Forces



(cv)

Civilians not related to defence



(psf)

Police personnel and/or members of other security forces

Disciplinary sub system	Military Criminal Justice sub system
It punishes acts defined as a breach or infringement of military discipline.	It punishes acts defined as military crimes.
<b>Infringement of Disciplinary Rules</b>	<b>Military Crime</b>
Any willful or negligent act by military personnel affecting the disciplinary system.	An illegal act affecting any legally-institutionally protected interest, specific for and related to the military.

**Argentina:** Military jurisdiction was revoked by Law N°. 26.394, which establishes that all crimes committed by the military shall be tried by the ordinary justice

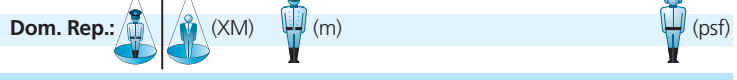
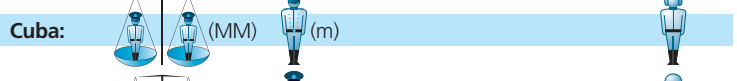
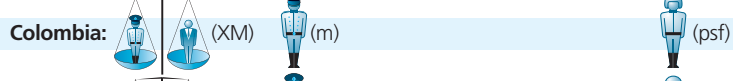

**Ecuador:** Military jurisdiction was modified by the Political Constitution of Ecuador Republic, which establishes that all crimes committed by the military shall be tried by the ordinary justice

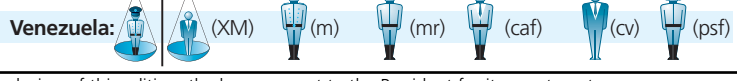
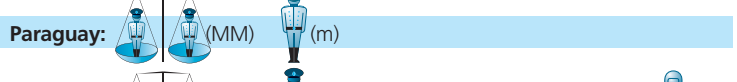
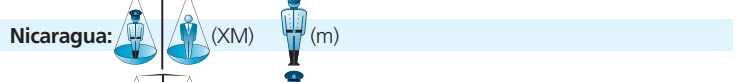
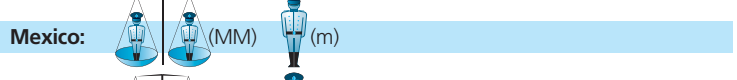
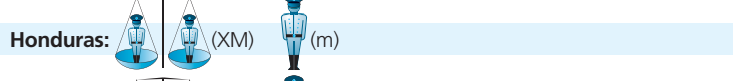
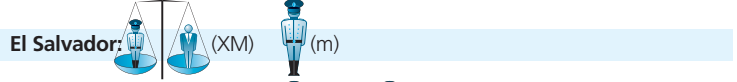

\*Note: A military justice code reform was passed by Congress. By the closing of this edition, the law was sent to the President for its enactment. The new rule establishes that civilians cannot be judged by the military justice.

**Source:** Compilation based on the following regulations: *Ley que deroga el Código de Justicia Militar, aprueba modificaciones al Código Penal y al Código Procesal Penal de la Nación, aprueba instrucciones para la población civil en tiempo de guerra y otros conflictos armados, el Código de Disciplina de las Fuerzas Armadas y la organización del servicio de justicia conjunto de las Fuerzas Armadas* (N° 26.394 – 2008/08/26) (Argentina). *Decreto Ley de organización judicial militar and Código Penal Militar* (Decree-Law N° 13.321 – 1976/04/02) (Bolivia). *Código Penal Militar* (Decree-Law N° 1.001 – 1969/10/21. Last amendment: Law N° 9.764 – 1998/12/17), and *Ley de organización judicial militar* (N° 8.457 – 1992/09/04. Last amendment: Act N° 10.445 – 2002/05/07) (Brazil). *Código de justicia militar* (Decree-Law N° 806 – 1925/12/23. Last amendment: Act N° 20.357 – 2009/07/18) (Chile). *Ley por la cual se expide el Código penal militar* (Act N° 1.407 – 2010/08/17) (Colombia). *Ley procesal penal militar* (N° 6 – 1977/08/08) and *Ley de los delitos militares* (N° 22 – 1979/02/15) (Cuba). *Código de justicia de las Fuerzas Armadas* (Act N° 3.483 – 1953/02/13) (Dominican Republic). Political Constitution (Ecuador). *Código de justicia militar* (DL N° 562 – 1964/05/29. Last amendment : DL N° 368 – 1992/11/27) (El Salvador). *Código militar* (Decree N° 214 – 1878/09/15. Last amendment: Decree N° 41-96 – 1996/07/10) (Guatemala). *Código penal militar* (Decree N° 76 – 1906/03/01. Last amendment: Decree N° 47 – 1937/01/22) (Honduras). *Código de justicia militar* (DNL N°005 – 1933/08/31. Last amendment: DOF 2005/06/29) (Mexico). *Código penal militar* (Act N° 566 – 2006/01/05) (Nicaragua). *Código penal militar* (Act N° 843 – 1980/12/19) (Paraguay). *Código Penal Militar Policial* (Decree-Law N° 1.094 – 2010/09/01) (Peru). *Códigos Militares* (Decree-Law N° 10.326 – 1943/01/28) and *Ley marco de defensa nacional* (N° 18.650 – 2010/03/08) (Uruguay). *Código orgánico de justicia militar* (GO N° 5.263 – 17/09/1998) (Venezuela).

## Legal Instruments on Military Justice

Country	Disciplinary Sub-system	Military Criminal Justice Sub-system
Argentina	<i>Ley que deroga el Código de justicia militar, aprueba modificaciones al Código Penal y al Código Procesal Penal de la Nación, aprueba instrucciones para la población civil en tiempo de guerra y otros conflictos armados, el Código de Disciplina de las Fuerzas Armadas y la organización del servicio de justicia conjunto de las Fuerzas Armadas (N° 26.394 – 2008/08/06).</i>	-----
Bolivia	<i>Reglamento de faltas disciplinarias y sus castigos (Supreme Resolution N° 181.303 – 1979/03/01).</i>	<i>Ley de organización judicial militar, Código penal militar, Código de procedimiento penal militar (Decree-Law N° 13.321 – 1976/04/02).</i>
Brazil	<i>Regulamento disciplinar da Aeronáutica (Decree N° 76.322 – 1975/09/22).</i>	<i>Código Penal Militar (Decree-Law N° 1.001 – 1969/10/21. Last amendment: Law N° 9.764 – 1998/12/17).</i>
	<i>Regulamento disciplinar do Exército e dá outras providências (Decree N° 4.346 – 2002/08/26).</i>	<i>Código de proceso penal militar (Decree-Law N° 1.002 – 1969/10/21. Last amendment: Law N° 9.299 – 1996/08/07).</i>
	<i>Regulamento disciplinar para a Marinha e dá outras providências (Decree N° 88.545 – 1983/07/26).</i>	<i>Ley de organización judicial militar (N° 8.457 – 1992/09/04. Last amendment: Act N° 10.445 – 2002/05/07).</i>
Chile	<i>Reglamento de disciplina para las Fuerzas Armadas (DS N° 1.445 – 1951/12/14)</i>	<i>Código de justicia militar (Decree-Law N° 806 – 1925/12/23. Last amendment: Act N° 20.357 – 2009/07/18).</i>
	<i>Reglamento de disciplina de la Armada. (DS N° 1.232 – 1986/10/21).</i>	<i>Código orgánico de tribunales (Law N° 7.421 – 1943/07/09. Last amendment: AA-S/N – 2008/03/20).</i>
Colombia	<i>Ley por la cual se expide el reglamento del régimen disciplinario para las Fuerzas Militares (N° 836 – 2003/07/16).</i>	<i>Ley por la cual se expide el Código penal militar (Act N° 1.407 – 2010/08/17).</i>
Cuba	-----	<i>Ley procesal penal militar (N° 6 – 1977/08/08). Ley de los delitos militares (N° 22 – 1979/02/15). Ley de los tribunales militares (N° 97 – 2002/12/21).</i>
Dominican Republic	<i>Reglamento militar disciplinario de las Fuerzas Armadas (Decree N° 02-08).</i>	<i>Código de justicia de las Fuerzas Armadas (Act N° 3.483 – 1953/02/13).</i>
Ecuador	<i>Reglamento de disciplina militar (Acuerdo Ministerial N° 831 – 1998/08/07).</i>	<i>Código penal militar (Codification N° 27 – 1961/11/06). Código de procedimiento penal militar (Codification N° 28 – 1961/11/06).</i>
El Salvador	<i>Código de justicia militar (DL N° 562 – 1964/05/29. Last amendment: DL N° 368 – 1992/11/27).</i>	<i>Código procesal penal militar (DL N° 904 – 1996/12/04).</i>
Guatemala	<i>Reglamento de sanciones disciplinarias (Acuerdo Gubernativo N° 24-2005 – 2005/01/24).</i>	<i>Código militar (Decree N° 214 – 1878/09/15. Last amendment: Decree N° 41-96 – 1996/07/10).</i>
Honduras	<i>Reglamento de personal para los miembros de las fuerzas armadas (Law and Order Department 2005 – 1991/09/12).</i>	<i>Código penal militar (Decree N° 76 – 1906/03/01. Last amendment: Decree N° 47 – 1937/01/22).</i>
Mexico	<i>Ley de disciplina del Ejército y Fuerza Aérea (DOF 1926/03/15. Last amendment: DOF 2004/12/10).</i>	<i>Ley orgánica de los tribunales militares (DOF 1929/06/22. Last amendment: DOF 1931/02/24).</i>
	<i>Ley de disciplina para el personal de la Armada de México (DOF 2002/12/13).</i>	<i>Código de justicia militar (DNL N°005 – 1933/08/31. Last amendment: DOF 2005/06/29)</i>
Nicaragua	<i>Reglamento disciplinario militar (Order N° 17 – 2007/08/13).</i>	<i>Ley orgánica de tribunales militares (N° 523 – 2005/04/05. Last amendment: Law N° 567 – 2005/11/25).</i>
		<i>Código penal militar (Act N° 566 – 2006/01/05).</i>
		<i>Código de procedimiento penal militar (Act N° 617 – 2007/08/29).</i>
Paraguay	<i>Código penal militar (Act N° 843 – 1980/12/19).</i>	<i>Ley Orgánica de los tribunales militares (N° 840 – 1980/12/19).</i>
		<i>Código de procedimiento penal militar en tiempo de paz y de guerra (Act N° 844 – 1980/12/19).</i>
Peru	<i>Ley del régimen disciplinario de las Fuerzas Armadas (N° 29.131 – 2007/11/09. Last amendment: DS 014-2009-DE – 2009/05/23).</i>	<i>Código Penal Militar Policial (DL N° 1.094 – 2010/09/01). Ley de organización y funciones del fuero militar policial (N° 29.182 – 2008/01/11. Last amendment: DL N° 1.096 – 2010/09/01).</i>
Uruguay	<i>Reglamento general de disciplina para el personal militar de la Fuerza Aérea (Decree 55/994 – 1994/02/08).</i>	<i>Códigos militares: Código penal militar, Código de organización de los tribunales militares, Código de procedimiento penal militar (DL N° 10.326 – 1943/01/28).</i>
	<i>Reglamento de disciplina de la Armada Nacional (Decree 180/001 – 2001/05/17).</i>	
	<i>Reglamento general del servicio N° 21. Ejército Nacional (Decree 305/003 – 2003/07/29)</i>	
Venezuela	<i>Reglamento de castigos disciplinarios (N° 6 – 1949/01/31).</i>	<i>Código orgánico de justicia militar (GO N° 5.263 - 1998/09/17) Código orgánico procesal penal (GO N° 38.536 – 2006/10/04).</i>

Source: Compilation based on above-mentioned legislation.



## Analisis

# Military Constitutional Missions in Latin America

**David Pion-Berlin**

*Professor of Political Science – University of California, Riverside.*

■ Constitutions are powerful, legal instruments. They define rights, freedoms, obligations and roles that are of vital, national importance. And because that is so, they are difficult to revise. Where military missions are enshrined within constitutions they are not only elevated in stature, but likewise, difficult to amend or repeal. Thus, nations want to be sure that the roles that they constitutionally delegate to the armed forces are ones that should not or could not be reserved for civilians, are absolutely vital to national interests, and are carefully circumscribed. In a democracy, powers should never be too generously granted to any organization with enormous coercive might. That is particularly so in a region like Latin America, whose militaries for too long used their formidable power to pursue selfish ends, often at the expense of democratic regimes. Governments want militaries that are capable of executing missions *they* delegate, not ones that are delegated for them. But that does not necessarily mean it is wise to constitutionally delegate military missions. Much depends on the purpose and nature of the operation itself.

The most common constitutional permission pertains to the defense of “la patria.” No other security force has the ability to defend the nation against existential threats, and so these mission assignments are reasonable and necessary. Seventy five percent of Latin American states constitutionally authorize the armed forces to protect the independence, territorial integrity and sovereignty of the nation. They do not exclude the possibility that threats to the nation may arise from inside the nation itself. Indeed, all Latin American nations allow for some form of internal security role for the armed forces though these may not always appear in the constitution itself.

Argentina, Uruguay, Mexico, and Cuba make no con-

stitutional mention of any defensive role for the military. But in some cases, there are other laws that do so. For example, Argentina’s Defense Law (Ley Nº 23.554) states that the military is to be used to defend against external aggressors only, ones who threaten the sovereignty, territorial integrity or political independence of the country. Mexico’s Organic Law of the Army and Air Force stipulates that the military shall defend the integrity, independence and sovereignty of the nation; and Uruguay’s Military Organic Law (Decreto Ley Nº 14.757) has similar language.

Six of seventeen countries have constitutions that stipulate military powers to defend either constitutions, constitutional powers or constitutional orders. While at first blush this may seem unobjectionable we should not forget that in the past, militaries have justified the overthrow of regimes by purporting to be defenders of the constitution. In March, 1976, Argentine General Jorge Videla said “profoundly respectful of constitutional powers, the natural underpinning of democratic institutions, the armed forces, on repeated occasion sent clear warnings to the government about the dangers that existed and also about the shortcomings of their senseless acts.”<sup>1</sup> If the highest law of the land grants the military the power to be its guardian, can the military infer it may protect the Magna Carta against purported infractions committed by the President? The Congress? The Courts? If the armed forces believe such language affords them some power of discretion -to decide if and when the constitution have been violated by politicians- then they may also infer they have the power to intervene to overthrow those authorities. It is for these

<sup>1</sup> Brian Loveman and Thomas Davies Jr., eds., *The Politics of Anti-Politics: the Military in Latin America*, (Lincoln: University of Nebraska Press, 1989), 199-200.

reasons and no doubt others that ten nations choose not to define any military defense of the constitution at all.

Those legal “silences” allow other sections of the constitution to reign, restricting the military’s own interpretation. In particular, all constitutions in Latin America state that only the President as commander in chief can order the military to act; the military has no powers of self-direction. And all those constitutions that have language pertaining to the military mention that the military is a non-deliberative actor, meaning it is prohibited from convening on political matters or reaching independent political decisions, obviously including those that would plot the overthrow of the president, or other legitimate office holders. That leaves them without the legal means of initiating political praetorian actions against the president based on *their own* interpretation of the constitution and whether or not it has been violated. But what about the interpretation of others such as a Supreme Court? Some might ask whether the Honduran Supreme Court was within its right to instruct the military to oust the president based on his *alleged* constitutional violation. And were the armed forces obligated to comply, as they did on June 28, 2009? Legal and political scholars will no doubt debate this point for some time to come. While President Zelaya had the constitutional right to order the military to provide logistical assistance for the referendum, other portions of the Honduran constitution prohibit the military from obeying illegal orders.<sup>2</sup> Then whose judgment call is it? None of this obscures the fact that President Zelaya was the victim of a coup—one authorized, organized and implemented by a host of civilian and military actors. Sometimes, what is *not* stated in constitutions is as important as what is. For example, only six constitutions authorize the military to undertake public order functions. And yet, my own research indicates that all Latin American nations explicitly or implicitly allow their militaries to engage in internal security operations of one form or another, including the preservation of public order and security.<sup>3</sup> Even countries that impose the tightest restrictions (Argentina, Nicaragua) nonetheless have escape clauses that do not preclude the introduction of the military in rare circumstances.

For example, all constitutions allow for states of ex-

ception which authorize the President to take unusual measures (i.e. curbing civil liberties, making arrests without warrants, etc.) to restore internal order during grave crises by calling on an assortment of security forces. In only one or two cases does state of siege or emergency clauses specify that the military per se would be used; in all the other cases, it would be left to the discretion of the President. He could plausibly resort to police, military police, hybrid forces (Gendarmería, National Guard) the armed forces, or some combination of these. If an internal threat to public security were to overwhelm the police and other internal security forces, the head of state could, in theory, call upon the military to intervene as a last resort.

Constitutional states of exception “raise the bar” on military intervention. Those missions would be undertaken only on rare occasion, require substantial justification and presidential authorization, have built in time limitations (usually between 45-90 days) and be subject to congressional concurrence and re-authorization. The intent is to limit military operations to those occasions when maximum lethal force will be imperative to subdue internal threats. And it is especially in these instances when civilian control should be rigorously applied by the highest authorities.

These kind of constitutional provisions lend greater weight, clarity, and firmness to the president’s role, leaving less room for military interpretation or challenge. There are difficulties however. First, these measures are reserved only for grave national emergencies marked by pervasive violence. They are normally not invoked for lower threshold instability and certainly not for ordinary law enforcement purposes. Second, states of exception are affirmative, not prohibitive; they indicate when presidents may call upon their militaries rather than specify all those situations when they may not. Only a handful of countries restrict the military’s internal security use to *only* states of siege or emergency, leaving the door open to other uses. Hence the third problem is that too many countries sanction internal missions of all sorts through their organic military laws or national security laws without defining limits: thresholds, time duration, rules of engagement, or political authorizations.

Approximately three quarters of Latin American countries fail to draw the line between high and low threshold security functions; they allow armies to switch from national security to public security or public order functions such as anti-crime patrols, counter-narcotic ope-

2 J. Mark Ruhl, “Honduras Unravels”, *Journal of Democracy*, Volume 21, no 2, (2010): 93-107.

3 David Pion-Berlin, “Seguridad Militar y Misiones de Desarrollo en América Latina”, in *Perspectivas para la Democracia en América Latina*, ed. Leticia Heras Gómez and John A. Booth, 305-326, (Xochicalco: Universidad Autónoma del Estado de México, 2009).



rations or suppression of civilian uprisings. Without clear limitations and guidelines—including rules of engagement—that would set boundaries to military public security functions, there is the risk that ambiguity will lead to costly errors and excesses. According to a 2007 study by FLACSO, the following countries establish general internal security missions but do not specify actual functions: Bolivia, Colombia, Guatemala, Mexico and Peru.<sup>4</sup> My own research reveals the same for Paraguay, Uruguay and Venezuela. And finally, some forty percent of Latin American countries allow for military use for public security and law and order without explicitly stating that each mission assignment must be made by the president or a legitimate political official.

Latin American states must perform a delicate balancing act: to place constitutional restrictions on military use without completely tying the hands of political leaders who may need to rely on soldiers from time to time. Licensing public order/public security military functions at a constitutional level, and doing so without explicit limitations—as do Guatemala, Honduras and Venezuela—is ill advised. At the same time, restricting such use to only states of siege is simply impractical for countries like Mexico, Guatemala, Honduras and El Salvador which are confronted daily by highly capable and lethal criminal organizations. Presidents need discretion, but societies need protection from the potential misuse of military power. Thus it seems reasonable that either constitutions or more preferably, security laws be revised to allow for the circumstantial, last resort use of military power to assist police forces in subduing organized crime—but only with presidential authorization and congressional approval.

Nearly all Latin American militaries find themselves implicated in development missions, requiring that soldiers expand their reach beyond classic defense-related roles. Soldiers can be seen building infrastructure, hos-

pitals, schools, conducting literacy campaigns, protecting the environment, distributing goods, and providing medical services. These missions are somewhat controversial, and history is replete with cautions against undertaking them: the chance for mission creep, the development of entrenched military interests far a field from defense, and the distractions from defense-related training regimens. If the military represents the only organization capable of meeting those needs, so be it. As unfortunate as that may be, governments faced with huge development deficits may have little choice but to depend on soldiers. It does require however that governments remain vigilant against military efforts to exert permanent ownership over these assignments, so that civilian agencies could eventually fill those roles.

And that is the predicament with embedding such missions within constitutions, as do some 40 percent of Latin American countries—the bulk of which are among the region's poorest (i.e. Bolivia, Honduras, El Salvador, Ecuador). Once a development oriented mission is legitimized constitutionally, it is difficult to revoke. The military's role is elevated in stature by virtue of its constitutionality. The armed forces will exert guardianship over those missions, arguing that they and only they should be authorized to conduct those activities. It also becomes difficult if not impossible to impose time limitations on missions especially in light of the fact that underdevelopment is a deep-rooted, intractable, and persistent problem.

In sum, granting constitutional licenses to military action may be well advised for the defense of the nation against grave external threats. But for other challenges, having too many military constitutional prerogatives is unwarranted. Countries need to clarify if and when they should call upon the armed forces to assist in internal security and developmental missions. And clear restrictions and rules of engagement must be written. But they should be written within the defense and security laws of the land, not within the framework of constitutions.

<sup>4</sup> Facultad Latinoamericana de Ciencias Sociales (Chile), *Reporte del Sector Seguridad en América Latina y el Caribe*, (Santiago de Chile: FLACSO, 2007), 50.

Chapter 2:

# The Institutions

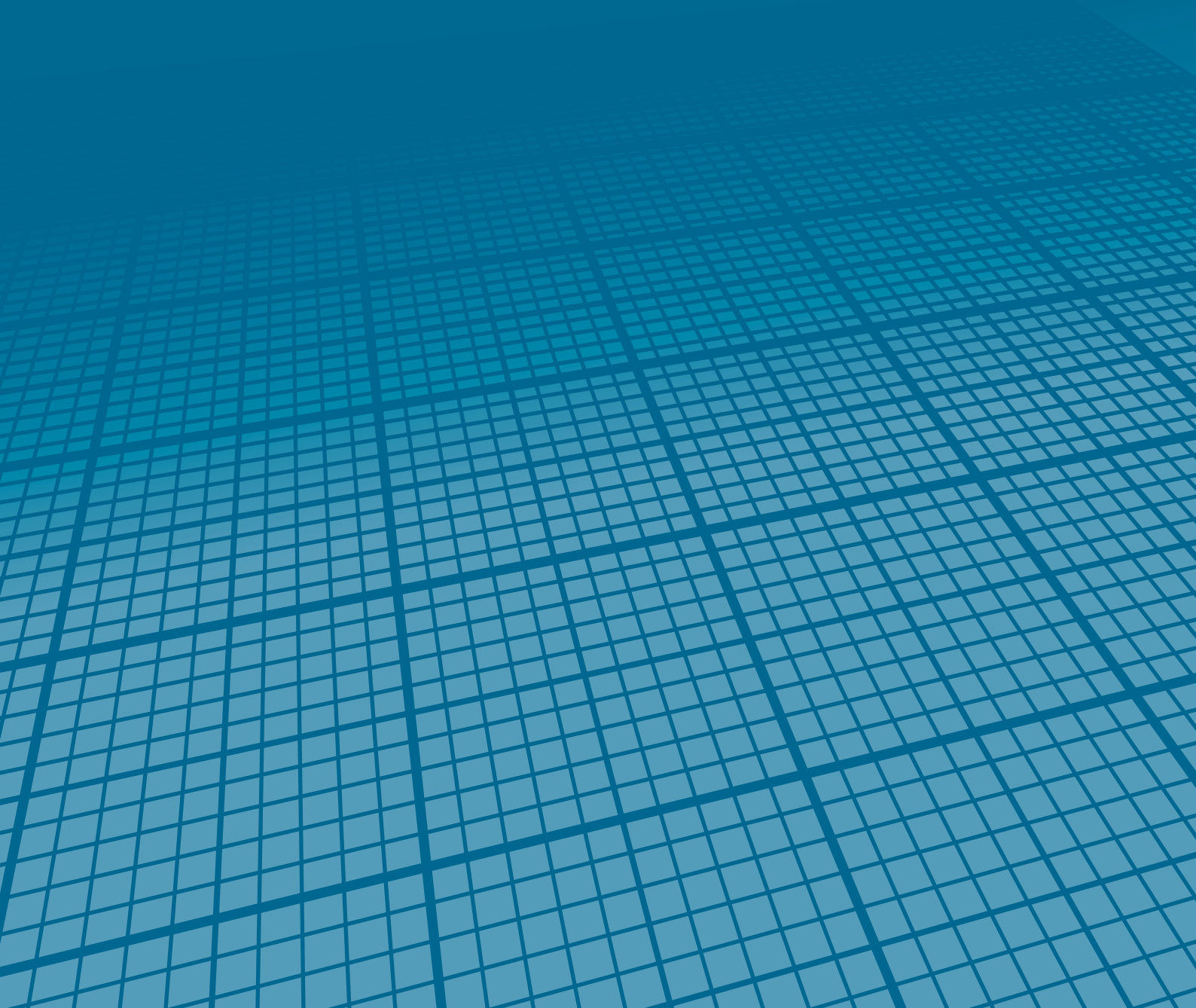





## Defence System Structure

### Defence system organization

Chain of command design, political leadership-military relations, security and defence councils, and role of the Joint Chiefs of Staff in the various institutional organizations.

- Advisory and assistance functional relationship
- Command reporting line
- Joint planning and management relationship

### ARGENTINA

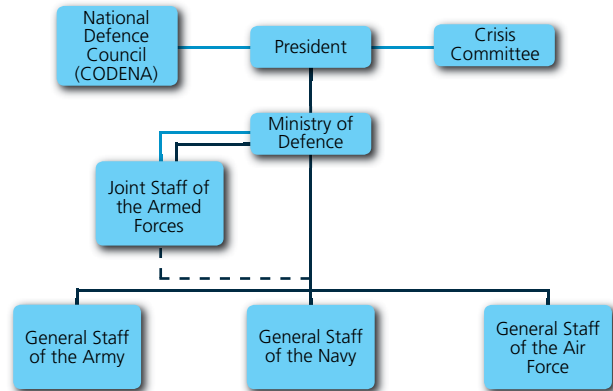

Source: Compilation based on *Ley de Defensa Nacional* (N° 23.554 - 05/05/1988) and *Reglamentación de la Ley de Defensa Nacional* (Decree N° 727/2006 - 2006/06/13).

### BOLIVIA

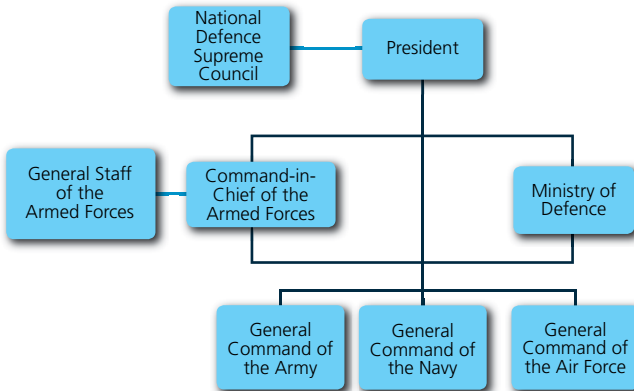

Source: Compilation based on *Ley Orgánica de las Fuerzas Armadas* (N° 1.405 - 1992/12/30).

### BRAZIL

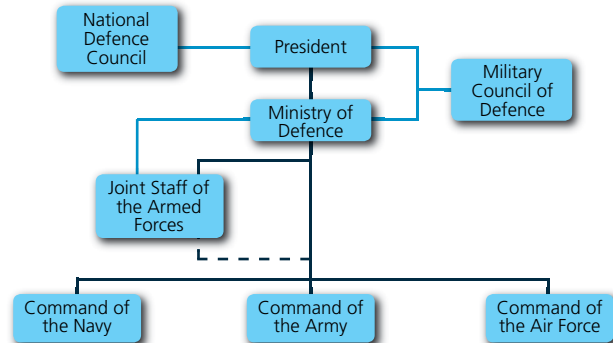

Source: Compilation based on the Political Constitution; *Lei que dispõe sobre a organização e o funcionamento do Conselho de Defesa Nacional e dá outras providências* (N° 8.183 - 1991/04/11. Last amendment: 2001/08/31); *Lei sobre as Normas Gerais para a Organização, o Preparo e o Emprego das Forças Armadas, para Estabelecer Novas Atribuições Subsidiárias* (Complementary Act N° 117 - 2004/09/02; modifies Complementary Act N° 97 - 1999/06/09); and *Lei Complementar da Defesa* (Complementary Act N° 136 - 2010/08/25; modifies Complementary Act N° 97 - 1999/06/09).

### CHILE

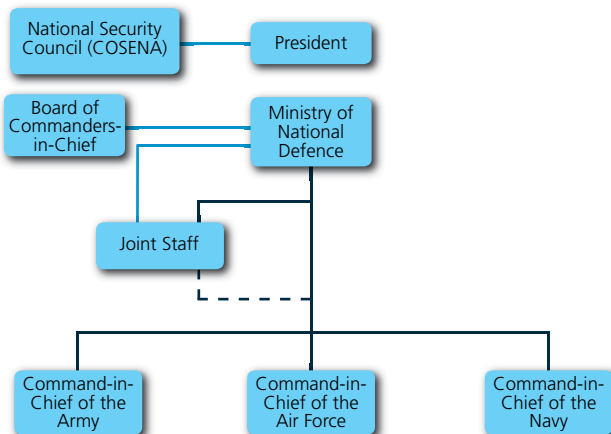

Source: Compilation based on the Political Constitution, *Ley del Estatuto Orgánico del Ministerio de Defensa Nacional* (N° 20.424 - 2010/02/04) and the *Libro de la Defensa Nacional* (2010).

### COLOMBIA

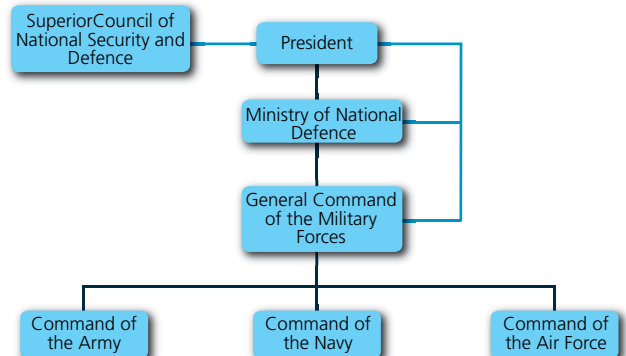

Source: Compilation based on *Decreto por el cual se modifica parcialmente la estructura del Ministerio de Defensa Nacional* (N° 1.512 - 200/08/11. Last amendment: Decree N° 4.481 - 2008/11/27), and *Decreto por el cual se fusionan el Consejo Nacional de Seguridad, el Consejo Superior de la Defensa Nacional y la Comisión creada por el Decreto 813 de 1983* (N° 2.134 - 1992/12/31).

**CUBA**

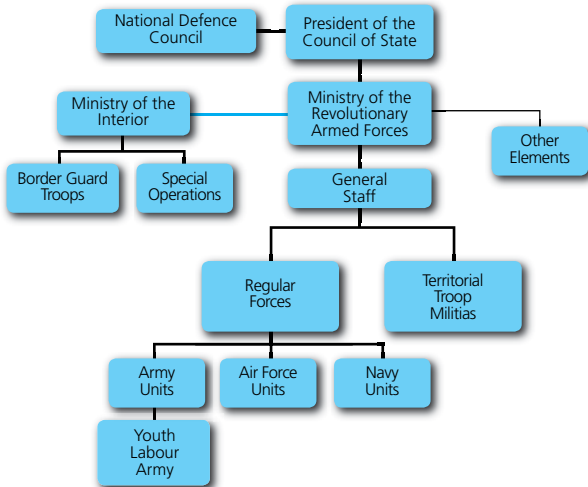

Source: Compilation based on *Ley de la defensa nacional* (N° 75 - 1994/12/21).

**DOMINICAN REPUBLIC**

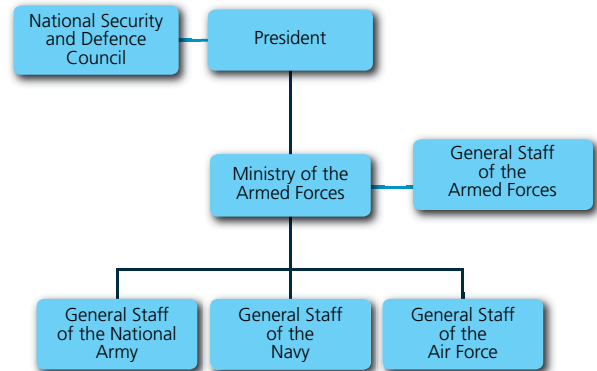

Source: Compilation based on the Political Constitution and the *Ley orgánica de las Fuerzas Armadas* (N° 873 - 1978/05/08).

**ECUADOR**

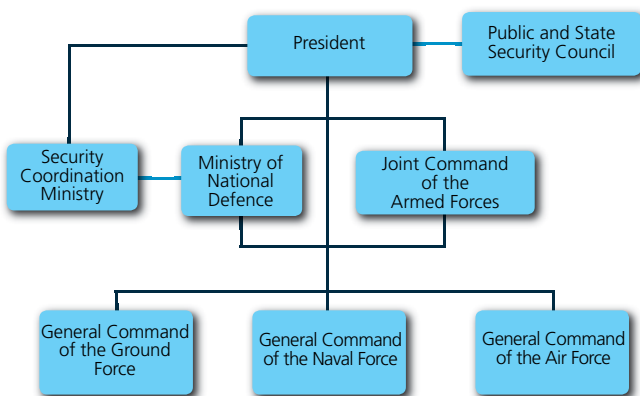

Source: Compilation based on *Ley orgánica de la defensa nacional* (N° 74 - 2007/01/19. Last amendment: Act N° 35 - 2009/09/28), and *Ley de seguridad pública y del Estado* (N° 35 - 2009/09/28).

**EL SALVADOR**

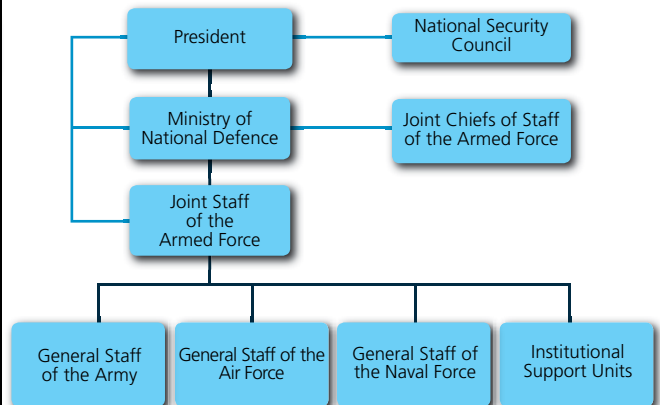

Source: Compilation based on the Political Constitution, *Ley orgánica de la Fuerza Armada de El Salvador* (DL N° 353 - 1998/07/30), and *Ley de la defensa nacional* (DL N° 948 - 2002/10/03).

**GUATEMALA**

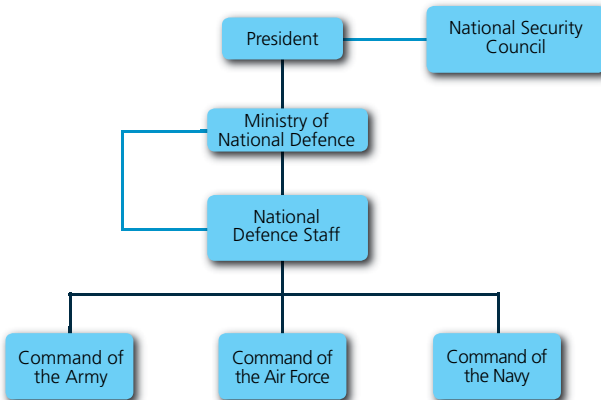

Source: Compilation based on *Ley marco del sistema nacional de seguridad* (DL N° 18-2008 - 2008/04/15) and *Ley constitutiva del Ejército de Guatemala* (DL N° 72-90 - 1990/12/13).

**HONDURAS**

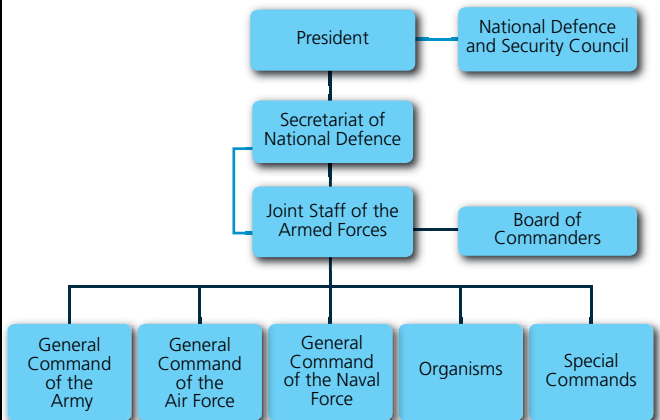

Source: Compilation based on the Political Constitution, *Ley constitutiva de las Fuerzas Armadas* (Decree N° 39-2001 - 2001/10/29) and *Libro Blanco de la Defensa Nacional* (2005).



**MEXICO**

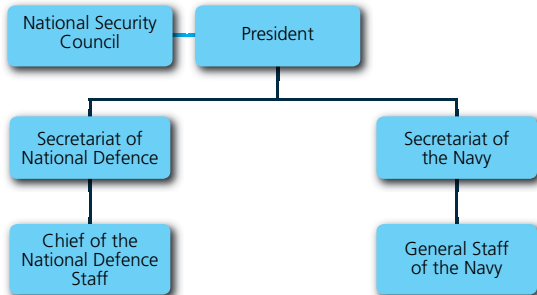

**Source:** Compilation based on the Political Constitution, *Ley orgánica de la administración pública federal* (DOF 1976/12/29. Last amendment: DOF 2009/06/17), *Ley orgánica de la Armada de México* (DOF 2002/12/30. Last amendment: DOF 2009/06/12), *Ley orgánica del Ejército y la Fuerza Aérea* (DOF 1986/12/26. Last amendment: DOF 2009/06/12), and *Ley de seguridad nacional* (DOF 2005/01/31. Last amendment: DOF 2005/12/26).

**NICARAGUA**

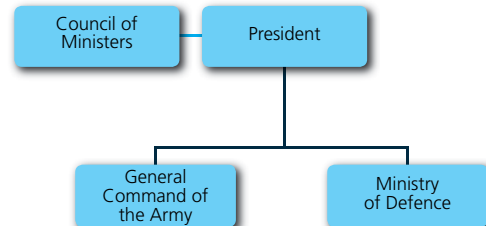

**Source:** Compilation based on *Ley de organización, competencia y procedimientos del Poder Ejecutivo* (N° 290 - 1998/06/03. Last amendment: Act N° 612 - 2007/01/29).

**PARAGUAY**

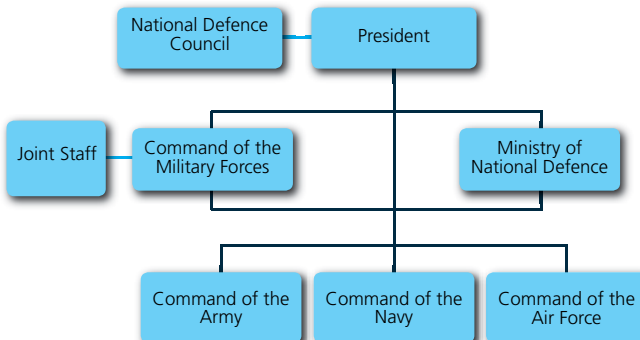

**Source:** Compilation based on the Political Constitution, *Ley de defensa nacional y de seguridad interna* (N° 1.337 - 1999/04/14), and *Ley de organización general de las Fuerzas Armadas de la Nación* (N° 74 - 1991/11/20. Last amendment: Act N° 216 - 1993/06/16).

**PERU**

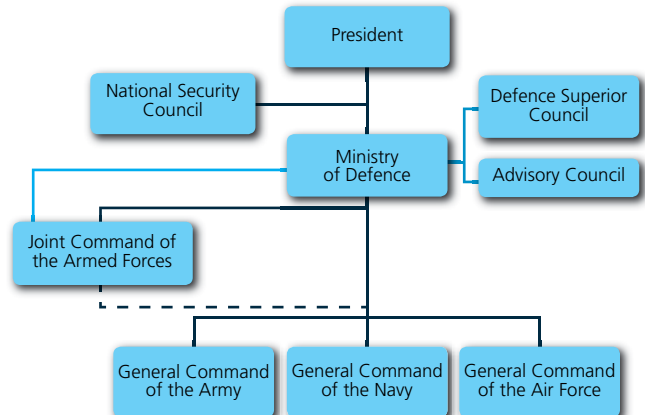

**Source:** Compilation based on *Ley que establece la naturaleza jurídica, función, competencias y estructura orgánica básica del Ministerio de Defensa* (N° 29.075 - 2007/08/01) and *Ley del sistema de seguridad y defensa nacional* (N° 28.478 - 2005/03/23).

**URUGUAY**

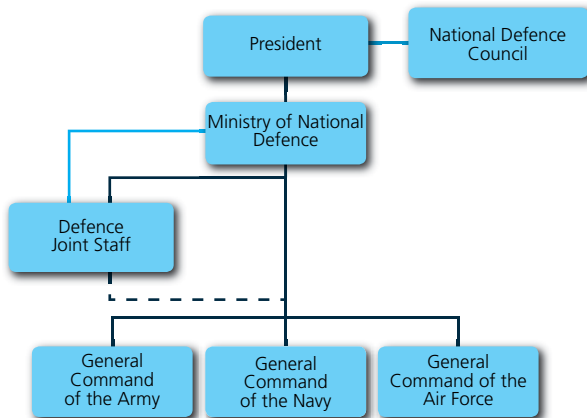

**Source:** Compilation based on the Political Constitution, *Ley orgánica de las Fuerzas Armadas* (N° 14.157 - 1974/03/05. Last amendment: Act N° 15.808 - 1986/04/07), and *Ley marco de defensa nacional* (N° 18.650 - 2010/03/08).

**VENEZUELA**

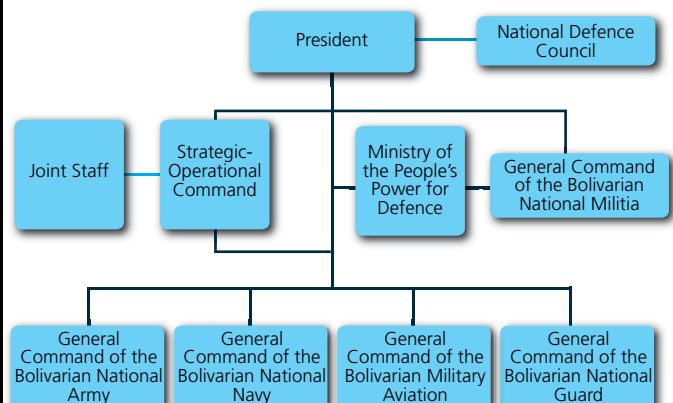

**Source:** Compilation based on the Political Constitution, *Ley orgánica de seguridad de la Nación* (GO N° 37.594 - 2002/12/18), and *Ley orgánica de la Fuerza Armada Nacional Bolivariana* (GO N° 6.239 - 2009/08/13. Last amendment: Act N° 6.239 - 2009/10/21).

## Responsibilities of the Ministries of Defence

Country	Responsibility
<b>Argentina</b> Ministry of Defence	The Ministry of Defence exercises the direction, organization and coordination of the activities that are proper to national defence and are not exclusively or directly conducted by the President or assigned to other officials, bodies or organizations. ( <i>Ley de Defensa Nacional</i> , Nº 23.554 – 1988/05/05, Sec. 11).
<b>Bolivia</b> Ministry of Defence	The Ministry of Defence is the political and administrative body of the Armed Forces. The Minister of Defence is the legal representative of the armed institution before the public powers. ( <i>Ley orgánica de las Fuerzas Armadas</i> , Nº 1.405 – 1992/12/30, Sec. 22).
<b>Brazil</b> Ministry of Defence	The Minister of Defence exercises the senior leadership of the Armed Forces, on the advice of the Military Council of Defence as the permanent consultation body, the Joint Staff of the Armed Forces, the secretariats and other bodies, in accordance with the law. ( <i>Lei Complementar da Defesa - Complementary Act</i> Nº 136 – 2010/08/25, modifies Complementary Act Nº 97 - 1999/06/09, Sec. 9).
<b>Chile</b> Ministry of National Defence	The Ministry of National Defence is the highest body in assisting the President in its government and administration functions of national defence. ( <i>Ley del Estatuto Orgánico del Ministerio de Defensa Nacional</i> , Nº 20.424 – 2010/02/04, Sec. 3).
<b>Colombia</b> Ministry of National Defence	The Ministry of Defence conducts the Military Forces and the National Police as ordered by the President, formulating and adopting the sector policies, general plans, programmes and projects for the defence of the sovereignty, independence and territorial integrity of the nation as well as to maintain the constitutional order and guarantee a democratic co-existence. The National Ministry of Defence counts on the immediate assistance of the General Commander of the Military Forces, the Commanders of the Armed Forces, the General Director of the National Police and the Vice Minister. ( <i>Decreto por el cual se modifica la estructura del Ministerio de Defensa Nacional y se dictan otras disposiciones</i> , Nº 1.512 – 2000/08/11, Sec. 2, 3, 4 and 5).
<b>Cuba</b> Ministry of the Revolutionary Armed Forces	It is the body responsible for directing, executing and controlling the implementation of the State and Government policy with respect to the country's preparation for defence, the defence of the State sovereignty on the entire national territory, the preparation and execution of armed combat, and the contracting, acquisition, production and use of war material to meet the Ministry of Defence needs. ( <i>Ley de la defensa nacional</i> , Nº 75 – 1994/12/21, Sec. 37).
<b>Dominican Republic</b> Ministry of the Armed Forces	The Ministry of the Armed Forces, closely assisting the President of the Republic, is the highest military authority in all matters related to the command, organization, training and administration of the armed corps. ( <i>Ley Orgánica de las Fuerzas Armadas</i> , Nº 873 – 1978/08/08, Sec. 50).
<b>Ecuador</b> Ministry of National Defence	It is the political, strategic and administrative body of national defence. ( <i>Ley Orgánica de la Defensa Nacional</i> , Nº 74 – 2007/01/19, Sec. 8).
<b>El Salvador</b> Ministry of National Defence	It is the main advisory body of the President of the Republic and General Commander of the Armed Forces in relation to national defence. It directs the military field of action. ( <i>Ley de la defensa nacional</i> , DL Nº 948 – 2002/10/03, Sec. 19).
<b>Guatemala</b> Ministry of National Defence	The Minister of National Defence, under the orders of the General Commander in Chief of the Army (the President), shall conduct and manage the Army of Guatemala. It is the communication agency between the Army of Guatemala and the other government bodies. ( <i>Ley constitutiva del Ejército de Guatemala</i> , DL Nº 72-90 – 1990/12/13, Sec. 15 and 17).
<b>Honduras</b> Secretary of National Defence	It ensures that the national defence policy is duly executed by the Armed Forces; it represents Honduras at international defence bodies; and it authorizes, regulates and controls all matters related to weapons, ammunitions and explosives. In relation to military matters, it is the administrative organization of the Armed Forces; it countersigns decrees, agreements, orders and decisions; it secures the preparation and implementation of plans and programs, and orders their elaboration or update; it recommends officer promotions to the President; and supervises, inspects and exerts control over the organization and performance of the Armed Forces. ( <i>Ley constitutiva de las Fuerzas Armadas</i> , Decree Nº 39-2001 – 2001/10/29, Sec. 5).
<b>Mexico</b> Secretariat of National Defence	The Secretary of National Defence exercises the High Command of the Army and the Air Force; is responsible for organizing, equipping, educating, training, instructing and managing the Ground and Air Forces, in conformity with the instructions issued by the President of the Republic. ( <i>Ley orgánica del Ejército y la Fuerza Aérea</i> , DOF 1986/12/26. Last amendment: DOF 2009/06/12, Sec. 16 and 17).
Secretariat of the Navy	The Secretary of the Navy exercises the High Command of the Mexican Navy. ( <i>Ley orgánica de la Armada de México</i> , DOF 2002/12/30. Last amendment: DOF 2009/06/12, Sec. 7).
<b>Nicaragua</b> Ministry of Defence	By delegation of the President of the Republic, the Ministry of Defence conducts the elaboration of policies and strategies for the defence of the sovereignty, independence and territorial integrity of the country. ( <i>Ley de organización, competencia y procedimientos del Poder Ejecutivo</i> , Nº 612 – 2007/01/29, Sec. 3).
<b>Paraguay</b> Ministry of National Defence	The administrative responsibilities of the Nation's Armed Forces fall under the National Ministry of Defence. ( <i>Ley de organización general de las Fuerzas Armadas de la Nación</i> , Nº 74 – 1991/11/20. Last amendment: Act Nº 216 – 1993/06/16, Sec. 48).
<b>Peru</b> Ministry of Defence	It is the main executor body of the national security and defence system, responsible for formulating, coordinating, implementing, executing and supervising the national defence policy in the military sphere, as well as for designing, planning and coordinating this policy in the non-military arena, in accordance with current laws in effect. ( <i>Ley del sistema de seguridad y defensa nacional</i> , Nº 28.478 – 2005/03/23, Sec. 18).
<b>Uruguay</b> Ministry of National Defence	It has the power and competence over the political conduct of national defence areas determined by the laws and the Executive Branch within the framework of their powers, in particular, of all matters related to the Armed Forces. It exercises the command and supervision of all activities carried out by the Armed Forces. ( <i>Ley marco de defensa nacional</i> , Nº 18.650 – 2010/03/08, Sec. 14 and 15).
<b>Venezuela</b> Ministry of the People's Power for Defence	It is the highest administrative body as regards the military defence of the Nation, responsible for the formulation, adoption, monitoring and assessment of the policies, strategies, plans, programs and projects of the defence sector. The President and Commander-in-Chief is entitled to issue operational orders through the Ministry of the People's Power for Defence. ( <i>Ley orgánica de la Fuerza Armada Nacional Bolivariana</i> , GO Nº 6.239 – 2009/08/13. Last amendment: Act Nº 6.239 – 2009/10/12, Sec. 11 and 20).

Source: Compilation based on the above mentioned legislation.



**Institutional Guidance**

Country	Can the military members become Ministers of Defence?	Number of military members who became Ministers of Defence	Number of civilians who were Ministers of Defence	Date of creation of the Ministry
Argentina	Yes (if they have retired)	4	33	1958
Bolivia	Yes (if they have retired)	39	37	1933
Brazil	Yes (if they have retired)	None	5	1999
Chile	Yes (if they have retired)	18	31	1932
Colombia	Yes (if they have retired)	12	13	1965
Cuba	Yes	1	1	1959
Dominican Republic	Yes	36	3	1930
Ecuador	Yes (if they have retired)	33	20	1935
El Salvador	Yes	26	None	1939
Guatemala	Yes (1)	12 <sup>2</sup>	None	1945
Honduras	Yes (if they have retired)	None <sup>3</sup>	4 <sup>3</sup>	1954
Mexico	Secretariat of National Defence	14	None	1937
	Secretariat of the Navy	15	3	1940
Nicaragua	Yes (if they have retired)	2	7	1979
Paraguay	Yes (if they have retired)	18	5	1943
Peru	Yes	11	6	1987
Uruguay	Yes (if they have retired)	15	22	1935
Venezuela	Yes	39	1	1946

1. According to the Constitution of the Republic, civilians cannot become Ministers of Defence.
2. Since 1996, year of the Lasting and Consistent Peace Agreements.
3. Since 1998, year of the constitutional reform.

**Source:** Compilation based on information provided by the Ministries and Departments of Defence of each country. The Ministers and Secretaries currently in charge are not considered (September 2010). The creation date is related to the time in which the term "Defence" becomes part of the Institution's name (except of the Ministry of the Revolutionary Armed Forces from Cuba, the Ministry of the Armed Forces from Dominican Republic, and the Secretariat of the Navy from Mexico).

**Breakdown of Present Ministers**

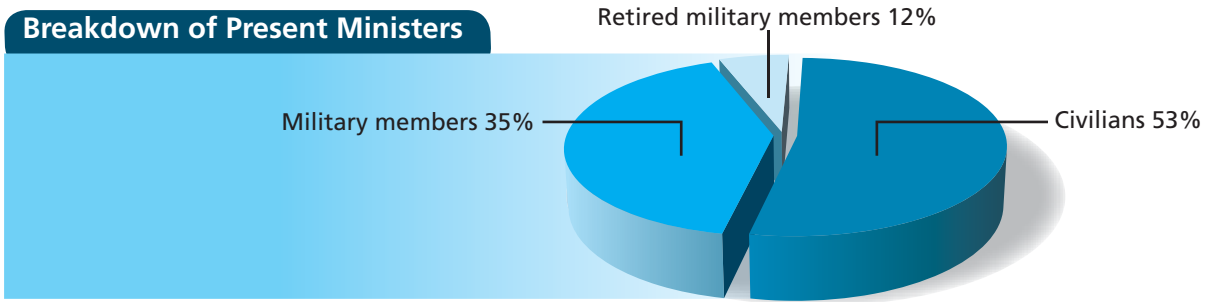

**Ministries of Defence Leadership, 1980-2010 (in %)**

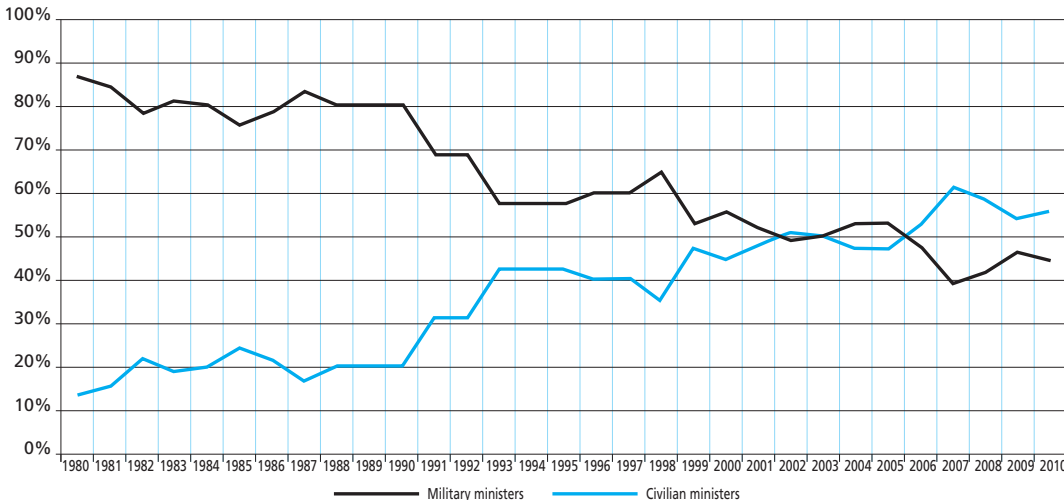

**Note:** All countries included in this publication have been considered. Percentages include all existing ministries on a particular year. Peru is considered since 1987 and Brazil since 1999.

**Source:** Compilation based on the information provided by the Ministries of Defence and Secretariats of each country. This chart considers Ministers and Secretaries currently in charge. As for September 2010 Nicaragua does not have a Minister of Defence. In the case of Mexico, both the Secretary of National Defence (including the Ground and Air Force) and the Secretary of the Navy were considered.

### Evolution of Defence Ministry Structures, 2005-2010 (in %)

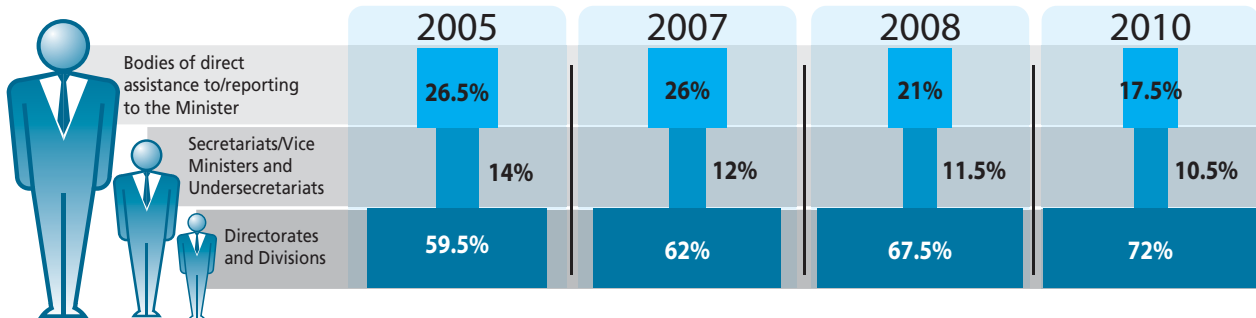

**Note:** The comparison includes the following countries: Argentina, Bolivia, Brazil, Chile, Colombia, Dominican Republic, Ecuador, El Salvador, Guatemala, Honduras, Nicaragua, Paraguay, Peru, Uruguay and Venezuela. In the case of “Directorates”, other equivalent offices, departments and divisions are included according to each country’s denominations, in order to complete this category. Bodies of the Armed Forces, the Defence Councils, sports committees or federations, the military bishopric, companies and industries, schools and other institutes or study centres have been excluded for the purposes of comparison.

**Source:** Compilation based on the organization charts provided by the Ministries and Departments of Defence of each country.

### National Defence and/or Security Council Officials (in %)

Countries: Argentina, Bolivia, Brazil, Chile, Colombia, Cuba, Ecuador, El Salvador, Guatemala, Mexico, Nicaragua, Paraguay, Peru, Uruguay and Venezuela.

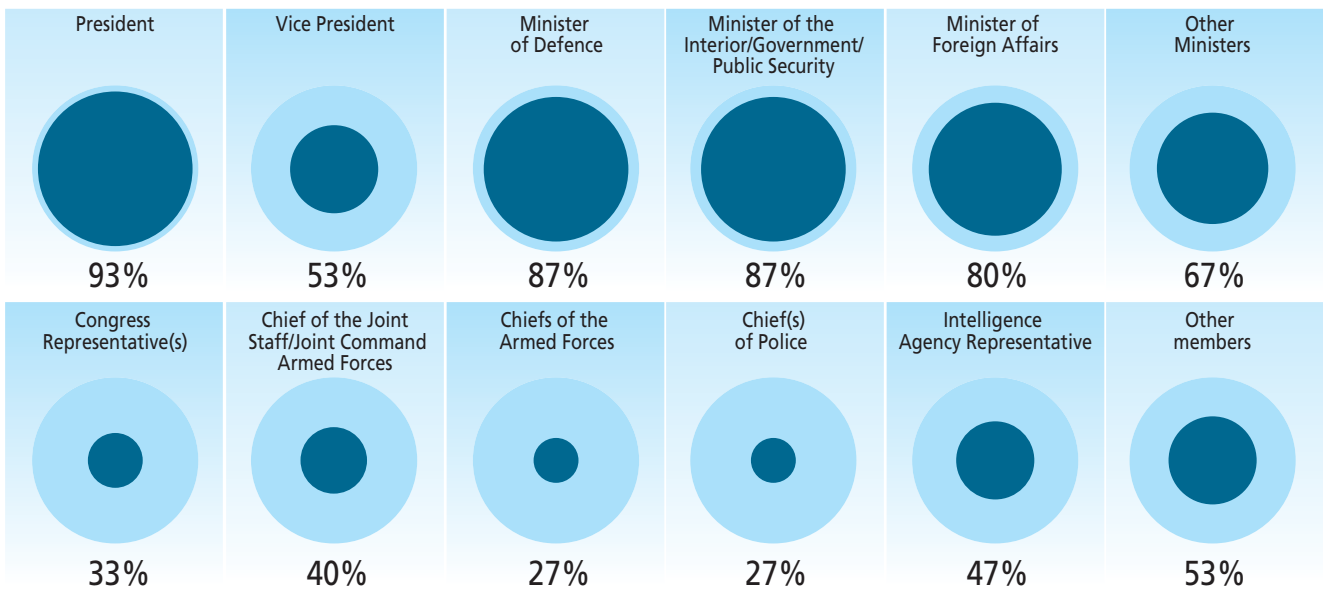

**Note:** Although Section 287 of the Honduran Political Constitution orders to “create the National Defence and Security Council and to establish a special law to regulate its organization and operation” this regulation has not been created so far. Sec. 258 of the Dominican Republic’s Political Constitution, dated 2010/01/26 also establishes the creation of a National Defence and Security Council. When this edition closed, the regulations on its composition and operation were still pending.

**Source:** *Ley de defensa nacional* (Nº 23.554 - 1988/05/05) and *Libro blanco de la Defensa Nacional* (1999) (Argentina). Political Constitution, *Ley de organización del Poder Ejecutivo* (Nº 2.446 - 2003/03/19), and *Ley sobre la organización y funcionamiento del Consejo de Defensa Nacional* (Nº 8.183 - 1991/04/11. Last amendment: 2001/08/31) (Brazil). Political Constitution and *Libro de la defensa nacional de Chile* (2010). *Decreto por el cual se fusionan el Consejo Nacional de Seguridad, el Consejo Superior de la Defensa Nacional y la Comisión creada por el Decreto 813 de 1983* (Nº 2.134 - 1992/12/30) (Colombia). *Ley de la defensa nacional* (Nº 75 - 1994/12/21) (Cuba). *Ley de seguridad pública y del Estado* (Nº 35 - 2009/09/28) (Ecuador). *Decreto de creación del Consejo de Seguridad Nacional* (Nº 168 - 1992/09/11. Last amendment: DE Nº 1 - 2005/01/12) (El Salvador). *Ley marco del sistema nacional de seguridad* (DL Nº 18-2008 - 2008/04/15) (Guatemala). *Ley de seguridad nacional* (DOF 2005/01/31. Last amendment: DOF 2005/12/26) (Mexico). *Reglamento a la Ley Nº 290 de Organización y Competencia, Procedimientos del Poder Ejecutivo* (D-71-98 - 1998/10/31. Last amendment: Decree Nº 19 - 2010/05/13) (Nicaragua). *Ley de defensa nacional y de seguridad interna* (Nº 1.337 - 1999/04/14) (Paraguay). *Ley del sistema de seguridad y defensa nacional* (Nº 28.478 - 2005/03/23) (Peru). *Ley marco de defensa nacional* (Nº 18.650 - 2010/03/08) (Uruguay). *Political Constitution and Ley orgánica de seguridad de la Nación* (GO Nº 37.594 - 2002/12/18) (Venezuela).

Only 5 countries include members of Congress in their Defence Councils



### Constitutional Powers of the Congress

Country	Related to War and Peace		Related to the entry and deployment of troops		Related to Control
	Can it declare war?	Can it make peace?	Is a congressional authorization necessary for the entry of foreign troops?	Is a congressional authorization necessary for the deployment of national troops outside the country?	Is its approval required to appoint senior officers of the Armed Forces?
Argentina	No	No	Yes	Yes	Yes <sup>1</sup>
Bolivia	No	No	Yes	Yes	Yes <sup>1</sup>
Brazil	No	No	Yes	N/R	No
Chile	No	No	Yes	Yes	No
Colombia	No	No	Yes <sup>1</sup>	N/R	Yes <sup>1</sup>
Cuba	Yes	Yes	N/R	N/R	N/R
Dominican Republic	No	No	Yes <sup>1</sup>	Yes <sup>1</sup>	No
Ecuador	No	No	N/R	N/R	No
El Salvador	Yes	No	Yes	N/R	No
Guatemala	Yes	No	Yes	N/R	No
Honduras	Yes	Yes	Yes	Yes	Yes
Mexico	Yes	No	Yes <sup>1</sup>	Yes <sup>1</sup>	Yes <sup>1</sup>
Nicaragua	No	No	Yes	Yes	N/R
Paraguay	No	No	Yes	Yes	Yes <sup>1</sup>
Peru	No	No	Yes	N/R	No
Uruguay	Yes	No	Yes	Yes	Yes <sup>1</sup>
Venezuela	No	No	Yes	Yes	No

N/R: No reference. (1) Corresponds to the Senate.

Source: Compilation based on the Constitution of each country.

### Bills introduced in the Defence Commissions classified by subject, 2009 (in %)

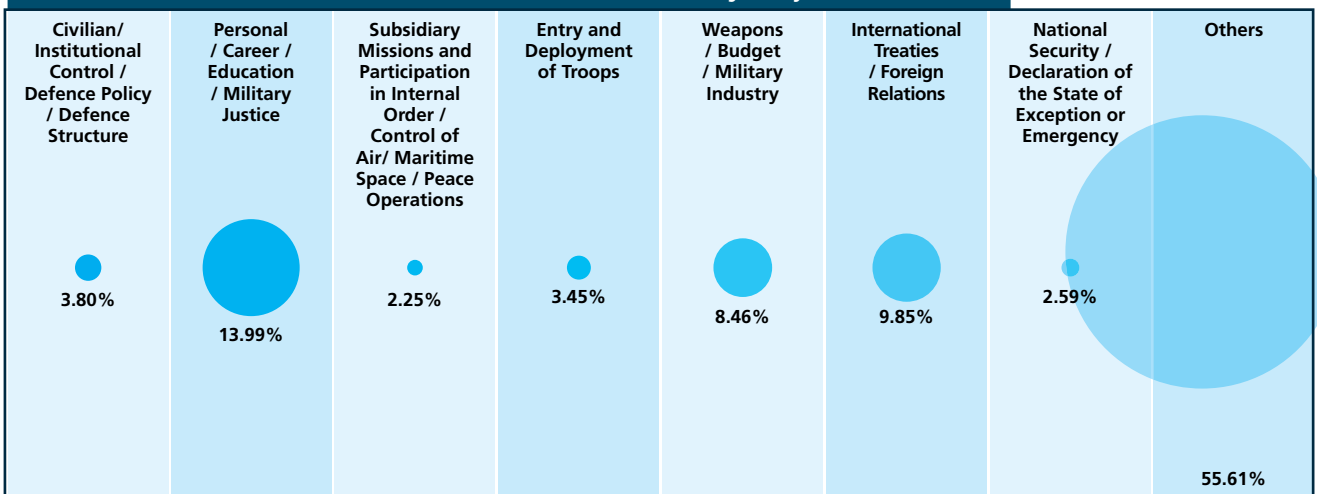

**Note:** The dates set for project submission were January 1, 2009, to December 31, 2009. In the cases where legislatures start sessions in the middle of the year, the project is considered by date and not by period. The "others" category includes subjects such as: new island designations; Malvinas War; transfer of titles and real assets; declaration of historic monuments or sites; national migration system; various celebrations; life tributes; military card gratuity; declaration of national holidays for various reasons; regulations for citizens living abroad; automotive registration system; amendments to the criminal code; regulation of the constitutional section on national budget; changes to the electoral code; Sale of State-owned companies; Supreme Court of Justice; Agrarian Technology Institute; granting of honorary nationality; capital status; Transport Department; intensive care; punishment of terrorist acts; civil servant participation; party election positions; Particular pardons and amnesties; regulation of pyrotechnic products; commemorative parades of various anniversaries. In the case of Brazil, Congress Legislative Decrees have been included under the "Others" category.

**Source:** National Defence Committees of the Congress Houses (Argentina). The Bolivian Armed Forces, Police and State Security Senate Committee and Government, the Defence and Armed Force Committee of the House of Representatives (Bolivia). Foreign Relations and National Defence Committee of the Senate and Foreign Relations and National Defence Committee of the House of Representatives (Brazil). National Defence Committees of Congress (Chile). Senate Second Committee and House Second Committee (Colombia). National Defence Committee of the National Assembly of the People's Power (Cuba). National Defence and Security Senate Committee and National Defence and Security Committee of the House of Representatives (Dominican Republic). Committee on Sovereignty, Integration, International Affairs and Integral Security of the National Assembly (Ecuador). Defence Committee of the Legislative Assembly (El Salvador). National Defence Committee of the Congress of the Republic (Guatemala). National Defence Committee of the National Congress (Honduras). National Defence Committees of the Congress Houses (Mexico). Committee on Peace, Defence, Government and Human Rights of the National Assembly (Nicaragua). Committee on Constitutional Affairs, National Defence and Public Forces of the Senate and Committee on National Defence, Security and Internal Order of the House of Representatives (Paraguay). Committee on National Defence, Internal Order, Alternative Development and Fight Against Drugs of the Congress of the Republic (Peru). Senate National Defence Committee and House National Defence Committee (Uruguay). Venezuela: The National Assembly did not report any projects for 2009.

## States of Exception

Country	Name	Cause	Participation of the Legislative Power
Argentina	State of siege.	Internal commotion.	Declared by the Congress and by the President if the latter were not in session (with a subsequent report).
		Foreign attack.	Requires the approval of the Senate.
Bolivia	State of exception.	Danger for State security. External threat. Internal unrest. Natural disaster.	It requires the approval of the Plurinational Legislative Assembly.
Brazil	State of defence.	Grave or imminent institutional instability. Natural calamities of great proportions. Grave commotion of national impact.	Requires the approval of the Congress.
	State of siege.	Situations which prove the inefficiency of the state of defence. Declaration of the state of war. Response to an armed foreign attack.	
Chile	State of assembly.	External war.	Requires the approval of the Congress.
	State of siege.	Internal war. Grave internal commotion.	
	State of catastrophe.	Public calamity.	The President shall inform the Congress of the measures adopted. Requires the approval of the Congress in case they are extended for more than a year.
	State of emergency.	Grave disturbance of the public order. Grave damage to national security.	The President shall inform the Congress of the measures adopted. Requires the approval of the Congress in case they are extended for more than fifteen days.
Colombia	State of external war.	External war.	Requires the approval of the Senate except when it is necessary to repel aggression.
	State of internal commotion.	Grave disturbance of the public order.	The declaration of a third consecutive period requires the approval of the Senate.
	State of emergency.	Situations which disturb or seriously threaten to imminently disturb the economic, social and ecological order or which constitute public calamity.	The Congress shall examine the causes and measures which determined it and those adopted, and shall expressly rule on the convenience and timeliness of such measures.
Cuba	State of emergency.	Imminent natural disasters or catastrophes. Circumstances affecting internal order, national security or stability.	The National Assembly of People's Power must be informed.
Dominican Republic	State of national defence.	Cases in which national sovereignty or territorial integrity are under grave or imminent danger due to armed foreign attacks.	Congress shall have the power to declare it and the Executive Branch shall have the power to request its declaration.
	State of internal commotion.	Grave disturbance of public order causing an immediate threat to institutional stability.	Requires Congress approval.
	State of emergency.	Events disturbing or seriously threatening to disturb the country's economic, social and environmental order or which constitute a public catastrophe.	
Ecuador	State of exception.	Case of aggression. International or internal armed conflict. Grave internal disturbance. Public disaster. Natural disaster.	The National Assembly, which has the authority to revoke the decree at any time, must be informed.
El Salvador	Exception regime.	War. Invasion of the territory. Rebellion. Sedition. Catastrophe. Epidemics or general calamity. Grave disturbances of the public order.	It is decreed by the Legislative or the Executive Power. In case of the suspension of certain guarantees, the approval of the Legislative Power is required.
Guatemala	State of prevention State of alarm State of public calamity State of siege State of war	Invasion of the territory. Grave disturbance of the peace. Activities against the security of the State. Public calamity.	The Congress can ratify, modify or dismiss it.
Honduras	State of siege.	Invasion of the national territory. Grave disturbance of the peace. Epidemics or any general calamity.	The Congress can ratify, modify or dismiss the decree sent by the President within thirty days.
Mexico	Suspension, in all the country or in a specific place, of the guarantees which could constitute an obstacle to cope with the situation in a quick and easy manner.	Invasion. Grave disturbance of the public peace. Any other issue which could put the society in grave danger. Conflict.	Requires the approval of the Congress.
Nicaragua	State of emergency.	When required by: National security. Economic conditions. National catastrophes.	The Assembly can approve, modify or dismiss it.
Paraguay	State of exception.	Armed conflict. Grave internal commotion which puts the Constitution or the bodies established in it in imminent danger.	It can be declared by the Executive Power or the Congress. If it is declared by the Executive Power it requires the approval of the Congress.
	State of defence.	External aggression.	Requires the approval of the Congress.
Peru	State of emergency.	Disturbance of the peace or internal order. Catastrophe or grave circumstances which affect the life of the Nation.	Decreed by the President with the consent of the Council of Ministers. The Congress must be informed about it.
	State of siege.	Invasion. External war. Civil war. Imminent danger of the above mentioned situations.	Decreed by the President with the consent of the Council of Ministers. The Congress must be informed about it. The extension beyond forty five days requires the consent of the Congress.
Uruguay	Quick security measure.	Foreign attack. Internal commotion.	Requires a resolution from the General Assembly.
Venezuela	State of alarm.	Catastrophes and public calamities which seriously endanger the security of the Nation, or its citizens.	The extension requires the approval of the National Assembly.
	State of economic emergency.	Extraordinary economic circumstances which seriously affect the economic situation of the Nation.	
	State of internal or external commotion.	Internal or external conflict which seriously endangers the security of the Nation, its citizens or institutions.	

Note: Copilation based on the Constitution of each country





## Analisis

# The Ministries of Defence and the Political Power

**Juan Rial**

PEITHO

The national States of the region have, since their early days, had a Secretary of State or Minister of War. Their function was traditionally to assist the Head of State and/or government in all aspects related to the conduct of the military, their recruitment, provisioning, pay and the general conduct of operations. However, in several instances, a clear-cut division existed between the administrative and logistic management and the operational command, with the latter usually left exclusively in the hands of the military.

As military forces became more professional, and soldiers or seamen (the grassroots of the military organization, troops and NCOs) became a differentiated corps from that of the so-called military professionals (members of the officer corps), the command structure became more intricate. Initially, in the national European countries, military senior officers had a higher class standing. And the institution of Secretaries of War and of the Navy was progressively introduced. At the beginning, these functions were performed by military commanders themselves.

Since military organizations in the Americas followed the same models, they replicated the differentiation between members of the disciplined personnel at the bottom of the organization and those of the higher ranks in command positions. However, while in most of the more advanced European countries the military were subjected to the political power they served, in the feeble Latin American States the servicemen started to gain, amid a context of constant unrest, a high freedom of action and, for many years, not only did they control the weapons but also became political actors. These circumstances had not been provided for in constitutional instruments and laws, as they had also been devised

according to European moulds.

Some countries called their departments “Ministries of War;” others “Ministries of War and the Navy,” depending on the degree of importance acquired by the naval force. Where the country had significant maritime interests, two different departments would be established. Their power was limited; and the structure, simple and minimal. Normally, it only served as a personnel and military payroll office and as liaison with other government departments. As the aviation developed, countries created Secretariats or Ministries of the Air Force, not only comprising military responsibilities, but also civilian roles such as airport control and civil aviation administration, as was the case in Argentina with the Department of Aeronautics (*Secretaría de Aeronáutica*), a ministry-level agency that existed between 1945 and 1958.

During the 1930s, in most countries of the world, after the end of World War I and the conduct of several international disarmament conferences, the name of the Ministry of War was changed to National Defence on the assumption that wars of aggression had been abolished. In the countries that from the early 20<sup>th</sup> century were called Latin Americans, the initial Ministries of War and Navy also adopted the denomination of Ministries of National Defence, but with some exceptions: in those nations where military autonomy was high, each service had its own Secretary of State. Brazil, for instance, maintained three Ministries (one for each military service) until 1999 and Peru kept the same until one year earlier.

In many countries of the region, the predominant role that the military had in the political sphere determined a strong autonomy and that is why in many cases the

ministries were solely an administrative and logistics office at the service of the military forces and acting as a liaison with the rest of the State. The Ministry was considered an agency of the armed forces rather than an actual State Secretariat. Some of the legal provisions referring to the Ministries were included in the organic laws for the military forces, which in some instances remains unchanged.

With the (re)democratization process virtually commenced in the '80s, almost all countries started a process seeking effective conduct of military organizations by the legal and legitimate authorities, instituted according to the democratic rules that assume the prevalence of elected authorities. The process implied that Ministries of Defence little by little started to become the actual leaders of the area, managing defence policies, resource allocation and controlling military careers and personnel.

In many instances, constitutional and legal adjustments (some of them still underway) were required and the political and military personnel involved in these matters had to devise accommodation and conduct practices. The various countries obtained different results. A significant point to be underscored is the gap between what legal provisions mandate and what the common practice is. In many countries the former are more advanced than the latter.

In a very general way, it can be said that models range from those where the Ministry of Defence has the control of the force in its capacity as the specialized institution of the Executive Branch (in all instances acting under the instructions of the Executive Branch as Commander-in-Chief of the whole military structure and responsible for the conduct of the defence) to models in which the armed forces operate with the greatest autonomy and only respond to the Presidency as an institution which is the symbol of the very existence of the State.

Many of the existing legal bodies provide for a National Defence Council, which usually is never called nor does it meet. Their natural members, especially those in the financial area, do not want to get involved in the matter, knowing that the only thing to be discussed is a demand for funds, which they try to avoid in order to maintain fiscal discipline.

Usually, a military chief is included, who responds for all of the armed forces. Also in this respect there are opposite examples. In some cases, it is part of the old autonomization process and the predominance of

the land force. In this situation the general commander of the military forces, generally bypasses the ministerial instance and talks directly to the Head of the State. In more modern organizations, a joint administrative and logistic order is sought which usually has an operating scope. In those cases the Chief of the Joint Staff is supposed to be above the commanders of each force. But this figure, in more than a country, is more a coordinator than an effective commander.

### **Reflexions on the models**

Of the cases where the Ministry exercises the authority delegated by the President, Argentina is clearly an example, followed by Brazil, Chile, Colombia, Peru and Uruguay. Joint bodies, up to the present moment, are in practice over passed by each force's commander. But peculiarities exist in each one of those countries. Argentina is the country where the elected authority has the most control over its services. Colombia follows this model although, in legal terms, the Ministry is nothing but an administrative body. But in practice, it is closer to this model. Also Brazil, above after the law that strengthens the Ministry and names a Joint Staff was passed. Although the legal rule states that the Ministry of Defence is an advisor to the President as the Commander in Chief, it also sustains that the armed forces are subordinated to the Ministry of Defence. This type of contradictions in legal instruments is very common. It is for this reason that military subordination greatly depends on effective practices and leadership.

Bolivia is an example of the second model, where the Ministry has a different role, followed by Ecuador. Although in both countries there is a trend to an effective command of the President over the military structure, history shows the predominance of post-modern and neo-populist leaders ('caudillos') with strong popular support. The Ministries in fact act as mere presidential delegates and legal structures are somewhat confusing, especially after the approval of new Constitutions that have not had their correlative legal instruments dealing specifically with military conduct.

In a third model, the clearest example is Nicaragua. There is a very high autonomization of the unified military force (the Army). And, for historical and political reasons, no person has been named to lead the Ministry. After becoming the national Army, the military force has resisted political control by the party and the leader that created it.



In legal terms, it is also the case of Paraguay, but the Minister here sustains a significant fight to exercise command. The same happens in Guatemala, Honduras and El Salvador, where high autonomy has been inherited in spite of the fact that the Ministry is supposed to be higher along the line of command over the military forces. Amid disputes between politicians and the military, this is also the case in the Dominican Republic. In all these countries legal provisions on Defence Ministries or Secretariats are parts of the legislation on the military.

Venezuela makes the fourth example. In recent years, the President subordinates the military force but as counterbalance, it has a new institution going through a slow process of creation: a Militia which competes with the professional force and responds directly to the Commander-in-Chief (President).

A fifth example is the special case of Mexico, where the military forces, for historical reasons, had two separate commands: one for the Army and the Air Force (the Secretariat for National Defence); and another for the navy (the Secretariat of the Navy). In the past, the commanders and officers were all members of the governing party, the PRI, but they were exclusively military and took no part in everyday political conduct. With the political reforms of the '90s they ceased their party affiliation but the military character of both Secretariats remained unchanged.

A sixth model refers to Cuba. The command is in the hands of the Chief, who is also President of the State Council and the Council of Ministers. At the same time, he is the General Secretary of the Communist Party of Cuba. Following the illness of Fidel Castro, these positions have been occupied by his brother Raul, except for the Cuban Communist Party (PCC) where he still is Second General Secretary. Raul Castro was Minister of the Armed Forces, an agency now under charge of General Julio Casas Regueiro, who is also a member of the PCC's political bureau. Control in Cuba is exercised by the political force, the only one existing in the country, but its peculiar history makes key roles to be held by individuals who are, at the same time, politicians and service men.

The seventh example includes many Caribbean states,

which do not have Armed Forces but police organizations.

At the time of writing this paper, the process of change is still in progress in many countries, specifically in Brazil and Uruguay, where it is assumed that the new chiefs of staffs will have a significant role in military reform as it belongs with the new institutions. The new White Book on Defence already published by Chile, the one to be issued in Argentina before the end of 2010, and the one established by law in Brazil to be prepared every four years, also show a change that tends to affirm the supremacy of the political power legitimately and legally constituted, over the military forces. At present, all processes are geared to solving problems of the pre-democratic past, while, on the other hand, new problems are appearing for which there is not yet a precise formulation of the questions to be addressed and much the less, of course, their potential answers.

Said questions refer, for example, to the forms that defence institutions will assume in countries that have defined themselves as plurinational (including Bolivia and Ecuador); or the potential reach of defence institutions vis-à-vis regional international organizations such as the South American Defence Council. In the same manner, recruiting problems also show two potential models: the one where military service is maintained, to a large extent of a voluntary character although the majority of the force is paid (in an attempt to obtain greater social cohesion, and avoid class differences); and the one aiming at a professional force at all levels. The issue of military education and training has not been raised yet, especially among commissioned officers, nor has the reach of the reform of military affairs.

Recent history problems, the strong differentiation of defence and internal security, as well as whether or not the armed forces should be involved in national development activities are already part of the current debate and ministry institutions will have a lot to say in this respect. Whether or not supplementary forces should exist will be an issue for debate in a short time. And the discussion on military industry and equipment is just about to come, or fully underway.

Chapter 3:

# The Budgets

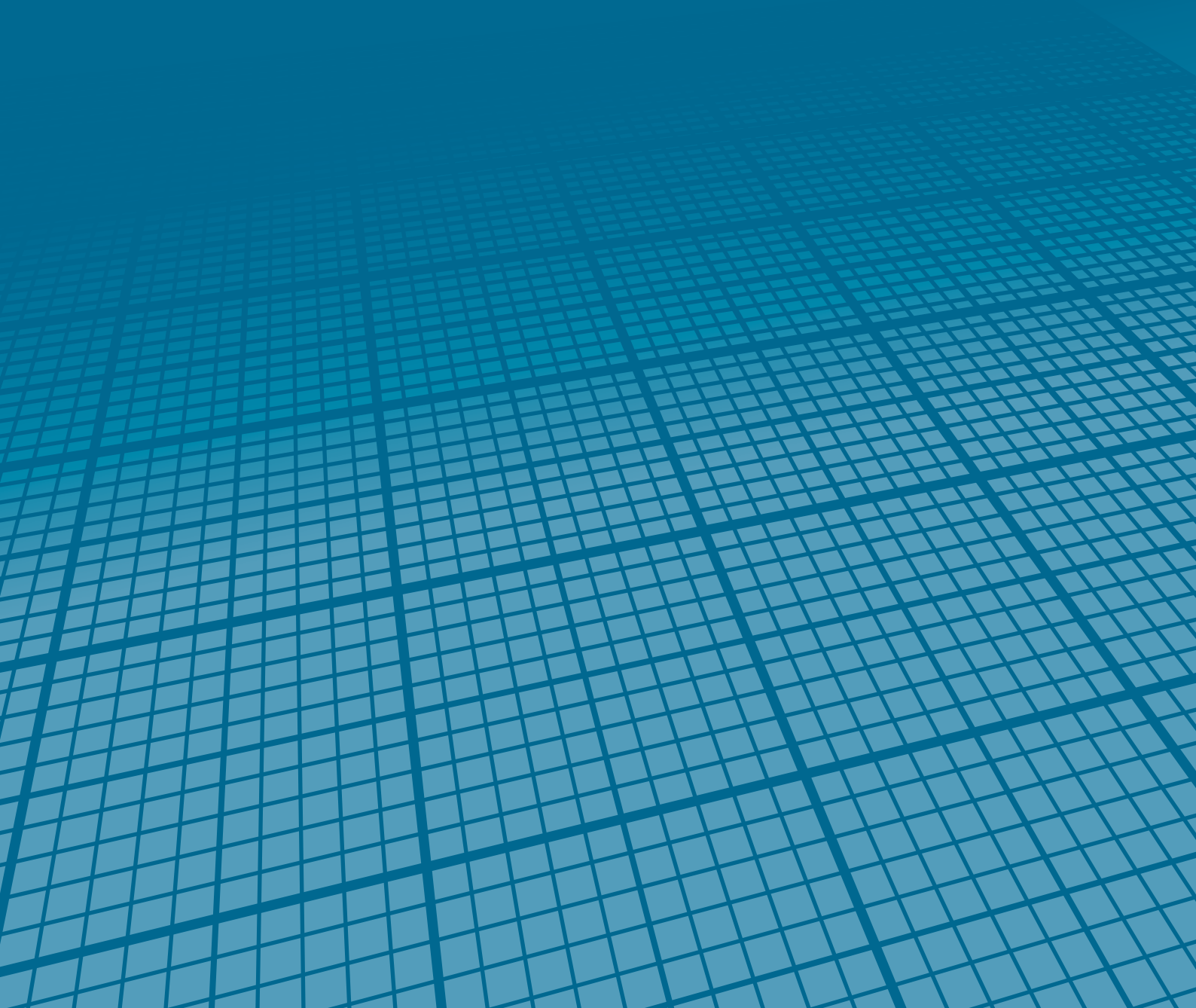



### Defence Budget (in US\$)

Country	2006	2007	2008	2009	2010
Argentina	1,952,165,821	2,120,829,805	2,628,157,098	2,849,654,256	3,138,200,705
Bolivia	197,291,177	193,405,756	254,520,509	307,478,493	336,894,359
Brazil	13,692,057,669	20,973,055,774	26,202,709,813	25,911,333,511	33,055,029,481
Chile	3,177,404,842	4,276,790,277	4,459,645,809	4,353,450,717	4,778,329,754
Colombia	2,872,392,573	4,105,180,855	6,004,957,107	5,534,277,720	6,178,261,917
Cuba*	71,162,500	78,850,000	84,233,333	88,591,667	91,920,833
Dominican Republic	213,117,635	265,058,384	269,120,373	311,355,315	332,298,929
Ecuador	953,125,534	1,168,229,152	1,389,330,906	1,679,073,897	2,156,832,116
El Salvador	106,363,230	111,400,520	115,409,495	132,861,405	132,874,110
Guatemala	134,476,326	152,106,898	156,210,263	153,090,192	159,860,766
Honduras	63,175,260	86,837,651	121,183,088	127,963,147	172,194,128
Mexico	3,288,106,264	4,184,285,440	4,706,150,462	4,681,259,477	4,875,854,577
Nicaragua	36,293,492	39,336,274	42,191,833	37,293,776	39,644,293
Paraguay	95,572,924	126,711,873	149,580,691	176,769,687	227,582,002
Peru	1,086,270,304	1,252,580,042	1,515,727,130	1,600,023,237	2,067,397,486
Uruguay	215,709,213	290,335,815	316,844,107	322,261,459	375,059,540
Venezuela	1,867,024,633	2,612,441,958	3,351,756,259	4,185,502,812	2,501,244,477
<b>TOTAL</b>	<b>30,021,709,396</b>	<b>42,037,436,475</b>	<b>51,767,728,276</b>	<b>52,452,240,769</b>	<b>60,619,479,474</b>
<b>Variation %</b>	<b>0.00%</b>	<b>40.02%</b>	<b>23.15%</b>	<b>1.32%</b>	<b>15.57%</b>

\* Cuba: "Defence and Internal Order" budget.

### Growth Comparison (2006-2010)

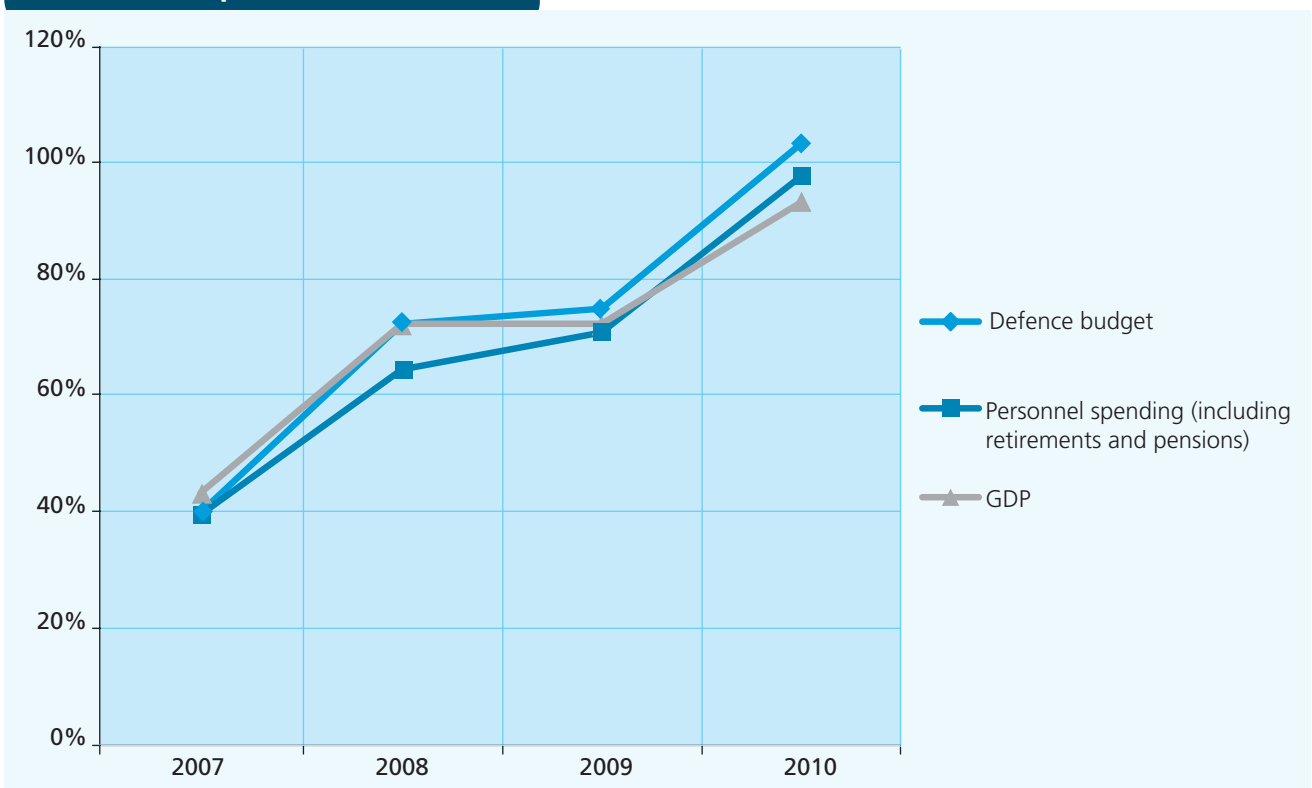

Note: Cuba is not included. 2006 represents the 0 level of variations.

### Defence Budget in Latin America (in %)

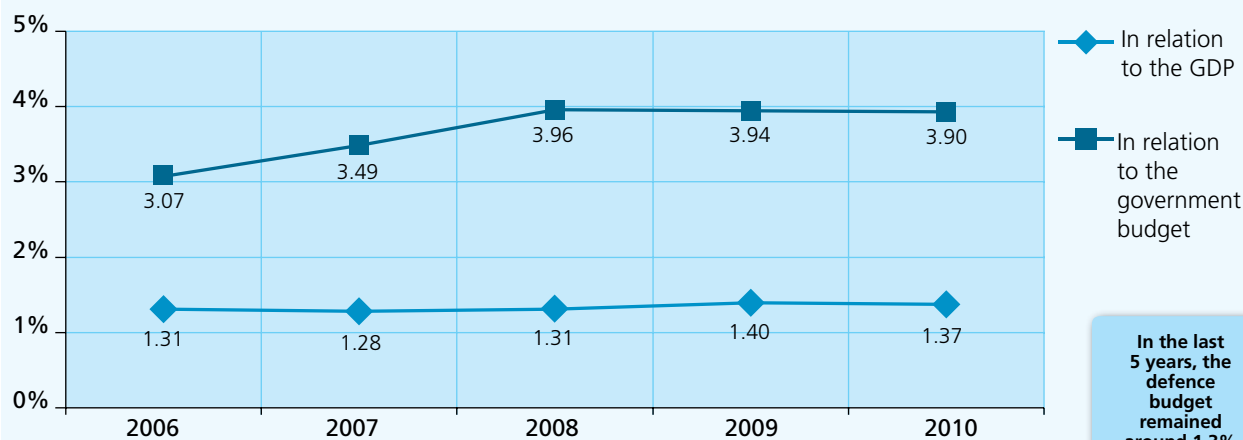

In the last 5 years, the defence budget share in Latin American government budgets averaged 3.7%.

In the last 5 years, the defence budget remained around 1.3% of Latin American GDP

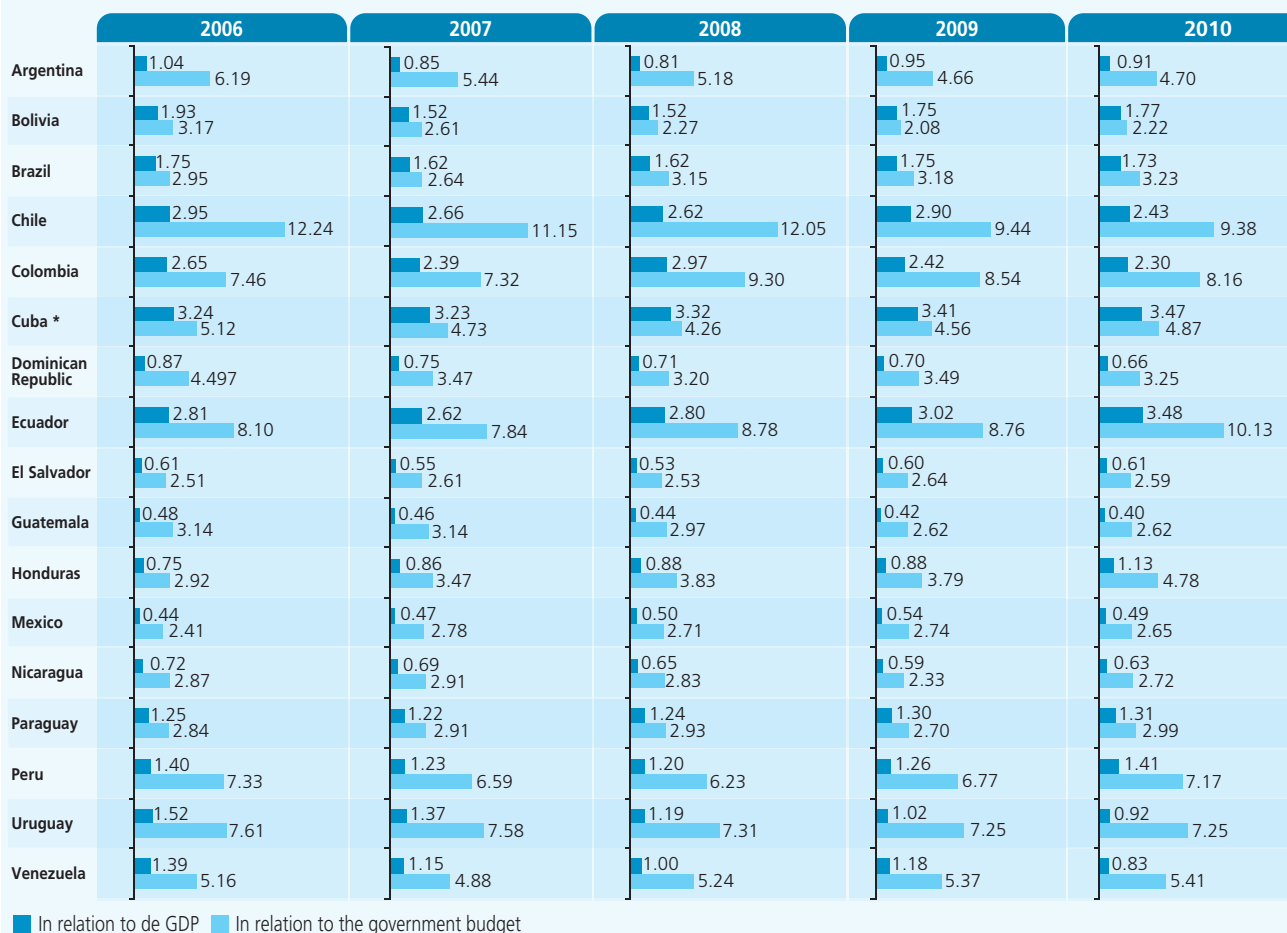

\* Cuba: "Defence and Internal Order" budget.

**Source:** Compilation based on the budget laws of each country. In the case of Cuba, 2006, 2007, 2008 and 2009 figures correspond to government budget execution (*Anuario Estadístico de Cuba 2009*). The dollar exchange rate considered is that provided by the World Economic Outlook Database, IMF, for each year under review. This source has been taken for comparative purposes. Cuba: *Anuario Estadístico de Cuba 2009* and 2010 estimates of the Ministry of Economy and Planning.

The defence budget is made up of all funds allocated to meet the needs of the defence system, regardless of the specific institutional classification expressed in the respective budgets. Only in the case of Cuba, the "Defence and Internal Order" activity is considered, as expressed in the Cuban budget. Headquarter Administration, Decentralized organizations and Social Security items are included. For further details, see Section "The Countries" from this publication. In the case of Chile and Peru, out-of-budget spending forecasts provided for by law have been included.



**GDP – Defence Budget- GDP Growth Comparison (2006-2010)**

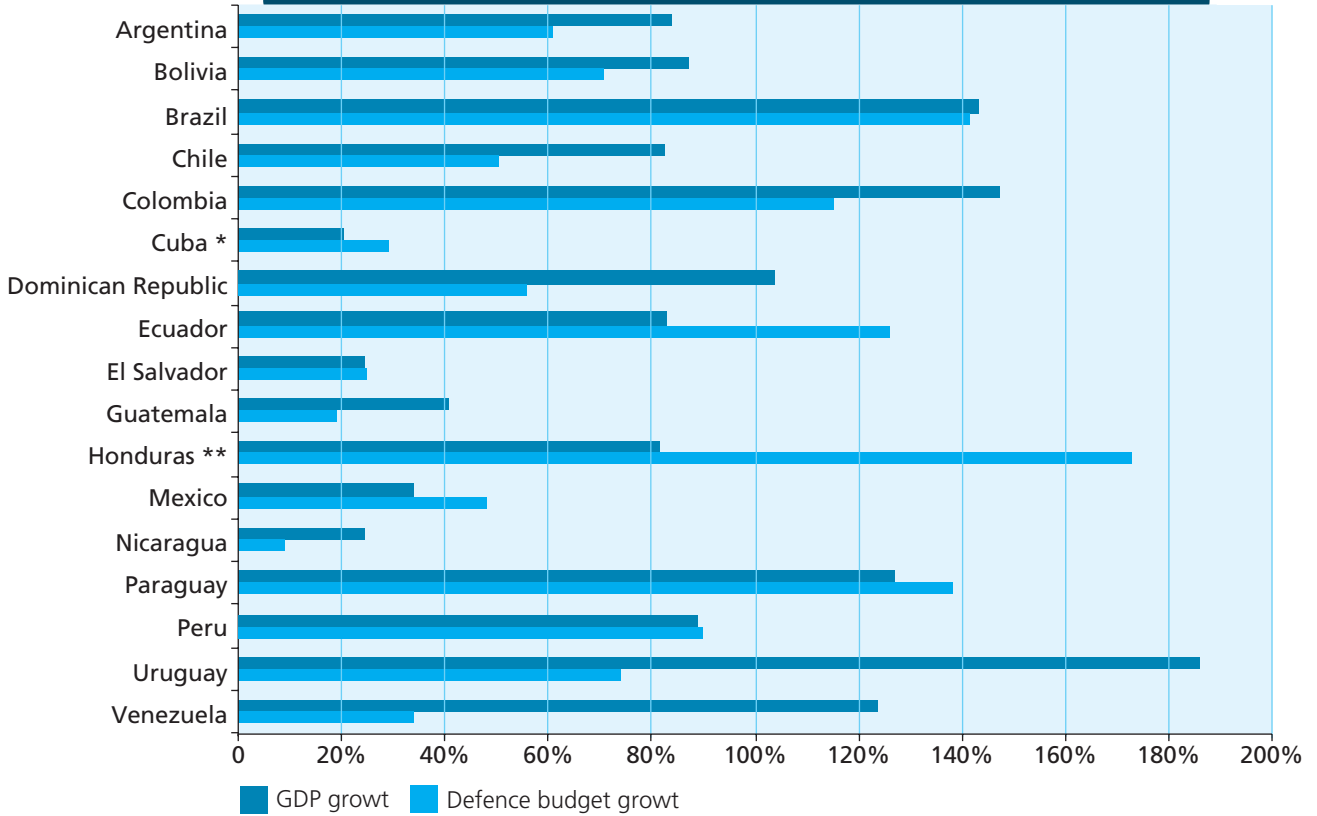

\* Cuba: "Defence and Internal Order" activity budget.

\*\* Honduras: Retirement and pensions of police officers and firefighters incorporated as members of the Institute of Military Social Security are included as from 2007. No breakdown has been made to the budget items.

**Defence Budget Share in the Overall Government Budget (2006-2010 variation)**

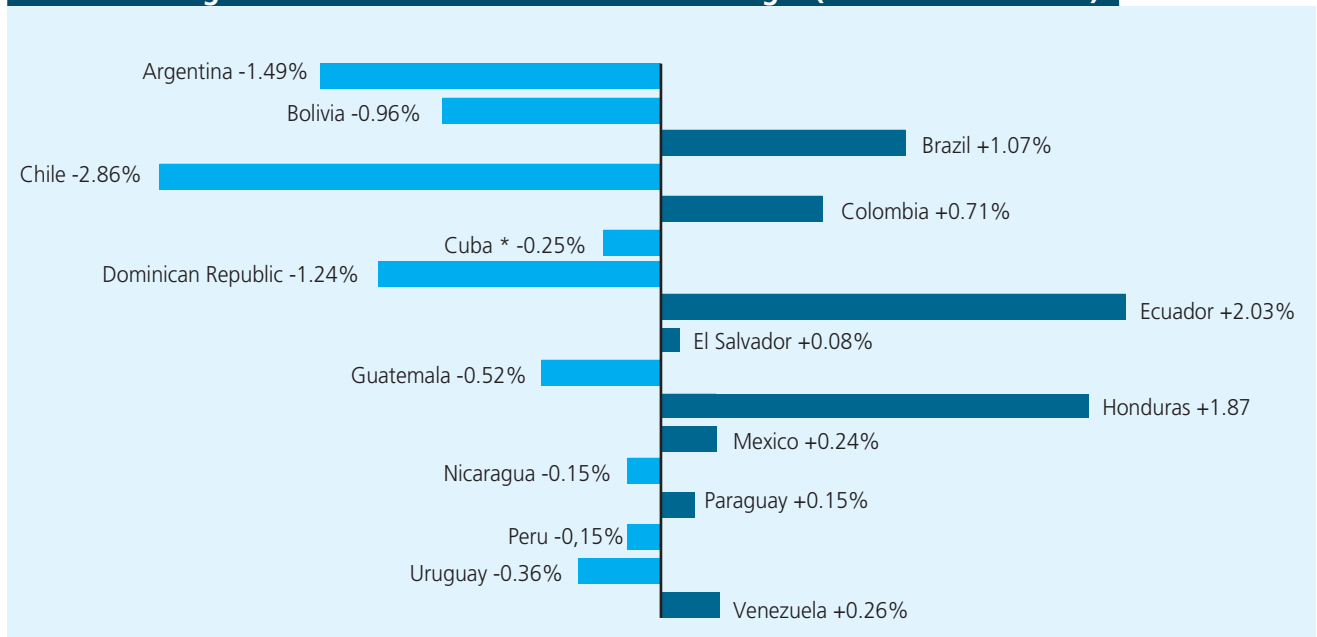

\* Cuba: "Defence and Internal Order" activity budget.

### Latin American 2010 Defence Budget Breakdown

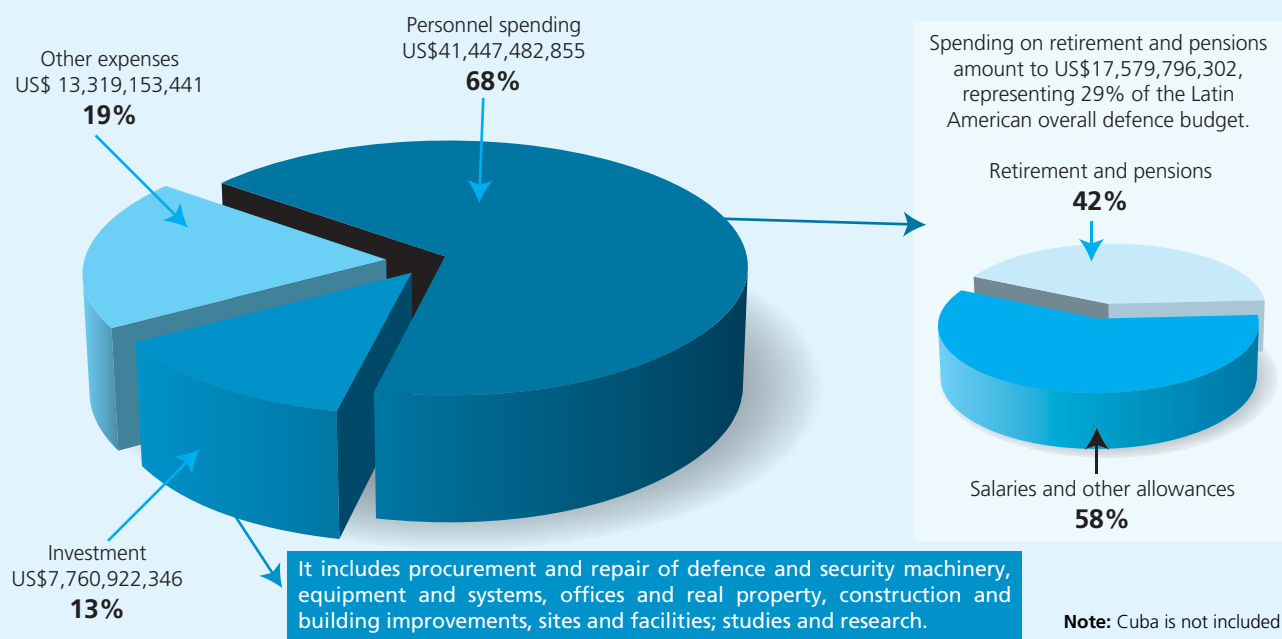

### Personnel and Investment (in %)

Country	2008		2010	
	Personnel	Investment	Personnel	Investment
Argentina	78.7	3.1	75.4	3.1
Bolivia	62.1	5.2	62.2	5.8
Brazil	70.3	10.9	71.6	14.0
Chile*	50.5	31.6	58.4	24.0*
Colombia	43.9	25.5	48.8	14.0
Dominican Republic	73.7	8.7	80.7	4.6
Ecuador	78.5	1.8	73.2	15.3
El Salvador	72.6	7.4	72.6	3.0
Guatemala	66.1	2.3	61.6	1.4
Honduras	71.5	4.9	77.0	0.6
Mexico	78.7	3.0	75.2	5.3
Nicaragua	57.7	2.6	62.6	2.4
Paraguay	84.0	5.7	81.8	7.1
Peru	47.6	7.9	48.4	15.1
Uruguay	73.8	5.4	73.7	5.4
Venezuela	76.7	2.3	82.5	1.6

\* Chile: As a contribution for the country's reconstruction process, in 2010 and 2011 a total of 600 million dollars shall be transferred by the Reserved Copper Law's Fund, in addition to 520 million dollars to fund the repair of military facilities damaged by the past earthquake.

**Source:** Compilation based on the budget laws of each country. Chile: contribution from the reconstruction fund: House of Representatives of Chile. The dollar exchange rate considered is that provided by the World Economic Outlook Database, IMF, for each year under review. This source has been taken for comparative purposes.

The defence budget is made up of all funds allocated to meet the needs of the defence system, regardless of the specific institutional classification expressed in the respective budgets. Headquarter Administration, Decentralized organizations and Social Security items are included.

The following items are considered as "investment": Real direct investment (Argentina); Real assets (Bolivia); Fiscal and social security budget investments and investment budget (Brazil); Acquisition of non-financial assets and investment initiatives, and revenues for the copper fund (Chile); Investment (Colombia); Non-financial assets (Dominican Republic); Annual investment plan (Ecuador); Institutional investment (El Salvador); Properties, plants, equipment and intangible assets (Guatemala); Capital assets acquisition (Honduras); Investment (Mexico); Capital expenses/Machinery and equipment (Nicaragua); Physical investment (Paraguay); Acquisition of non-financial assets and revenues for the Fund for the Armed Forces (Peru); Investment (Uruguay); Real assets (Venezuela). The budget laws of each country present different degrees of details on investments.

For further details, see Section "The Countries" from this publication. In the case of Chile and Peru, out-of-budget spending forecasts provided for by law have been included.





## Analysis:

# Running the Arms Race?

## A Contribution to Debate from a Measured Approach

**Gustavo Sibilla**

*Member of RESDAL*

In mid-2010, the year starting the series of Bicentennial celebrations of independence in several Latin American countries, when one googles the terms “arms race + Latin America”, the search in Spanish leads to 150,000 hits. In English, this figure spikes to 7 million. Although still a long way from more popular subjects, this issue is clearly starting to show up in at least some academic analyses, opinion pieces and activist manifestos. The arguments in this mass of information exhibit a variable degree of scientific rigor and academic sincerity. One can find from well-meaning pieces which are careless about their sources, to those that reflect the bias of pre-existing interest.

Given the extent of the debate, the discussions range from acknowledging the phenomenon (is there an arms race or not?) to issuing specific recommendations to different countries on how to address it; some options advise not to lag behind and start shopping immediately, while others stake everything on the consolidation of regional integration, delaying much-needed technological modernizations to avoid causing suspicious reactions from the others.

This paper discusses an issue that cannot be avoided in any scientific analysis of the arms race phenomenon and its applicability to the regional context. This issue is related to the validity of the patterns generally adopted for measuring and comparison purposes by those who have discussed the matter. Finally, an alternative indicator will be proposed for national effort comparisons.

### What is an Arms Race?

According to a classical school of thought, the configuration of an arms race requires the concurrence of the following conditions:

- Two or more parties perceive each other as adversaries.
- Such parties are building up their arsenals at a fast pace.
- Each such party must structure its respective military stance on the basis of its counterpart's past, present and potential behaviour.<sup>1</sup>

An arsenal increase implies the acquisition of new weapons or the upgrade of existing ones. These operations should be reflected in the countries' defence expenditures.

### How much does Latin America spend on Defence?

Despite an overwhelming number of references, it is impossible to answer this question with any accuracy. Latin America still lacks an exhaustive official source measuring defence expenditures. Therefore, it is not possible to determine, in comparative terms and through a budget analysis, how much money each country invests in arms.<sup>2</sup>

There is an incomplete international register (UN Disarmament Department), there are series offering functional classifications of defence expenditures (IMF) and there are also databases developed by think tanks using definitions and methodological criteria of their own (SIPRI, IISS). Of course, each country also

<sup>1</sup> Colin S. Gray, “The Arms Race Phenomenon”. *World Politics*, Vol. 24, n°1 (1971).

<sup>2</sup> The OAS has, however, created an official source of information on arms transfers through the Inter-American Convention on Transparency in Conventional Weapon Acquisition, which was adopted in 1998 and entered into force in 2002. This Convention adopts, for the Hemisphere, the United Nations Register of Conventional Arms (1992) model, which is based on 7 categories: battle tanks, armored combat vehicles, large-caliber artillery systems, combat aircraft, attack helicopters, warships, missiles and missile launchers.

has national budget laws which disaggregate defence expenses by sector; this information is compiled by RESDAL in the present volume. In the case of these data, a bilateral measuring methodology has been proposed for the Chile-Argentina twosome (CEPAL). But, despite this wide variety of sources, the creation of an official regional register is still outstanding on the part of the OAS at inter-American level, and even more on the part of the UNASUR at South American level.

In the framework of the register kept by the United Nations, presentations are voluntary, in local currency, with no verification or aggregation required. The IMF's database (GFS) disaggregates the defence function, excludes training and medical assistance expenses, among other items, and can only be accessed by subscription. The same can be said of the IISS' annual report *Military Balance*. SIPRI offers open access but does not disaggregate expenditure components.

Notwithstanding the complexity in origin brought about by the choice of the source (which implies having available multiple data for the same year and country), a pyrotechnic use of the figures is frequently observed in the material available. The main variables being handled are the total expenses in international currency (at most, mention is made of their variations against the previous year), and their relative shares in the GDP.

In addition to these static divergences it should be considered that the processes for the procurement of a weapons system usually take from 3 to 5 years, from the administrative determination of the requirement up to its effective employment in operations. This situation requires more sophisticated analyses of expense time series, contemplating the dynamics of their processes and using both transversal and longitudinal data, in order to verify in practical terms some pompous weapon acquisition announcements.

In brief, with the present scattered and heterogeneous data and the type of statistical analysis applied, which is mostly transversal, it is impossible to state whether an arms race exists in Latin America or not. A data panel or time series analysis will have to be performed, which implies surveying various data on equipment investments from several countries over several years and empirically testing the action-reaction hypotheses. It should be borne in mind that a country may have internal motivations driving it to modernize its arsenal: global geopolitical aspirations, the availability of specific funds, the decision to employ the armed forces in non-military tasks, technological obsolescence and industrial leverage.

### **Spend a lot, spend little**

It has often been held that country *A* spends a lot on defence because the percentage of its GDP earmarked for this purpose doubles the amount assigned, also in relative terms, by its neighbour *B*. Leaving aside the fact that base asymmetries (different sizes) imply that *A* and *B* may reach military parity by assigning different amounts of their GDPs, it remains legitimate to start by questioning the relevance of the GDP as the denominator in the ratio. After all, the GDP only expresses the wealth generated by a country in a calendar year. It is the sum of the added value of all productive sectors (including the government) in a 12-month period and is a flow variable representing the national income strictly within that period. It obviously conditions the amount of the annual national budget and therefore the defence budget, but its usefulness does not go much further. Therefore, any conclusions drawn from this line of argument line should be considered as relative.

### **State Security perceived as Insurance**

It is clear that the overwhelming majority of Latin American constitutions have assigned to their defence systems the primary mission of protecting territorial integrity, and preserving resources (both natural and produced), which represent a stock variable of the country's wealth. It is necessary to think of studies allowing a correlation between defence expenditures and national wealth, which is ultimately the wealth that needs to be preserved.

Sharing with Thomas Scheetz the symbolic analogy of national defence as a sort of insurance for the State, we may think of the annual defence expenditure as the cost of an insurance policy, which in actuarial calculations is called "premium". Every premium is directly related to the insured capital. This means that, given a certain risk level, the higher the capital insured, the higher the premium.<sup>3</sup> The translation of this micro logic to the macro national dimension opens a road which remains largely unexplored in the defence expenditure debate, thereby introducing a different facet of the State Security concept.

In 2006, the World Bank published *Where is the Wealth of Nations?*, one of the most recent surveys on the estimation of global wealth and its components, where it assessed world wealth as at 2000. According to the

<sup>3</sup> The difference is that, while in the case of private assets, a more expensive insurance does not reduce the exposure to loss risks (at most, it increases the probability of full recovery), in the case of national wealth, a military instrument with higher capacities (and more expensive) would reduce the probability of "loss" occurrence by deploying a higher deterrent effect towards potential aggressors.



Table I. State Insurance Premium in Latin America

Country	National Tangible Wealth	Defence Expenditure	State Insurance Premium
	2000 US\$ billions	2008 –SIPRI-US\$ billions	
Argentina	1,054.8	2.8	0.26%
Bolivia	58.1	0.3	0.43%
Brazil	2,788.8	23.3	0.84%
Chile	329.0	6.0	1.82%
Colombia	483.0	9.1	1.88%
Costa Rica	64.3	0.0	0.00%
Dominican Rep.	74.3	0.3	0.38%
Ecuador	198.2	1.5	0.78%
El Salvador	31.2	0.1	0.38%
Guatemala	69.1	0.2	0.24%
Guyana	10.3	0.0	0.00%
Honduras	39.2	0.1	0.30%
Mexico	2,689.4	4.9	0.18%
Nicaragua	19.3	0.0	0.22%
Panama	45.9	0.0	0.00%
Paraguay	51.9	0.1	0.25%
Peru	237.0	1.4	0.58%
Suriname	9.2	0.0	0.00%
Uruguay	66.7	0.4	0.60%
Venezuela	987.4	4.3	0.44%
<b>TOTAL</b>	<b>9,307.1</b>	<b>54.9</b>	<b>0.59%</b>

Sources: World Bank, *Where is the Wealth of Nations? Measuring Capital for the 21st Century*, (Washington D.C.: The International Bank for Reconstruction and Development, 2006) and Stockholm International Peace Research Institute, "SIPRI Military Expenditure Database", SIPRI, <http://www.sipri.org/databases/milex>.

Table II. State Insurance Premium in G-8, China and India

Country	National Tangible Wealth	Defence Expenditure	State Insurance Premium
	2000 US\$ billions	2008 –SIPRI-US\$ billions	
United States	26,699.2	616.1	2.31%
Japan	19,255.2	46.3	0.24%
Germany	6,011.4	46.8	0.78%
Russia	4,775.7	58.3	1.22%
France	3,777.9	66.0	1.75%
United Kingdom	3,674.5	65.6	1.79%
Italy	3,266.5	38.9	1.19%
Canada	2,738.4	19.3	0.70%
<b>G-8 Total</b>	<b>70,198.8</b>	<b>957.3</b>	<b>1.36%</b>
China	6,539.2	86.2	1.32%
India	3,131.1	32.3	1.03%
<b>TOTAL</b>	<b>79,869.1</b>	<b>1,075.8</b>	<b>1.35%</b>

Sources: World Bank, *Where is the Wealth of Nations? Measuring Capital for the 21st Century*, (Washington D.C.: The International Bank for Reconstruction and Development, 2006) and Stockholm International Peace Research Institute, "SIPRI Military Expenditure Database", SIPRI, <http://www.sipri.org/databases/milex>.

proposed methodology, wealth is based on a tangible component and an intangible component. Tangible wealth in turn comprises Natural Capital (energy resources, mineral assets, timber resources, pastureland, cropland and protected areas) and Produced Capital (urban land, machinery and structures). Intangible wealth includes manpower, human capital, social capital and other factors such as institutional quality.

Table I shows the tangible wealth of the 20 countries comprised in the sample and their defence expenditures (SIPRI, 2008), and introduces the State Insurance Premium as a quotient.<sup>4</sup> Table II shows the same variables for G-8 plus China and India, for comparison purposes.

The State insurance premium may be interpreted as reflecting the risk level that each country perceives in its context (defensive posture) or the power project it wishes to deploy (expansive posture).

Some preliminary conclusions that may be drawn from both tables are the following:

1. Latin American pays a regional premium lower than the premium paid by half the G-8 plus China and India.

2. Latin American countries whose premiums exceed the regional average have weighty endogenous factors influencing their defence expenditures (global geopolitical aspirations, equipment funds tied to commodities, internal armed conflicts, etc.). Mexico appears as a significant "free rider" of the US.

3. The US defence expenditure exceeds the aggregate military expenditures of the other G-8 countries plus China, India and Latin America, and its relative premium is 4 times that of Latin America.

4. G-8 countries plus China and India whose premiums are above the group average are permanent members of the United Nations Security Council (Russia and China are very close to it).

Returning to the question raised in the title of this paper, the existence of an arms race in Latin America has not been scientifically proven. Analyses are conditioned by the dispersed and heterogeneous characteristics of the sources. For this reason, it is advisable to urge the OAS and UNASUR to implement an institutional regional source allowing the performance of unequivocal evaluations which will contribute to transparency and trust-building in the region.

<sup>4</sup> It is of course admitted that the variables are being compared at different times, and that national tangible wealth magnitudes per country must have changed significantly as a result of the post-2000 commodity boom and the growth of China and India, among other factors.

Chapter 4:

# Political Definitions

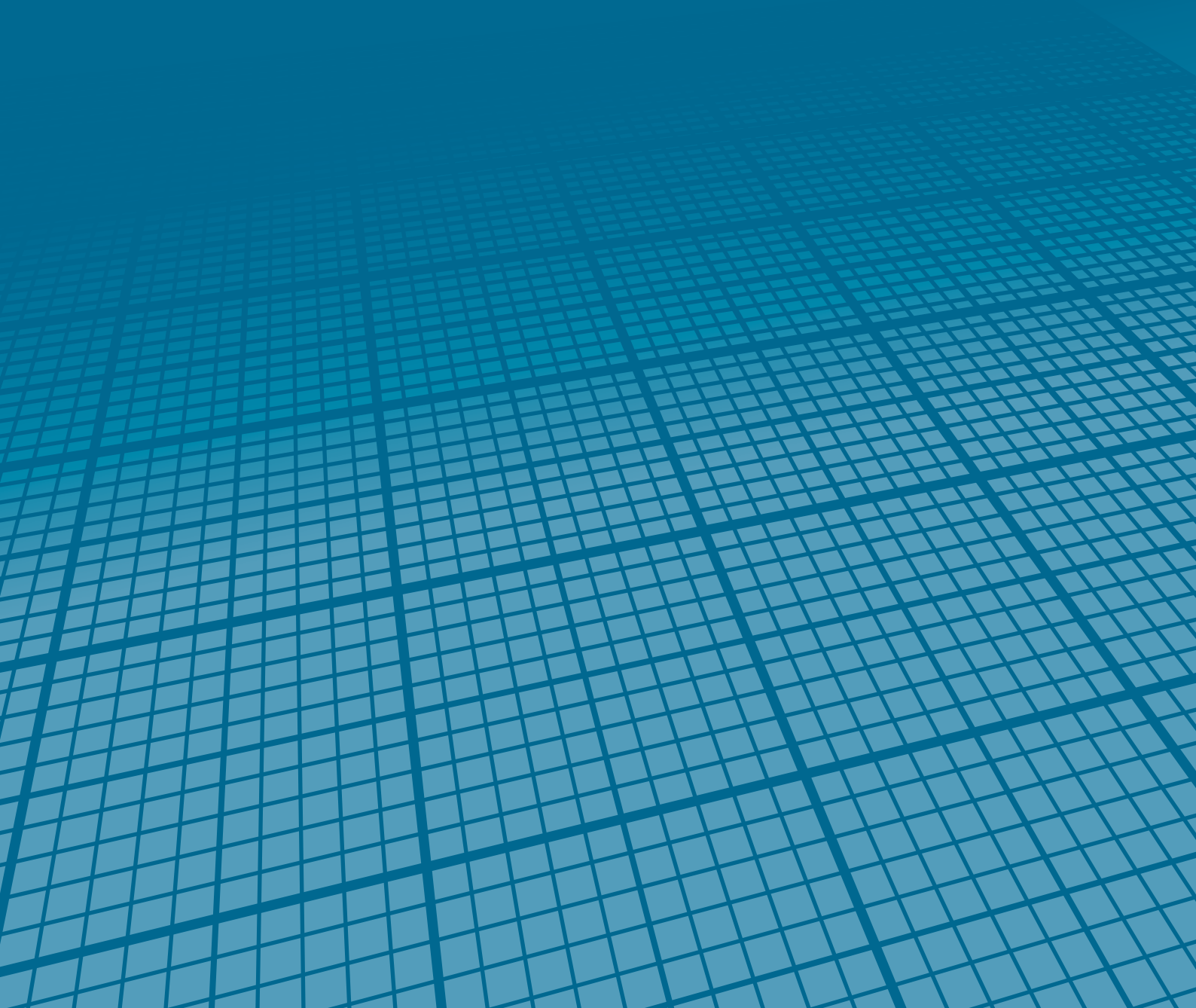



### Security and Defence Concepts

Country	Defence	Security
<b>Argentina</b>	National defence is the integration and coordinated action of all the Nation's forces to solve conflicts requiring the use of the Armed Forces in a deterrent or active way in order to face external aggression. Its purpose is to guarantee the sovereignty and independence of the Argentine Nation on a permanent basis, as well as its territorial integrity and capacity for self-determination, and to protect the life and freedom of its inhabitants. <i>(Ley de defensa nacional, N° 23.554 – 1988/05/05, Sec. 2)</i>	Internal security is an actual state of rule-of-law in which are safeguarded the freedom, life and assets of the country's inhabitants, their rights and guarantees, and the full strength of the institutions of the national representative, republican and federal system, as established by the National Constitution. <i>(Ley de seguridad Interior, N° 24.059 - 1992/01/17, Sec. 2)</i>
<b>Bolivia</b>	Defence is a fundamental responsibility of the State, it is integrated, multi-faceted, dynamic, permanent and fully articulated with security and development, based on the close union of the civil-military society (people and Armed Forces) with its efforts directed to the protection of the State, the society and its interests. It implies active participation of the Armed Forces in integrated development, where this entity does not design or manage social policy but whose participation is indispensable for the operation of the State's social policies. The concept of defence encompasses the set of measures that the State employs to counter any external or internal aggression, in order to attain certain security conditions, knowing that it covers all of the country's activities and, therefore, it is not the exclusive task and responsibility of the Armed Forces, but of all organizations and physical and artificial persons. <i>(Bases para la Discusión de la Doctrina de Seguridad y Defensa del Estado Plurinacional de Bolivia, 2010)</i>	The concept of "Integrated Security" of the Plurinational State of Bolivia is attributed the following characteristics: - It is a political, economic, cultural, social, environmental and military condition. - It appears as a continuous and enduring process. - It has its own dynamics - It is born with the organization of the State. - It is closely related to the sovereignty and independence of the State. - It is based on the objectives and the interests of the State. - It is privileged in the sense that it is related to the preservation and survival of the State. - It is a fundamental condition to development <i>(Bases para la Discusión de la Doctrina de Seguridad y Defensa del Estado Plurinacional de Bolivia, 2010)</i>
<b>Brazil</b>	National defence is the set of State measures and actions focussed on the military sphere and aimed at defending the national territory, sovereignty and interests against threats mainly arising from potential or evident external sources. <i>(Política de Defensa Nacional)</i> The national defence strategy is inseparable from the national development strategy. It is the link between the concept and policy of national independence, on one hand, and the Armed Forces used to safeguard that independence, on the other. The basis for national defence is the identification of the Nation with its Armed Forces and, in turn, of the Armed Forces with the Nation. <i>(Estrategia Nacional de Defensa, 2008)</i>	In general, security is a condition which allows the country to maintain its sovereignty and territorial integrity and to further its national interests, free of pressure and threats of any nature, and guarantees to the citizens the exercise of their constitutional rights and duties. <i>(Política de Defensa Nacional, Decree N° 5.484 - 2005/07/01)</i>
<b>Chile</b>	National defence is the set of material, human and moral resources available to a nation to counteract the threats of an adversary willing to disrupt its national interests, in particular its sovereignty and territorial integrity. Its purpose is to attain an external security condition to enable the country to reach its objectives free from all external interference. Defence is a State's untransferable function. It contributes to the nation's security through the legitimate use of force, deterrence and international cooperation. <i>(Libro de la Defensa Nacional de Chile, 2010)</i>	Security consists in a desirable condition for the realization of the purposes of the State and the Nation, particularly those related to social and economic development. <i>(Libro de la Defensa Nacional de Chile, 2010)</i>
<b>Colombia</b>	The Consolidation of Democratic Security Policy is the national defence policy of Colombia for the 2006-2010 period. Its implementation principles are: achieve security and peace, perform duties legally, have a permanent presence, promote security as a guarantee for the work of justice, be flexible and adaptable, apply coordination among the Forces and with other State agencies. The strategic objectives are set out as follows: - Consolidate territorial control and strengthen the rule of law in all the national territory. - Protect the inhabitants, by keeping the strategic initiative against all threats to their security. - Increase the cost of engaging in drug-trafficking activities. - Keep a legitimate, modern and effective public forces, supported by the trust and backing of the people. - Maintain the decreasing trend in all crime indicators in all urban centres of the country. <i>(Política de Consolidación de la Seguridad Democrática, 2007)</i>	
<b>Cuba</b>	The Republic of Cuba bases its national defence policy in its aspiration for a dignified, true and valid peace for all States, founded on the respect for independence, sovereignty and self-determination of its people, as well as its commitment towards all other principles consecrated in the United Nations Charter and other international treaties the country is a party to. The Cuban military doctrine is the set of ideas and concepts, adopted on a scientific basis, by the State, on the essence, objectives, character, special nature and consequences of war; the preparation of the country for the successful conduct of war in order to avert it; and the methods for its execution and conduct to face a military aggression. Such doctrine is based on the concept of War of All the People. This defensive strategic concept, which summarizes the historical experience accumulated by the nation, is based on the deployment of the territorial defensive system to support its military power, and in the wider use of all the forces and resources of society and the State. <i>(Ley de defensa nacional, N° 75 – 1994/12/21, Preamble and Sec. 3)</i>	
<b>Dominican Republic</b>	For the development of security and defence policy at the national level, the following directives have been established: • Definition and identification of national objectives. • The approval of a National Security Act. • Modification of the Organic Law of the Armed Forces. • Publication of the White Book of Defence and the Manual of the Joint Doctrine of the Armed Forces. • Creation of the National Intelligence System. • Strengthening of the Permanent Committee of Reform and Modernization of the Armed Forces.	• Definition of the Armed Forces model. • Foster Armed Forces transformation. • Develop a new institutionalization and professionalization model. • Reform the military career. • Improve equipment. • Foster research, development and innovation. <i>(Directiva de Seguridad y Defensa Nacional, Decree N° 189-07 - 2007/04/03, Sec. 3)</i>
<b>Ecuador</b>	National defence is the heritage of all the people, and not solely of the military sphere. It is a public asset that needs to be built by society based on the principles of joint responsibility among the various sectors of society, under the State's leadership, focused on equality in the internal structure of the Armed Forces and in society as a whole. It responds to a comprehensive vision of peace building, security and development. The current Defence Policy is based on preserving the nation's sovereignty and territorial integrity, as well as on the promotion of regional integration and cooperative security among peoples and States. <i>(Agenda Política de la Defensa Nacional, 2008)</i>	Public security will be integral for human security for all Ecuador's inhabitants, communities, peoples, nationalities, collective groups, and society as a whole, state and private institutions, and shall entail shared actions in prevention, protection, and defence and punishment. Thus, risks and threats to the peaceful coexistence, security of its people and State and the country's development can be averted; protecting citizen coexistence and security, defending sovereignty and territorial integrity; punishing actions and lack thereof that may threaten public and national security. <i>(Ley de seguridad pública y del Estado, N° 35 – 2009/09/28, Art. 4)</i> Integral security shall be understood as the comprehensive view of hu-

Country	Defence	Security
Ecuador		man security, cooperative security and other multidimensional integral visions aimed at safeguarding the interests of the country's internal and external security, placing the human being at the heart of the security focus. It includes the State and civil society's set of actions that can, in a harmonious and interdisciplinary way, revolutionize security from a comprehensive and multidimensional perspective in order to protect and guarantee the principles related to human rights, governance, strengthening democracy, liberties, people's right to a good standard of living, reciprocal assistance and security with solidarity among the peoples, promoting Latin American integration, South-South relations and global security. ( <i>Agenda Nacional de Seguridad Interna y Externa, 2008</i> )
El Salvador	National defence: set of resources and activities that the State develops on a permanent basis, in all fields of action, through coordinated actions, in order to face threats to national sovereignty and integrity of the territory. ( <i>Ley de defensa nacional, DL N° 948, 2002/10/03, Sec. 4</i> )	National security: set of permanent actions promoted by the State in order to create conditions to overcome international conflicts, disturbances of public order, natural catastrophes and those vulnerabilities which may limit national development and endanger the achievement of national goals. ( <i>Ley de defensa nacional, DL N° 948, 2002/10/03, Sec. 4</i> )
Guatemala	The external security field belongs to the defence of interdependency and sovereignty, territorial integrity, peace, and the maintenance and strengthening of international relations. It works under the responsibility of the President through the ministries of Foreign Affairs and Defence. In the functioning and coordination of the external security field, the content of the international treaties and agreements to which Guatemala belongs shall be considered. Regarding foreign policy, it is aimed at preventing and counteracting threats and risks which could affect politically the country and are produced by external factors. As regards national defence, it develops the Nation's defence policy and guarantees the calling up and mobilization of civil defence. ( <i>Ley marco del sistema nacional de seguridad, N° 18-2008, 2008/04/15, Sec. 20</i> )	The internal security field includes, in a preventive and direct manner, the set of risks and threats from organized crime and common delinquency, in defence of the democratic State under the rule of law. It works under the responsibility of the President through the Ministry of Government. ( <i>Ley marco del sistema nacional de seguridad, N° 18-2008, 2008/04/15, Sec. 19</i> )
Honduras	Defence is defined as a set of actions and capacities aimed at guaranteeing the territorial integrity, sovereignty and independence of the country. National defence is focussed on preventing and neutralizing external threats which jeopardize national interests. ( <i>Libro de la Defensa Nacional, 2005</i> )	Security is a multidimensional concept which encompasses several aspects of the national reality. It is a guarantee for development as long as it generates the adequate conditions for productive investment and the creation of employment. Security is responsibility of the State and it creates co-responsibility, participation and public involvement of society in defence and the maintenance of mutual security. ( <i>Libro de la Defensa Nacional, 2005</i> )
Mexico	In accordance with the provisions of the [National Security] Act, Art. 3, national security shall be understood as the immediate and direct actions destined to maintain the integrity, stability and permanence of the Mexican State, involving: I. The protection of the Mexican nation against threats and risks faced by our country; II. The preservation of national sovereignty and independence and territorial defence; III. The maintenance of constitutional order and the strengthening of the government's democratic institutions; IV. The upholding of the unity of integral components of the Federation, referred to in article 43 of the Political Constitution of the United Mexican States; V. The legitimate defence of the Mexican State with respect to other States or subjects of International Law, and VI. The preservation of democracy, based on the economic, social and political development of the country and its people. ( <i>Programa para la Seguridad Nacional, 2009-2012</i> )	
Nicaragua	National defence is the means whose goal is to guarantee the security of the State, through the execution of a set of measures and actions aimed at preventing or prevailing over threats and risks. This implies that national defence is the capacity of the State to provide protection to its national interests and goals, by having all moral and material powers and forces of the Nation available and working in coordinated action. ( <i>Libro de la Defensa Nacional de Nicaragua, 2005</i> )	National security is a permanent condition of sovereignty, independence, territorial integrity, peace and social justice, which in the institutional framework of a social state of laws, provides the Nation with the necessary guarantees for the preservation of its interests and national objectives, against any threat, risk or aggression, as well as the exercise of individual freedoms and political rights, in accordance with the law. Although in itself it does not constitute a purpose, national security is a generic objective of the State which involves all of the forces of the Nation, expressed in national power. ( <i>Libro de la Defensa Nacional de Nicaragua, 2005</i> )
Paraguay	National defence is the system of policies, procedures and actions exclusively developed by the State in order to fight any form of external aggression that could jeopardize the sovereignty, the independence and the territorial integrity of the Republic, or the constitutional, democratic order in force. ( <i>Ley de defensa nacional y de seguridad interna, N° 1.337 - 1999/04/14, Sec. 2</i> )	Internal security is the state of affairs in which public order is safeguarded, as well as the life, freedom and rights of people and entities, as well as their assets, in a framework of the full functioning of the institutions established in the National Constitution. ( <i>Ley de defensa nacional y de seguridad interna, N° 1.337 - 1999/04/14, Sec. 37</i> )
Peru	The national defence and security system is the set of interrelated elements of the State whose functions are aimed at guaranteeing national security by means of the conception, planning, management, preparation, execution and oversight of national defence. ( <i>Ley del sistema de seguridad y defensa nacional, N° 28.478 - 2005/03/23, Sec. 3</i> )	Security is the situation in which the State has guaranteed its independence, sovereignty and integrity, as well as the inhabitants their fundamental rights established in the Constitution. This situation contributes to the consolidation of peace, integral development and social justice, based on democratic values and respect for human rights. ( <i>Libro de la Defensa Nacional, 2005</i> )
Uruguay	National defence refers to the set of civil and military activities aimed at preserving our country's sovereignty and independence, protecting its territorial integrity and strategic resources, as well as the peace of the Republic, within the framework of the law and the Constitution; contributing to create the conditions necessary for the present and future social well-being of the people. National defence constitutes both a right and an obligation of the citizens. It is a public asset, thus a vital, permanent, untransferable and integral responsibility of the State. ( <i>Ley marco de defensa nacional, N°18.650 - 2010/03/08, Sec. 1 and 2</i> )	National security is the condition when the national assets of all kinds and the development process towards national objectives are safeguarded against internal and external interference or aggression. ( <i>Ley orgánica de las Fuerzas Armadas, N° 14.157 - 1974/03/05; last amendment: Law N° 18.198 - 2007/11/28, Sec. 4</i> )
Venezuela	Integral defence: the set of defence systems, methods, measures and actions, whatever their nature and intensity, actively formulated, coordinated and executed by the State, with the participation of public and private institutions and natural and legal persons, national or foreign, aimed at protecting independence, freedom, democracy, sovereignty, territorial integrity and the integral development of the Nation. ( <i>Ley orgánica de seguridad de la Nación, GO N° 37.594 - 2002/12/18, Sec. 3</i> )	Security of the Nation: It is founded on integral development and it is the condition, state or situation which guarantees the full exercise of the rights and guarantees in the economic, social, political, cultural, geographical, environmental and military areas of the constitutional principles and values of the inhabitants, the institutions and each one of the persons who are part of the State and the society, with a generational approach, within a democratic, participatory and proactive system, free of threats to its survival, sovereignty and the integrity of its territory and other geographical spaces. ( <i>Ley orgánica de seguridad de la Nación, GO N° 37.594 - 2002/12/18, Sec. 3</i> )

Source: Compilation based on the legislation and documents mentioned above.



### Constitutional Missions of the Armed Forces

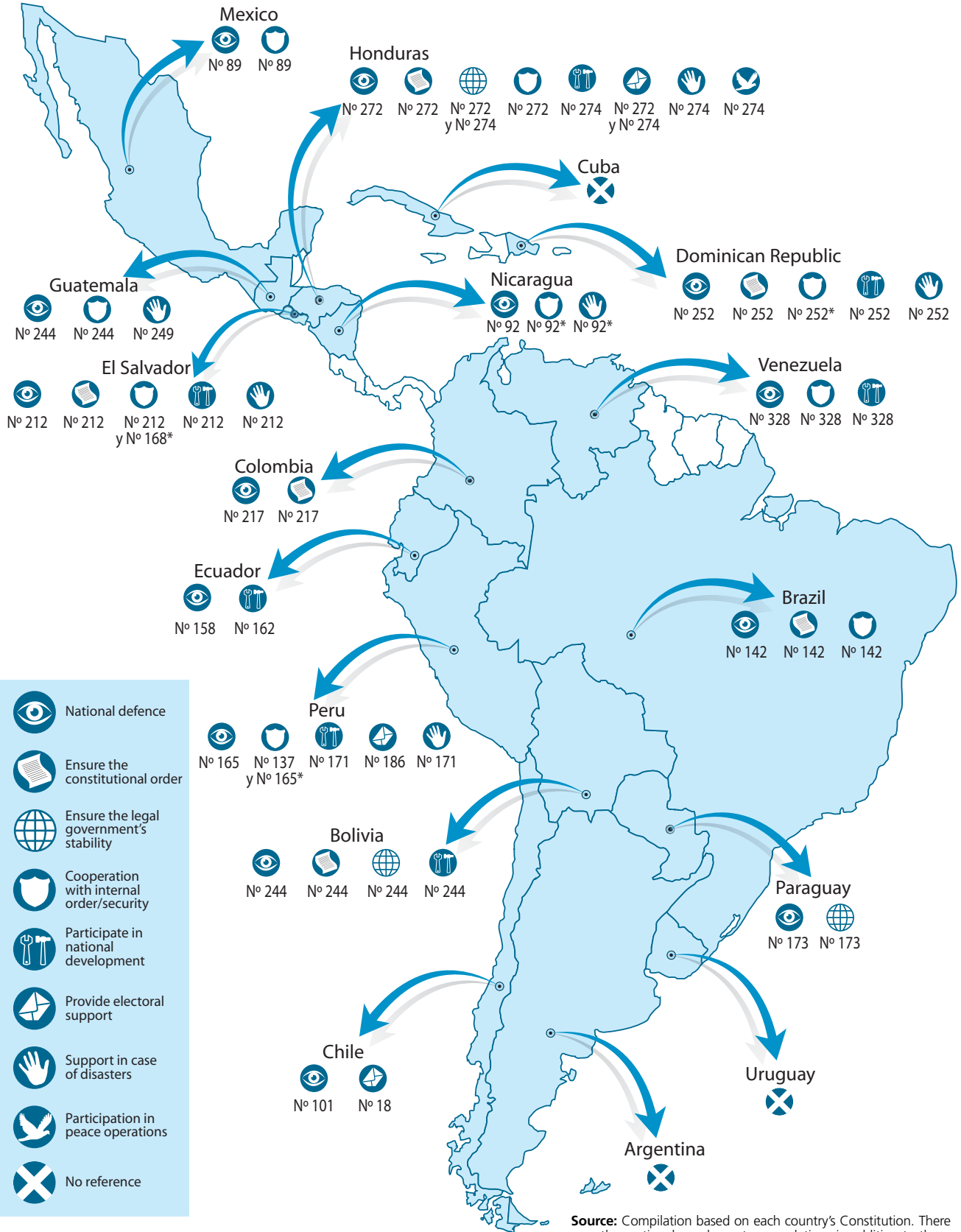

- National defence
- Ensure the constitutional order
- Ensure the legal government's stability
- Cooperation with internal order/security
- Participate in national development
- Provide electoral support
- Support in case of disasters
- Participation in peace operations
- No reference

\*Only in exceptional cases.

Source: Compilation based on each country's Constitution. There are other national supplementary regulations in addition to those included in this chart regarding the Armed Forces missions. For further information, refer to section "Countries" of this publication.

## Additional References - Legislation\*

Country	Guarantee of constitutional order / stability of legal government	Cooperation in internal order / security**	National development / environment	Electoral support	Support in the event of disaster	Participation in peace operations
Argentina						
Bolivia						
Brazil						
Chile					****	
Colombia						
Cuba						
Dominican Rep.						
Ecuador					****	
El Salvador						
Guatemala						
Honduras						
Mexico						
Nicaragua						
Paraguay						
Peru						
Uruguay		***	***	***	***	
Venezuela						

\* In addition to the defence of the sovereignty.

\*\* Argentina, Chile, Ecuador and Paraguay only under state of exception. Uruguay see next note.

\*\*\* In times of peace and with the explicit authorization of the National Defence Ministry, they may render services or cooperate with activities required on account of their specialization, social relevance or public convenience and without this being to the detriment of their fundamental mission (*Ley marco de defensa nacional*, Sec. 20).

\*\*\*\* Under state of emergency or disaster.

**Guarantee of constitutional order / stability of the legal government:**

- Guarantee the institutional order at the Republic (*Ley orgánica constitucional de las Fuerzas Armadas*, Sec. 1 – Chile).
- Guarantee the legal and democratic order of the social rule of law (*Ley orgánica de defensa nacional*, Sec. 2 – Ecuador).
- Cooperate in the maintenance of the State's constitutional order (*Ley orgánica de la Armada de México*, Sec. 2 – Mexico).
- Defend the legally instituted authorities (*Ley de organización general de las Fuerzas Armadas de la Nación*, Sec. 6 – Paraguay).

**Cooperation in internal order/ security:**

- Cooperate, if necessary, to the maintenance of public order, upon request of the Executive Branch and according to the Political Constitution of the State (*Ley orgánica de las Fuerzas Armadas*, Sec. 6, sub. G – Bolivia).
- Military assistance when the National Police cannot, on its own, contain severe disorders or face a disaster or public calamity (Decree 1,512, Sec. 79 – Colombia).
- The President of the State Council may decide the use of the armed forces to maintain internal order and protect the citizenry, even though a state of emergency has not been declared (*Ley de la defensa nacional*, Sec. 35 – Cuba).

**Participation in national development / environment protection:**

- Cooperate with national development as subsidiary function (*Ley complementaria 136*, Sec. 16 – Brazil).
- Take care over the whole national territory of the protection and defence of the environment and renewable natural resources (*Ley por la cual se organiza el Sistema Nacional Ambiental*, Sec. 103 – Colombia).
- Possessing a structure that allows the use of its members in activities contributing to the country's economic and social development and environment protection (*Ley de la defensa nacional*, Sec. 34 – Cuba).
- Perform civil actions and social work fostering the country's development (*Ley orgánica del Ejército y Fuerza Aérea*, Sec. 1 – Mexico).
- Cooperate in the performance of work contributing to the country's development. Contribute to national resource preservation and renewal, to the improvement of the environment and ecological balance and other strategic plans established by the President (*Código de organización, jurisdicción y previsión social militar*, Sec. 2, sub. 7 – Nicaragua).

**Support to elections:**

- Contribute, support, take care and supervise the Election Power facilities and assets (*Ley orgánica de la Fuerza Armada Nacional Bolivariana*, Sec. 42, sub. 6 – Venezuela).

**Support in the event of disaster:**

- Operations supporting the national community or friendly countries (*Ley de reestructuración de las Fuerzas Armadas*, Sec. 6 – Argentina).
- Cooperate with civil defence (*Ley complementaria 136*, Sec. 16 – Brazil).
- The President of the State Council may decide the use of the armed institutions to face and remove the consequences of natural disasters or other types of disasters (*Ley de la defensa nacional*, Sec. 35 – Cuba).
- Assist the population in cases and zones of disaster or emergency (*Ley orgánica de la Armada*, Sec. 2, sub. VIII). In the event of disaster, help in the maintenance of public order, protection to people and their property and reconstruction of areas affected (*Ley orgánica del Ejército y Fuerza Aérea*, Sec. 1 – Mexico).
- Cooperate in civil defence (*Ley de organización general de las Fuerzas Armadas*, Sec. 7, sub. D – Paraguay).
- Participate in civil protection operations in disaster situations. Support communities in case of disaster, public calamities and similar events (*Ley orgánica de la Fuerza Armada Nacional Bolivariana*, Sec. 4, sub. 6 and 15; Sec. 42, sub. 6 – Venezuela).

**Participation in peace operations:**

- Operations sponsored by the United Nations (*Ley de reestructuración de las Fuerzas Armadas*, Sec. 6 – Argentina).
- The employment of the Armed Forces in peace operations is a responsibility of the President (*Ley complementaria 136*, Sec. 15 – Brazil).
- Departure of national troops from the territory of the Republic in order to participate in peace operations organized under the Charter of the United Nations (*Ley que establece normas para la participación de tropas chilenas en operaciones de paz*, Sec. 7 – Chile).
- They may participate in peace keeping and humanitarian assistance operations according to the country's foreign policy and United Nations' requirements (*Ley orgánica de defensa nacional*, Sec. 16, sub. O – Ecuador).
- Paraguay may participate with its military institutions in peace missions promoted by international organizations of which it is member (*Ley de defensa nacional y seguridad interna*, Sec. 35 – Paraguay).
- Missions abroad that are not directly related to the Republic's defence shall be promoted by international organizations which the State is part of (*Ley marco de defensa nacional*, Sec. 21 and 22 – Uruguay).
- Participate in peace missions (*Ley orgánica de la Fuerza Armada Nacional Bolivariana*, Sec. 4, sub. 5 – Venezuela).

**Source:** Compilation based on the legislation mentioned. Reference is made to the missions specifically mentioned in the legislation regardless of those referring to subjects referred to in constitutional mandates; this description does not purport to be complete and encompassing the whole set of the missions they are supposed to have.





## Annual Reports on Ministerial Management

Country	Name	Published by
Argentina	<i>Memoria Detallada del Estado de la Nación</i>	Minister's Chief of Staff.
Bolivia	<i>Memoria Institucional</i>	Ministry of Defence.
Brazil	<i>Relatório de Avaliação</i>	Ministry of Defence.
Chile	<i>Cuenta Pública</i>	Government of Chile.
Colombia	<i>Memorias al Congreso de la República</i>	Ministry of National Defence.
Cuba	n/a	-----
Dominican Republic	<i>Memoria Anual</i>	Ministry of the Armed Forces.
Ecuador	<i>Informe de Gestión</i>	Ministry of National Defence.
El Salvador	<i>Memoria de Labores</i>	Ministry of National Defence.
Guatemala	<i>Memoria de Actividades</i>	Ministry of Defence.
Honduras	<i>Evaluación Fiscal Financiera</i>	Secretariat of National Defence.
Mexico	<i>Informe de Labores</i>	Secretariat of National Defence. Secretariat of the Navy.
Nicaragua	<i>Memoria Anual</i>	Army of Nicaragua.
Paraguay	<i>Informe del Gobierno Nacional</i>	Presidency of the Republic.
Peru	n/a	-----
Uruguay	<i>Memoria Anual del Ejercicio</i>	Presidency of the Nation.
Venezuela	<i>Memoria y Cuenta</i>	Ministry of the People's Power for Defence.

n/a: no available data.

Source: Compilation based on the information provided by the institutions mentioned above.

## Policy Documents

Country	Document
Argentina*	<i>Libro Blanco de la Defensa Nacional 1999. Revisión de la Defensa 2001. Directiva de Política de Defensa Nacional 2009.</i>
Bolivia	<i>Libro Blanco de la Defensa 2004. Bases para la Discusión de la Doctrina de Seguridad y Defensa del Estado Plurinacional de Bolivia 2010.</i>
Brazil	<i>Política de Defensa Nacional 1996 y 2005. Estrategia Nacional de Defensa 2008.</i>
Chile	<i>Libro de la Defensa Nacional de Chile 1997, 2002 y 2010.</i>
Colombia	<i>Política de Defensa y Seguridad Democrática 2003. Política de Consolidación de la Seguridad Democrática 2007.</i>
Dominican Republic	<i>Directiva de Seguridad y Defensa Nacional 2007.</i>
Ecuador	<i>Política de la Defensa Nacional del Ecuador 2002 y 2006. Agenda Política de la Defensa Nacional 2008.</i>
El Salvador	<i>Libro de la Defensa Nacional 2006.</i>
Guatemala	<i>Libro de la Defensa Nacional de la República de Guatemala 2003. Política de la Defensa Nacional 2005.</i>
Honduras	<i>Libro de la Defensa Nacional 2005.</i>
Mexico	<i>Libro del Ejército y Fuerza Aérea Mexicanos 2005.</i>
Nicaragua	<i>Libro de la Defensa Nacional de Nicaragua 2005.</i>
Paraguay	<i>Política de Defensa Nacional de la República del Paraguay 1999.</i>
Peru	<i>Libro Blanco de la Defensa Nacional del Perú 2005.</i>
Uruguay	<i>Bases Para una Política de Defensa Nacional 1999.</i>

\* At the time of writing, Argentina was in the process of elaborating its 2010 Defence White Paper (Libro Blanco de la Defensa 2010).

Source: Compilation based on the above mentioned documents.

### Transparency Measures

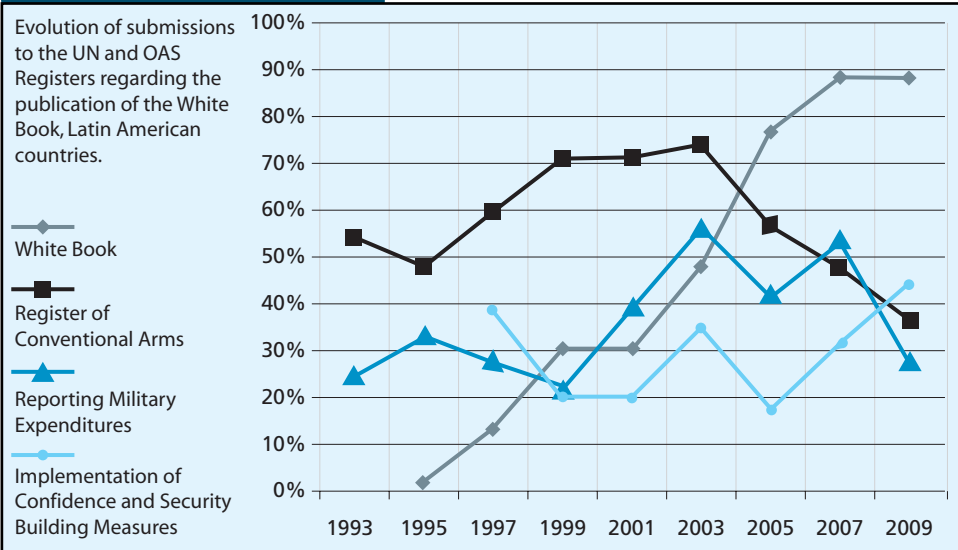

**Source:** Compilation based on White Papers (also referred to as White Books) and national defence documents of each country along with reports submitted by the States to the United Nations Register of Conventional Arms and the United Nations Instrument for Reporting Military Expenditures from 1992 to 2010 and reports submitted by States to the OAS on the Implementation of Confidence and Security-Building Measures in the 1997-2010 period.

**Register/Instrument:** Average number of reports submitted in each period (for the calculation of reports submitted to the OAS, all countries considered in this publication, with the exception of Cuba, have been included) White Books: cumulative frequency of countries which published White Books.

### Political Participation of Military Members

Country	Can they vote?		Can they be candidates for Elections?	
	Active	Retired	Active	Retired
Argentina	Yes	Yes	No	Yes
Bolivia	Yes	Yes	No	Yes <sup>(1)</sup>
Brazil	Yes	Yes	No <sup>(2)</sup>	Yes
Chile	Yes	Yes	No	Yes <sup>(3)</sup>
Colombia	No	Yes	No	Yes <sup>(3)</sup>
Cuba	Yes	Yes	Yes	Yes
Dominican Republic	No	Yes	No <sup>(4)</sup>	Yes <sup>(4)</sup>
Ecuador	Yes	Yes	No	Yes
El Salvador	No	Yes	No	Yes <sup>(5)</sup>
Guatemala	No	Yes	No	Yes <sup>(6)</sup>
Honduras	No	Yes	Yes <sup>(7)</sup>	Yes
Mexico	Yes	Yes	Yes <sup>(8)</sup>	Yes
Nicaragua	Yes	Yes	No	Yes <sup>(3)</sup>
Paraguay	Yes	Yes	No	Yes
Peru	Yes	Yes	No	Yes
Uruguay	Yes	Yes	No <sup>(9)</sup>	Yes <sup>(10)</sup>
Venezuela	Yes	Yes	No	Yes

- (1) In order to hold a public office, officers must resign at least three months before Election Day (Political Constitution, Art. 238).
- (2) With less than ten years of service, the individual shall retire; if he/she has had more than ten years of service, he/she shall be separated from full-time duty by his superior authority; if elected, he shall automatically be discharged.
- (3) One year after retiring.
- (4) Article 123 of the Constitution establishes as a requirement for President not to be in active military or police duty at least three years prior to presidential elections. Article 77 pertaining to the conditions required to become a congress member does not mention this requirement.
- (5) They can run for presidential election only three years after retirement.
- (6) Five years after retiring.
- (7) The Constitution mentions the possibility of running for elections in those cases not prohibited by law (Sec. 37), but it establishes that they cannot be elected Deputies (Sec. 199) or President (Sec.240).
- (8) The members of the military on active duty cannot be elected Deputies unless they shall definitely have resigned from their position ninety days prior to the election (Political Constitution, Sec. 55) or Senator (Political Constitution, Sec. 58), or six months in the case of President (Political Constitution, Sec. 82). The law indicates that in order to occupy a post subject to popular elections, the members of the armed forces shall request a special permit for that purpose.
- (9) Section 91 subsection 2 of the National Constitution establishes that "Members of the military who resign their position to enter legislative bodies, shall conserve their rank, but as long as their legislative responsibilities last they shall not be promoted. They shall be exempt from all military subordination. The time they remain performing legislative activities will not be counted for seniority for promotion". The Organic Decree-Law for the Armed Forces N° 14.157, in Section 98, says that the military status shall be suspended in the case of a "member of the military elected for a political position".
- (10) Section 77 subsection 4 of the National Constitution establishes that only the members of the military on active duty cannot perform political activities.

**Source:** Compilation based on national legislation. For more detail on such legislation refer to section "Countries" of this publication.



## Analysis

# The Hidden Appeal of Defence

### Rut Diamint

Faculty member of the Universidad Torcuato di Tella. Researcher of the CONICET.

During the so-called period of transition to democracy, a fairly consistent discussion emerged on the literature of civil-military relations. We will not delve into the details in this paper, but we would suggest reading the works by Felipe Agüero and Narcis Serra, both clearly summarizing the different arguments and concepts developed over those years.<sup>1</sup> All such works were not mere theoretical speculations but rather the expression of a political commitment to uphold the newly-es-

tablished democracies, giving way to a set of ideas that impacted the policymaking practices of defence ministers, foreign affairs ministers, members of congress, and the political leadership in general. A consensus was built on the irrevocable principles of any democracy.

This process of building a common episteme in Latin America and the Caribbean was reinforced by other driving forces whose aim was in line with the input from the academy: namely, to eradicate coups d'état, delegitimize military dictatorships, strengthen the flourishing democracies. Thus, we found international, national, local and private initiatives focussed on controlling the military. By way of example, the OAS undertook to disseminate the notions of confidence- and security-building measures, by formulating a digest of good practices intended to vacate of all meaning the arguments of conflict between neighbouring countries that had sustained Latin American militarism.

<sup>1</sup> Felipe Agüero, "Las fuerzas armadas en una época de transición: Perspectivas para el afianzamiento de la democracia en América Latina" in Rut Diamint ed., *Control civil y fuerzas armadas en las nuevas democracias latinoamericanas*, (Buenos Aires: Universidad Torcuato Di Tella-Nuevo Hacer, 1999); Narcis Serra, *La transición militar. Reflexiones en torno a la reforma democrática de las fuerzas armadas*, (Barcelona: Debate, 2008). See also Alfred Stepan, *Rethinking Military Politics: Brazil and the Southern Cone*, (Princeton, NJ: Princeton University Press, 1988); Samuel J. Fitch, *The Armed Forces and Democracy in Latin America*, (Baltimore-Londres: The Johns Hopkins University Press, 1998); and Alain Rouquié, *El Estado Militar en América Latina*, (Mexico: Siglo XXI Editores, 1984).

Shortly afterwards, in 1995, the US government proposed a dialogue mechanism between the Defence Ministers of the Hemisphere in the Williamsburg meeting. A commitment to elaborate Defence White Papers was made in those gatherings. Latin American governments gradually adopted these requirements of the Inter-American system. With the contribution of foundations, several Latin American organizations started to carry out activities to train civilian experts in defence.

Consequently, most of the governments in the hemisphere prepared a series of practices and instruments to respond to this democratic consensus. In a few cases—very few indeed—parliaments acquired a convincing role by turning the civilian control of the armed forces into an item on the political agenda in times of peace and relative stability in domestic economies. However, most unfortunately, this quick overview of changes in the military sphere must conclude, based on the evidence, that the effectiveness of such transformations is questionable. There seems to be a hidden appeal of defence that mesmerizes the boldest government officials and renders the most dexterous leaders unnerved.

Without falling into generalizations, as every country has gone through different circumstances, some particular facets can be discussed. For instance, a review of Defence White Papers (known as White Books in Spanish) and their content as compared with what is actually happening in the defence arena, could offer a measure of the gap between discourse and reality. Although a precise analysis of these comparisons exceeds the scope of this paper, based on accumulated experience on the matter, this author would suggest three reasons that could explain the failures in implementing what is promised in official documents.

#### **The “status quo” game**

Significant changes have taken place in the global arena between the early eighties and today. Recalling the main subjects of political science papers over the last two decades does not seem in point but, in a nutshell, regime changes, globalization, integration and uni-multipolarity have produced uncertainty. Making decisions in volatile contexts is risky. And it tends to be more dangerous in States that lack a tradition in devising medium- and long-term strategies. Consequently, the best thing to do is leave things as they are.

Government officials, given the impossibility to measure the effects—both domestic and international—of their potential decisions in the defence area, decided to

play it “as if.” This notion, taken from psychoanalysis, refers to the construction of superficial rationalizations that do not lead to true change. It is a mere intellectual fabrication that exhibits a tie to the past without taking root in reality.

The uncertainty characteristic of such an age of global changes and domestic mutations, and the likely cost to governance of advancing in defence sector reform in young democracies and social and economic urgencies led governments to content themselves with a setting that reinstated the conditions of the past without learning for the future. It was just “as if.” Ministries were reformed and new legislation was passed, without actually defining the activities, the methods and the organization of the armed forces. There were other concerns, too. And, who knows, those armed forces that had always been functional to political projects—although subsequently went beyond the desires of the leadership—may again serve the interests of certain groups. In sum, there were too many doubts for politicians to take the risk of building a different reality.

#### **The “compromise” game**

Associated with the above, there appeared another aspect that would underscore the distance between what was said and what was done. External demands, including those originated from the OAS or, in many occasions, direct pressure of the US, forced presidents to try and find quick solutions. It mattered little if they were correct or effective, presidents had to prove that they were performing on their promises; that they delivered. The president would order the minister; the minister, the officer in charge. This is an oversimplification of the process developed in that environment. Ministries had no personnel with the ability to put together a White Paper or a strategic directive, or a national defence council plan. No defence communities or strategic study and research organizations had developed in countries where there had been military dictatorships or where old arrangements had left military issues solely in the hands of the armed forces in exchange for their respect for the rules of civilian politics. For a fast—and superficial—solution officers were at hand.

At the same time, many civil society organizations—which had had an intense agenda in the fight against dictatorships—, once democratic regimes were established could not continue with their work related to the handling of the defence agenda in a republic. Their



expertise and their influence gradually diminished while many foundations that had financed them considered these matters closed and turned their attention to other social issues.

The subject became void and other bodies, very slowly, had to re-elaborate a new defence agenda, many times supported by government administrations. They had no experience in proposing and analyzing the stages involved in democratic consolidation. In spite of this, an expert community continued to grow. On the one hand, this allowed new actors to enter a legitimate space to study and understand defence. On the other hand, though, depending on government funding curtailed the self-determination and ability to criticise of those who were supposed to drive changes in the sector.

Compromise and mediocrity have been always associated in philosophical thinking, suggesting that accommodating is settling for a deceitful order. A rationale against compromise projects its purposes and motivates its agents to reach for the irresistible movement of progress. Ultimately, this was an accommodation that bore fruit in the short term, but compromised civilian conduct in the future.

### **The past condemns us**

There is an old saying that states that the armed forces are always getting ready to fight the previous war. This means they study strategy and tactics to learn and correct a past experience. Defence definitions seem to have suffered the same syndrome. White Papers and military-strategic directives have been prepared based on past scenarios. Deeply marked by the requirement to show civilian conduct and exhibit certain effectiveness in defence leadership, the documents prepared have responded to criteria and threats prevailing in preceding periods.

Overall, while the new regional integration dynamic was made explicit, military instruments, training provisions, vital interests, operational and communication levels reflected mid-20<sup>th</sup> century concepts. While there were allusions to globalization, the reference was to the geostrategic and geopolitical environment. The Ministry of Defence's role was discussed, but no policies were generated to strengthen it. The defence budget concept was replaced by one of defence investment, but the most thriving sectors of the economy remained excluded from production for defence. The Rule of Law was

talked about, but military justice continued to postpone the judgement of past crimes.

Defence innovation has always been a result of reaction. In some countries, the increasing public insecurity and forms of organized crime that defied police response capacity quickly led to the involvement of servicemen in public security. But there was no change in doctrine, training, or equipment. With the urgency of social demand, one had to get out into the street from one moment to the next, and, try, in vain, to fill in for State deficits.<sup>2</sup> In other countries, where political instability was more pronounced, the armed forces had to step in for the State, with social work, assistance and politization. Nor did this lead to a rethinking of the military instrument's role. Finally, in others, governments resorted to different agencies to cover up for their inefficiencies, organized more cooperative neighbourhoods only to find defence systems that were not functional for their objectives. But not even in those cases did they undertake a review of their functions, engage in an ample discussion of defence objectives, or was society invited to participate in Security Sector design.

The result is that, in general, never were the effectiveness, efficiency, efficacy or effectism sought after attained. We do not want the armed forces of the past, but the ones we have got in the present seem never to be able to show their usefulness: either because they fail to control organized crime; or they never end up as entirely reliable political allies; or they do not provide a service that is needed for state development.

Several democratic administrations have paved the way for the stigma of history to be overcome. Nobody is to pay the political cost of a complete defence system transformation at this time. All changes are cosmetic. Perhaps this inoperability can be attributed to the unfamiliarity of politicians with certain institutions, preferring to fortify their personal power. Or to a residual distrust among the countries in the region. It is best not to change too much because external conditions might change and the neighbouring country could once again become a threat. And if that happens, we still have our historical resources: the armed forces that defend the nation. That is the hidden appeal of defence that so much attracts when it is unknown, mysterious and maybe, beguilingly fatal.

<sup>2</sup> Avant, Deborah D., "Are the Reluctant Warriors Out of Control? Why the US Military is Averse to Responding to Post-Cold War Low-Level Threats," *Security Studies*, Vol. 6, No. 2, Winter 1996/97, p. 51-90.

Chapter 5:

# Hemispheric Relations

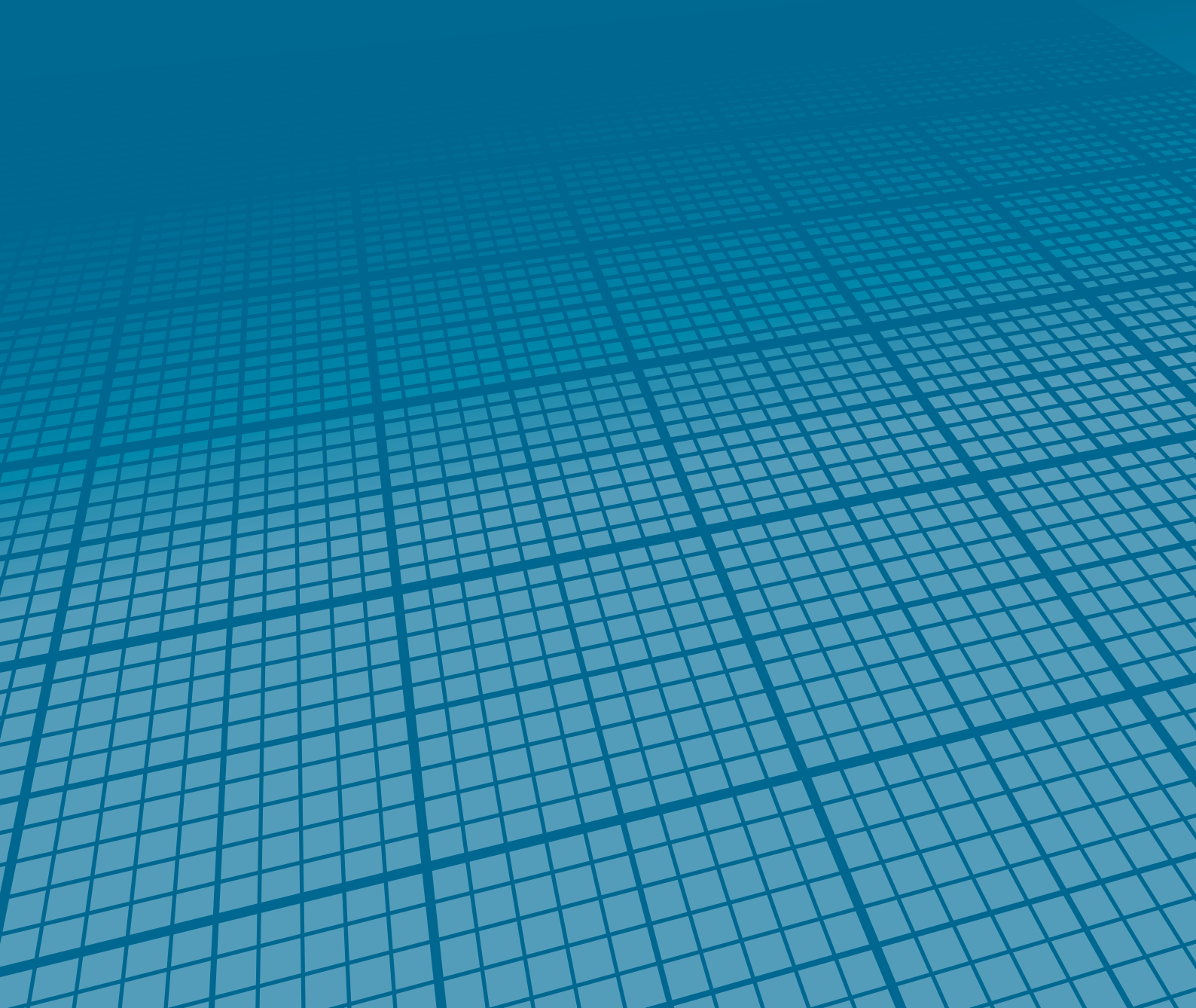



## Security and Defence Organizations and Initiatives

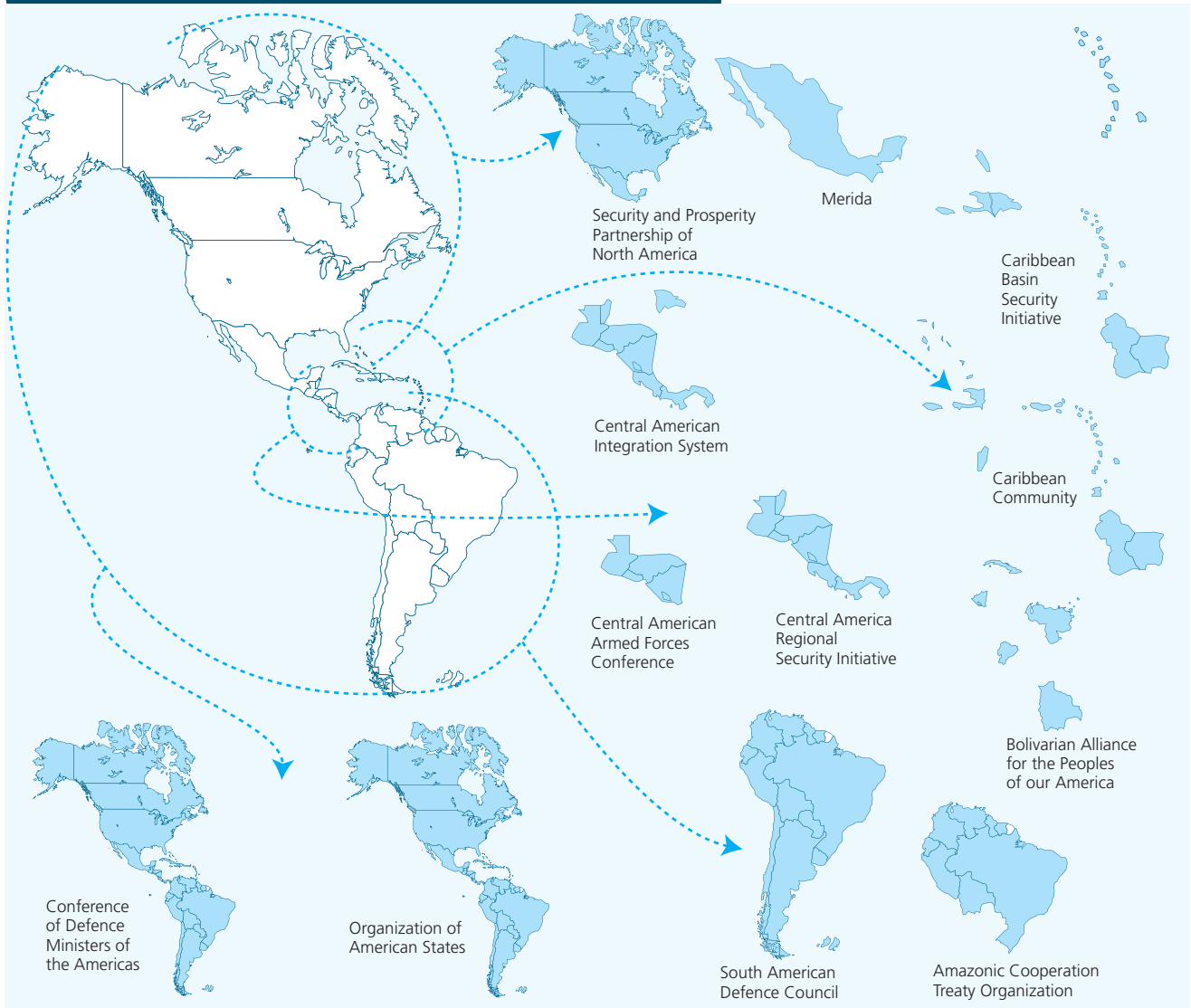

\*On July 3, 2009, Resolution 1962 expelling Cuba from the OAS was abolished (Cuba ratified it would not return to the OAS). On July 5, 2009 Honduras was suspended by the OAS as an active member (currently in the process of readmission).

**Source:** Compilation based on information provided by the mentioned organizations in their web sites.

### Organization of American States – Committee on Hemispheric Security (CHS)

In September 2008, the CHS decided to create a working group to unify the measures adopted in the Declarations of Santiago and San Salvador, and the Consensus of Miami. The work of such group resulted in a consolidated list of 36 confidence- and security- building measures to be reported by member countries every year, according to resolutions adopted by the OAS General Assembly (CP/CSH-1043/08). An inventory of such reports is communicated to the Inter-American Defence Board (IADB).

Meetings	
<b>Conventional Weapons</b> Inter-American Convention On Transparency In Conventional Weapons Acquisitions (1999).	Meeting of the States Parties in preparation for the Conference of the States Parties of the Inter-American Convention on Transparency In Conventional Weapons Acquisitions (2006, 2008, 2009).
	First Conference of the States Parties to the Inter-American Convention on Transparency in Conventional Weapons Acquisitions (2009).
<b>Confidence- and security- building measures</b> Declaration of Santiago (1995), San Salvador (1998), Consensus of Miami (2003).	Regional Conference on Confidence- and Security-Building Measures held in Santiago (1995), Regional Conference on Confidence- and Security-Building Measures held in San Salvador (1998).
	Meeting of Experts on Confidence- and Security-Building Measures in the Region (Miami, 2003).
	Forums on Confidence- and Security-Building Measures in the Region (2005, 2006, 2008).
<b>Hemispheric Security</b> Declaration on Security in the Americas (2003).	Special Conference on Security (2003).
	Meeting to examine the progress attained in the Implementation of the Declaration on Security in the Americas (2007).
	Celebration of the Declaration on Security in the Americas' Fifth Anniversary (2009).
	Follow-up of the Special Conference on Security (2010).

**Source:** Compilation based on documents of the OAS Committee on Hemispheric Security.

## Conference of Defence Ministers of the Americas (CDMA)

Since 1995, the CDMA has brought together 34 countries of the Hemisphere to meet every two years. In 2010, Cuba was invited to participate in the meeting. The CDMA seeks to advance reciprocal knowledge, analysis, debate and exchange of views and experiences on defence and security, as well as any other interaction mechanism to allow its fulfilment.

### Thematic Agendas

<b>I Williamsburg, 1995 (United States)</b>	Measures on transparency, military confidence and security improvement. Cooperation on defence measures. The Armed Forces in 21st century democracy.
<b>II Bariloche, 1996 (Argentina)</b>	New dimensions of international security. New roles. Institutional framework and relations between defence systems.
<b>III Cartagena, 1998 (Colombia)</b>	The hemispheric security system and its mechanisms for regional development. Complementary duties of the military forces in democratic societies. Hemispheric cooperation on counter-terrorism, counter-drugs, and combat of illegal trafficking in firearms, ammunitions and explosives.
<b>IV Manaus, 2000 (Brazil)</b>	Hemispheric security at the turn of the 21st century. Confidence-building in the American continent, current scenario and prospects for the next decade. Defence and development: regional cooperation possibilities
<b>V Santiago, 2002 (Chile)</b>	Regional security at the turn of the 21st century. Confidence-building in the Americas. Defence and society: regional cooperation possibilities.
<b>VI Quito, 2004 (Ecuador)</b>	The new architecture of hemispheric security. Confidence-building and security in the hemispheric security system. Defence, development and society: cooperation possibility.
<b>VII Managua, 2006 (Nicaragua)</b>	Hemispheric security system, subregional scenarios and regimes: strengthening cooperation and institutionality in the Americas. Confidence- and security-building measures and cooperation in multinational operations in the Americas. Modernization and transformation of defence institutions.
<b>VIII Banff, 2008 (Canada)</b>	Assistance in natural disasters. Assistance in major national or regional events. Peacekeeping operations.
<b>IX Santa Cruz, 2010 (Bolivia)</b>	Consolidation of peace, trust, security and cooperation in the Americas. Democracy, armed forces, security and society. Regional security and natural disasters. Strengthening hemispheric cooperation.

### Topics contained in Final Declarations

	Bariloche	Cartagena	Manaus	Santiago	Quito	Managua	Banff	Santa Cruz*
Condemning outlawed armed groups/terrorism.		↓	•	•	•	•	•	•
Civil society contribution.							↓	•
Inter-American Convention: transparency in conventional weapons.		↓	•	•	•	•	•	•
Cooperation on natural disasters.		↓	•	•		•	•	•
Defence: responsibility of all the society.			↓	•	•			
Humanitarian demining.			↓	•	•	•		•
HHRR/IHL education.		↓	•	•	•		•	•
Military education/training.							↓	•
Promotion of meetings and exchanges.		↓		•	•			
Civilian training/inclusion.			↓	•			•	•
Multiculturalism.								↓
Multidimensionality/new threats according to domestic laws.			↓	•	•	•	•	•
Non-proliferation.			↓	•	•	•	•	•
Peace operations.	↓	•	•	•	•	•	•	•
Gender perspective.				↓	•		•	•
Institutional modernization processes.					↓	•		•
Small arms and light weapons proliferation.		↓			•	•	•	•
Promotion of confidence-building measures.	↓	•	•	•	•	•	•	•
Protection of the cultural heritage.					↓			
Subregional realities/flexible architecture.			↓	•	•	•	•	•
Democracy-security-economy relation.				↓	•	•		
Budgetary transparency.			↓	•	•		•	•

#### Williamsburg Principles

- Mutual security rests on the preservation of democracy.
- Military and security forces play a critical role in supporting and defending the legitimate interests of sovereign democratic States.
- Subordination of the Armed Forces to the democratically controlled authority.
- Openness in the discussion of defence matters.
- Dispute resolution through negotiated settlements.
- Greater defence cooperation in support of security needs.

\*Draft Declaration as for September 2010

Source: Compilation based on the Conferences' Final Declarations. The main subjects addressed in each Declaration have been considered. Santa Cruz 2010: Draft Declaration





## Central America: Central American Armed Forces Conference (CFAC)

The CFAC is a specialized international body of military nature. It was created by the Presidents of El Salvador, Guatemala, Honduras and Nicaragua on November 12, 1997.

**Members:** El Salvador, Guatemala, Honduras, Nicaragua and Dominican Republic (joined in 2007).

**Observer countries:** Argentina, Belize, Brazil, Canada, Chile, Colombia, France, Germany, Russia, Spain, Taiwan, United Kingdom and United States.

**Mission:** to promote a permanent and systematic effort of cooperation, coordination and mutual support among the Armed Forces for the professional study of shared issues and provide a high level of defence against threats to democracy, peace and freedom. To contribute to security, as well as to the military development and integration in the region, in order to conduct humanitarian and peacekeeping operations.

### Organization

- Higher Council: decision-making body of the CFAC, integrated by the military officer of highest rank and hierarchy from each member country.
- Executive Committee: body in charge of providing advice, control and follow-up of decisions taken by the Higher Council. It is composed of the Chiefs of Joint Staff, or their equivalents, from member countries, and presided over by the host country.
- Pro-tempore General Secretariat: Conference administrative body; it serves on a two-year rotating basis. The Secretary General is a senior officer in the rank of Colonel, and Deputy Secretary General and representatives of the Armed Forces are members. The establishment and fulfillment of the Secretariat's tasks are the responsibility of the military institution from the host country. Each country sends a delegate to the host country, generally of the rank of Colonel.

**Pro-tempore Secretariat** for 2008-2009: El Salvador (the period was extended to November 2010).

### Main Programs developed by CAFC

- Education exchange for cadets, instructors and officers.
- Training exercises (virtual and practical).
- Confidence-building measures' annual programme.
- Peacekeeping Operations Unit.
- Humanitarian and Rescue Unit.
- Cooperation plan to prevent and combat terrorism and organized crime.
- Cooperation agreements with international institutions.
- Communication with SICA's Secretary General.
- Military health.
- Logistics.
- Human rights.
- Intelligence and operations.
- Civilian affairs.

### Humanitarian and Rescue Unit (UHR-CFAC)

It was created by the end of 1999 and started operating in 2000. It conducts humanitarian and rescue operations in any Central American country wherever a natural or anthropogenic disaster occurs, upon request of the President of the country afflicted by the disaster.

The Unit is made up of elements from each member country, which -once an operation is launched- operate under the operational command of the UHR-CFAC Commander of the host country. Operation costs are borne by each one of the countries that provide their assistance unit to the site.

Since its creation, it has provided assistance in:

- Fumigation, dengue outbreak. El Salvador, March, 2000.
- Laguna de Apoyo and Masaya earthquakes. Nicaragua, July, 2000.
- Earthquakes. El Salvador, January – February, 2001.
- "KEITH" hurricane, "MICHELLE" tropical storm. Nicaragua, September, 2000 and November, 2001.
- Fumigation, dengue outbreak. Honduras and Nicaragua, April, 2002.
- Tropical waves: 8, 13, 14 and 15. Nicaragua, 2002-2004.
- Beta hurricane. Nicaragua, 2005.
- "STAN" tropical storm. Guatemala and El Salvador, October, 2005.
- Llamatepec volcanic eruption. El Salvador, October, 2005.
- "FELIX" hurricane. Nicaragua, September – October, 2007.
- Rescue of a low pressure system. El Salvador, November, 2009.
- Earthquake. Haiti, January, 2010.

1991	Establishment of the SICA.
1992	
1993	
1994	
1995	Execution of the Framework Treaty on Democratic Security in Central America.
1996	
1997	Creation of CFAC.
1998	
1999	Creation of UHR – CFAC.
2000	Activation of UHR – CFAC.
2001	
2002	Integral cooperation plan to prevent and combat terrorism, organized crime and related activities.
2003	
2004	Activation of UOMP – CFAC.
2005	
2006	Creation of the Regional Peacekeeping Operations Command.

## Central American Integration System (SICA) – Defence Sub-Committee

The Defence Sub-Committee includes representatives of the Ministries of Defence of SICA countries that have their own armed forces and representatives of the SICA's General Secretariat. Panama and Costa Rica participate as observers. Although the Defence Sub-Committee and CFAC have not established any formal mechanism, bilateral meetings are often held.

The Sub-Committee is mainly responsible for regional security matters, including: demining, reasonable balance of forces, confidence-building measures annual programme, models for promotion of weapon/armament inventories, Central American information mechanism and security communication, studies on peaceful settlement of disputes, and crisis and peacekeeping.

The main working areas as of 2010 are:

- Natural disasters.
- Peace missions.
- Confidence-building measures.

It meets every six months at the location selected by the Pro-Tempore President.

**Sources:** *Acuerdo de Creación de la Conferencia de las Fuerzas Armadas Centroamericanas* (1997/11/12). *Manual de Políticas y Procedimientos de la Unidad Humanitaria y de Rescate UHR-CFAC* (XVI ROCS – 2005/12/16). *Memoria de Labores* (1998-2007). *Reglamento de la Conferencia de Fuerzas Armadas Centroamericanas* (Office of the President of the Republic of El Salvador, Executive Decree N° 79 – 2008/07/15). Web sites of the afore mentioned institutions. Defence Sub-Committee of SICA's Security Commission.

## UNASUR's South American Council

### Creation

December 2008. A Forum for Cooperation, Consultation and Coordination. It is attended by the Ministers of Defence of UNASUR member countries.

### Miembros

Argentina\*, Bolivia\*, Brazil, Colombia, Chile\*, Ecuador\*, Guyana\*, Paraguay, Peru\*, Suriname, Uruguay, Venezuela\*.

### Objectives

- Consolidate South America as a "peace zone".
- Build a South American identity in the area of defence, based on sub regional and national characteristics while contributing to the strengthening of Latin America and the Caribbean unity.
- Generate consensus to reinforce regional cooperation in the area of defence.

\*Countries that have ratified the UNASUR Treaty.

### Centre for Strategic Defence Studies (CDS)

Its Statute was approved at the II CDS Ordinary Meeting held on May 2010 and its permanent office is located in Buenos Aires, Argentina.

### Confidence- and Security-building Measures

The document was approved at the CDS II General Meeting in May 2010\*. Its main guidelines are:

- Information exchange and transparency (systems and defence spending).
- Intra- and extra-territorial activities.
- Security measures.
- Assurances.
- Compliance and verification.

(\*) Pending approval by the Council on Foreign Relations of UNASUR.

### Structure and Organization

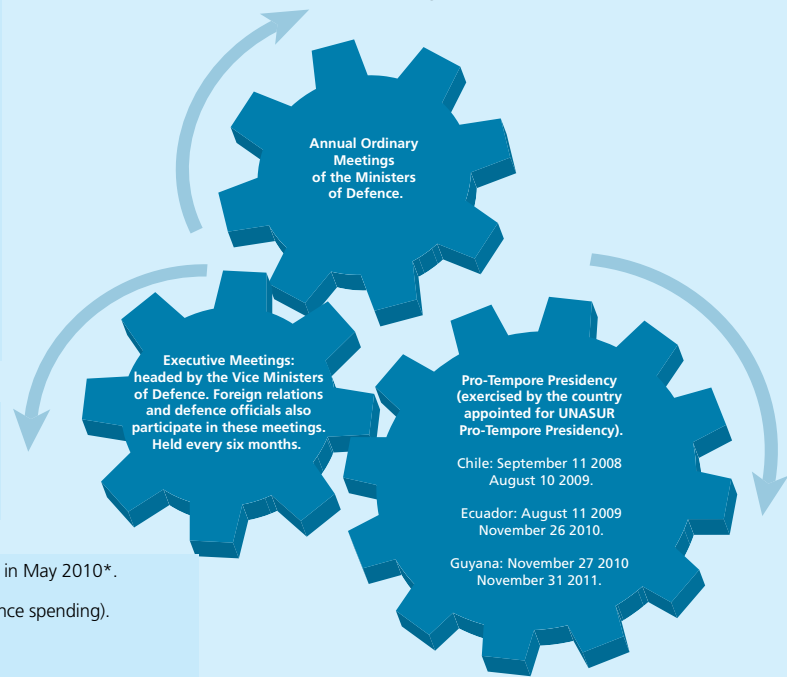

### Action Plan for 2010-2011

Defence Policy	R	JR	Military Cooperation, Humanitarian Actions	R	JR	Defence Industry and Technology	R	JR	Training and Education	R	JR	
Network for information exchange on defence policies.	Ec.	Sec. P-Te.	Seminar on crisis management challenges in peace operations.	Ec.		Consolidation of industry and technology's diagnosis.	Ec.		Database containing information on military institutions and education centres for civilian defence specialists.	Ec.	Ven.	
Methodology for measuring defence spending.	Chi.	Arg. Per. Ven. Ec.	Regional combined exercise on peacekeeping operations, modelling.	Arg.	Chi.	Panel on metrology, normalization and assessment of conformity, focusing on the defence sector.	Bra.	Ven.		Proposal of a South American defence education programme for the civilian representatives of CDS member states.	Arg.	Chi.
Seminar to advance in the identification of risk factors and threats, and the definition of conceptual approaches.	Ven.	Ec. Sur.	Exercise on natural disasters modelling.	Per.		Integrated system of information on industry and technology.	Ec.		Course on Defence (March, 2011) at the Brazilian War College for civilian and military personnel.		Bra.	
Mechanism to contribute to the coordination of joint positions in multilateral forums.	Per.	Chi.	Inventory of defence capabilities to support humanitarian action and proposals on employment mechanisms.	Bra.	Chile. Col. Per. Ven.	Annual agenda of fairs, seminars and other events.	Arg.			Possibility of creating a CDS Center for Technological Research and Development and Industrial Cooperation.	Arg.	Ec.
Establishment of a consultation, information and immediate assessment mechanism in the event of situations where peace is at risk.	Ec.	Arg.					Identification of common areas for strategic partnership.	Arg.				
						Promotion of bilateral and multilateral cooperation.	Ven.					

R: responsible. JR: jointly responsible.

### Thematic Meetings

2009	First South-American Meeting of Strategic Studies (Rio de Janeiro, Brazil)	November 11 - 13
	Seminar "Modernization of Defence Ministries" (Quito, Ecuador)	November 19 - 20
	Seminar "A Vision of Defence Conceptual Approaches, Risks and Threats to the Region" (Caracas, Venezuela)	May 26 - 28
2010	"Participation of the Ministries of Defence and the Armed Forces in case of Natural Disasters" Seminar (Ica, Peru)	June 8 - 11
	Defence Industry and Technology Workshop (Quito, Ecuador)	June 29 - 30
	Seminar on Lessons Learnt in Peace Operations (Montevideo, Uruguay)	August 31 - September 3

Source: Compilation based on information provided by the Pro-Tempore Secretariat of the South American Defence Council (Ecuador 2009-2010).



## Conference of American Armies (CAA)

The Conference of American Armies (CAA) was created in 1960, with the aim of becoming a debate forum for the exchange of experiences among the Armies of the American continent. This Conference has twenty Member Armies (Antigua and Barbuda, Argentina, Bolivia, Brazil, Canada, Chile, Colombia, Dominican Republic, Ecuador, El Salvador, Guatemala, Honduras, Mexico, Nicaragua, Paraguay, Peru, Trinidad and Tobago, United States, Uruguay and Venezuela); and 5 Observer Armies (Barbados, Belize, Guyana, Jamaica y Suriname). The Central America Armed Forces Conference (CFAC) and the IADB are observer organizations.

Since 2004, the Conference cycles have been working on the development of manuals related to peace operations. Thus, products have been developed on lessons learned, procedures, terminology, education and training.

### Thematic Evolution in the CAA (1960-2010)

Nbr. - Year	Subjects
I-1960	Operations, information, logistics, control, research and development.
II-1961	Personnel, intelligence, operations, logistics, civil action and military policy.
III-1962	Logistics.
IV-1963	Establishment of communication networks in order to disseminate and exchange information on subversive movements.
V-1964	Administration of training and intensifying preparations of armies in revolutionary wars.
VI-1965	Cooperation between the army and government organizations for better interaction with the social order of the people and organization and training of the army for internal security.
VII-1966	Military system improvement and its incorporation to the Charter of the OAS.
VIII-1968	Hemispheric security.
IX-1969	Communist subversion in the Americas. Education on democracy and training on fighting a revolutionary battle.
X-1973	Strategies against subversion in the Americas for the security of the Hemisphere.
XI-1975	CAA regulations: Security of the Americas, integral educating system in the American Armies (contribute to eradicate subversion).
XII-1977	Integration of the Inter-American system. The fight against communist subversion.
XIII-1979	Improvement of professional education of soldiers. Administrative training. Approval of CAA's Regulations.
XIV-1981	Psychological war. Member Armies guarantee they will not allow other countries' subversive organizations into their territories.
XV-1983	Cooperative action to identify, isolate and neutralize external support to communist subversion in the Americas. Communist threat to hemispheric security.
XVI-1984-85	The Army in a democratic society. Subversion in Latin America? Perspectives and delimitations. Defence coalition in the Americas.
XVII-1986-87	Combating international terrorism: threats, policies and responses.
XVIII-1988-89	Central American conflict. Analysis and assessment of the 78 / 89 period from the political-military viewpoint.
XIX-1990-91	Democracy maintenance in the continent faced with the ideological opening of the communist world. Political, social and economic realities of the American countries.
XX-1992-93	Participation of the American Armies and their reserves in contributing to their governments to guarantee continental security in view of the new world situation. The formation of economic blocks and/or alliances, supported by international organizations, and pressures on the need of the armed forces, their missions and access to technology.
XXI-1994-95	Challenges to the Nation-State. Consequences for continental security and their impacts on the American Armies.
XXII-1996-97	Armies' participation in country development and in international security and peace cooperation activities within the framework of a democratic society.
XXIII-1998-99	The CAA we wish for the 21st century..
XXIV-2000-01	American Armies within the framework of global relations and international law at the beginning of the 21st century. Impacts on national defence.
XXV-2002-03	The American Armies and their contribution to the formation of defence policies in the context of new challenges to continental security.
XXVI-2004-05	The CAA and its contribution to hemispheric security and defence through an increased ability to work together, for Chapter 6 PKO and disaster relief operations.
XXVII-2006-07 XXVIII-2008-09 XXIX-2010-11	The CAA and its contribution to PKOs (developed under UN mandate) and disaster relief operations, through the creation and application of mechanisms and procedures designed to improve the collective capacities and interoperability of their members.

### CAA Cycle

The Conference operates in two-year cycles, and a Permanent Secretariat is established during each cycle, which is under charge of the host country's Army.

Selected subject:

Contribution to peacekeeping and disaster relief operations

**2 years**

**CAA  
(2009)**

**Countries offer themselves as next hosts for the following event, and for the sub-items.**

Specialized conferences, ad-hoc meetings and exercises, with the chosen sub-items. Reports are prepared for the general conference. 2010-2011: CAA 50th anniversary, civil-military relations, science and technology, radio communication exercise and meeting on legal issues in peace operations.

The 2010-2011 cycle mission includes advancing on studies about the advantage of regionalizing certain response capabilities in case of disaster relief and peacekeeping operations; carrying out planning and execution exercises, both in the classroom and in the field; promoting research initiatives in the scientific and technological areas in relation to the chosen general subject; implementing studies on procedures related to environmental protection in military operations; and implementing studies on procedures aimed at facilitating civil-military relations in peace operations and disaster relief.

**CAA  
(2011)**

**New Conference. A host Army is elected.**

**Source:** Compilation based on information provided in the web site of the Conference of American Armies, XXIX Cycle of the Permanent Executive Secretariat of the American Armies Conference (SEPCEA).

### Inter-American Naval Conferences (CNI)

The CNIs began in 1959, when the national navies of the continent were invited to attend the Semi-annual Conference of the Chiefs of Mission of the US Navy. In 1960 a Conference was held in two phases: the first phase was held for the Chiefs of Mission of the US Navy (Key West, Florida); the second was a Multilateral Conference of the Continent's Navies (San Juan, Puerto Rico).

As a result of the debates and discussions held in the two First Inter-American Naval Conferences, the need and convenience of drafting a document that would serve as the Bases for Agreement for future Naval Conferences became evident. Thus, studying common naval problems and stimulating permanent professional contacts became the CNIs' objective.

In 1962, the Bases for Agreement were adopted. Among other things, they established the following:

- The Conference agendas shall be prepared six months in advance and the projects that have to be submitted shall be exchanged three months prior to the Conference date.
- The adopted agreements shall have a Recommendation status, and their adoption shall depend on the respective Navies parties to those agreements.
- The intervals from one conference to the next are established to be of no less than one year and no more than two years.

Until 2010, twenty-three Inter-American Naval Conferences have been held. Its members are the Navies of Argentina, Bolivia, Brazil, Canada, Chile, Colombia, Dominican Republic, Ecuador, El Salvador, Guatemala, Honduras, Mexico, Nicaragua, Panama (National Aero naval Service), Paraguay, Peru, United States, Uruguay and Venezuela. The Inter-American Naval Telecommunications Network (IANTN) and the IADB are observer organizations.

**Source:** Compilation based on the information provided on the website of the XXIV Inter-American Naval Conference's organization.

#### Conference of the Leaders of the Marine Corps of the Americas

The Conference is held every two years. Participating countries are: Argentina, Bolivia, Brazil, Canada, Chile, Colombia, Dominican Republic, El Salvador, Guatemala, Haiti, Honduras, Mexico, Nicaragua, Panama, Peru, United States and Uruguay. The Netherlands and France are observers.

### Cooperation System of American Air Forces (SICOFAA)

The SICOFAA was created on April 16, 1961, within the framework of the First Conference of the Chiefs of the American Air Forces. Its objective is to be a system of integration and cooperation among the American Air Forces or their equivalent, in order to exchange experiences, means, personnel training and education and everything that facilitates the elaboration of procedures.

**Members:** Air Forces of Argentina, Bolivia, Brazil, Canada, Chile, Colombia, Dominican Republic, Ecuador, El Salvador, Guatemala, Honduras, Nicaragua, Panama (National Aero naval Service), Paraguay, Peru, United States, Uruguay and Venezuela. Observers: Belize, Costa Rica (Air Surveillance Service), Guyana, Haiti, Jamaica and Mexico.

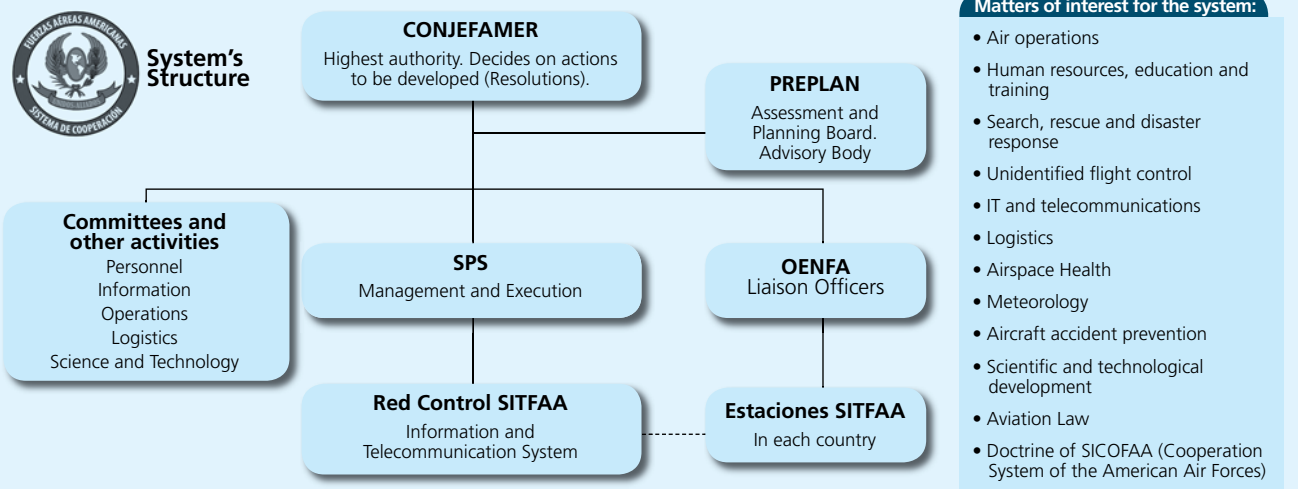

### Inter-American Air Forces Academy (IAAFA)

The Inter-American Air Forces Academy (IAAFA) was founded on March 15, 1943. It is located in Lackland Air Force Base, Texas, United States.

Its stated mission is to train and educate the military forces to build and generate abilities for the support of world stability and security, while generating academic and cultural relations. It offers training courses for Officers (ISOS) and professional training courses for Non-Commissioned Officers (INCOA).

During the period 2010-2011, the System Committees are devoted to the development of a Procedure Manual to respond to natural disasters. In October 2010, the Cooperation Exercise I shall be executed, with Chile acting as the host country (see Chapter 7 of this publication).

Country	2008 Graduates*	2009 Graduates*
Argentina	68	40
Bolivia	5	6
Brazil	0	5
Chile	14	18
Colombia	165	278
Dominican Republic	23	13
Ecuador	64	42
El Salvador	7	13
Guatemala	19	9
Honduras	8	11
Mexico	71	89
Nicaragua	7	5
Paraguay	8	14
Peru	74	90
Uruguay	5	12
Venezuela	0	0

\* Mobile equipment and expert exchange are included.

**Source:** SICOFAA Permanent Secretariat, website of the Chilean Air Forces, and Charter of the System (July 2007).



## US Southern Command

SOUTHCOM, headquartered in Miami, Florida, is one of the ten Unified Combatant Commands (UCC) of the Department of Defense. It is charged with the task of providing planning, operations and cooperation in security for 32 countries in the Americas, except for Mexico (which forms part of the Northern Command (1)), and the 12 islands which are States or territories under European sovereignty (the territories forming part of the US administration are also excluded). It also has jurisdiction in part of the Atlantic and Pacific Oceans (the waters adjacent to Central American and Caribbean countries, between 30° and 92° West meridians) and the Gulf of Mexico. The Panama Canal is within SOUTHCOM's jurisdiction.

### Joint Interagency Task Force-South (JIATFS)

The working group has the mission to detect, follow-up and support interdiction to disarticulate illicit trafficking, including drug trafficking in the Caribbean Sea, the Gulf of Mexico and the Eastern Pacific. It is located in Key West and has representatives from Argentina, Brazil, Chile, Colombia, Dominican Republic, Ecuador, El Salvador, France, Mexico, Peru, Spain, The Netherlands, and United Kingdom.

### Objectives proposed for 2010

- Expand humanitarian activities, build friendships and attract allies at local and regional levels.
- Integrate military and civilian efforts, through higher interaction with other government agencies.
- Provide advice to foreign security forces and enhance their combat capacity against narco-terrorism/terrorism.
- Implement a new development of public-private cooperation and a strategy for corporate commitment.
- Expand exercises, country participation and military –to- military commitment with allies.
- Focus on community extension and improvement of the US Government and SOUTHCOM profile in local community.
- Work jointly with other government agencies in order to train and equip partner nations and propose initiatives that deal with common security challenges.

### SOUTHCOM Security Assistance Offices in the Americas (2)

Argentina, Barbados, Belize, Bolivia, Brazil, Chile, Colombia, Costa Rica, Dominican Republic, Ecuador, El Salvador, Guatemala, Guyana, Haiti, Honduras, Jamaica, Nicaragua, Panama, Paraguay, Peru, Surinam, Trinidad and Tobago, Uruguay and Venezuela.

### Mutual Assistance Pacts

Since the mid 20th century, military assistance agreements, also known as mutual assistance pacts, have been signed between the US and countries of the region. In various cases, these agreements have ceased to be implemented or were superseded by hierarchically higher standards. They form the basis for personnel, training and equipment assistance as well as for the so-called military groups.

(1) It comprises the continental territory of the United States, Alaska, Canada, Mexico and the surrounding waters up to approximately 500 nautical miles. It also includes the Gulf of Mexico, the Florida Strait and parts of the Caribbean to include Bahamas, Puerto Rico and US Virgin Islands.

(2) Each office is composed of at least one serving military person established in the US embassy. Its missions include providing financial and technical assistance, transfer of resources, and training and services to host countries, as well as promoting military-military contacts.

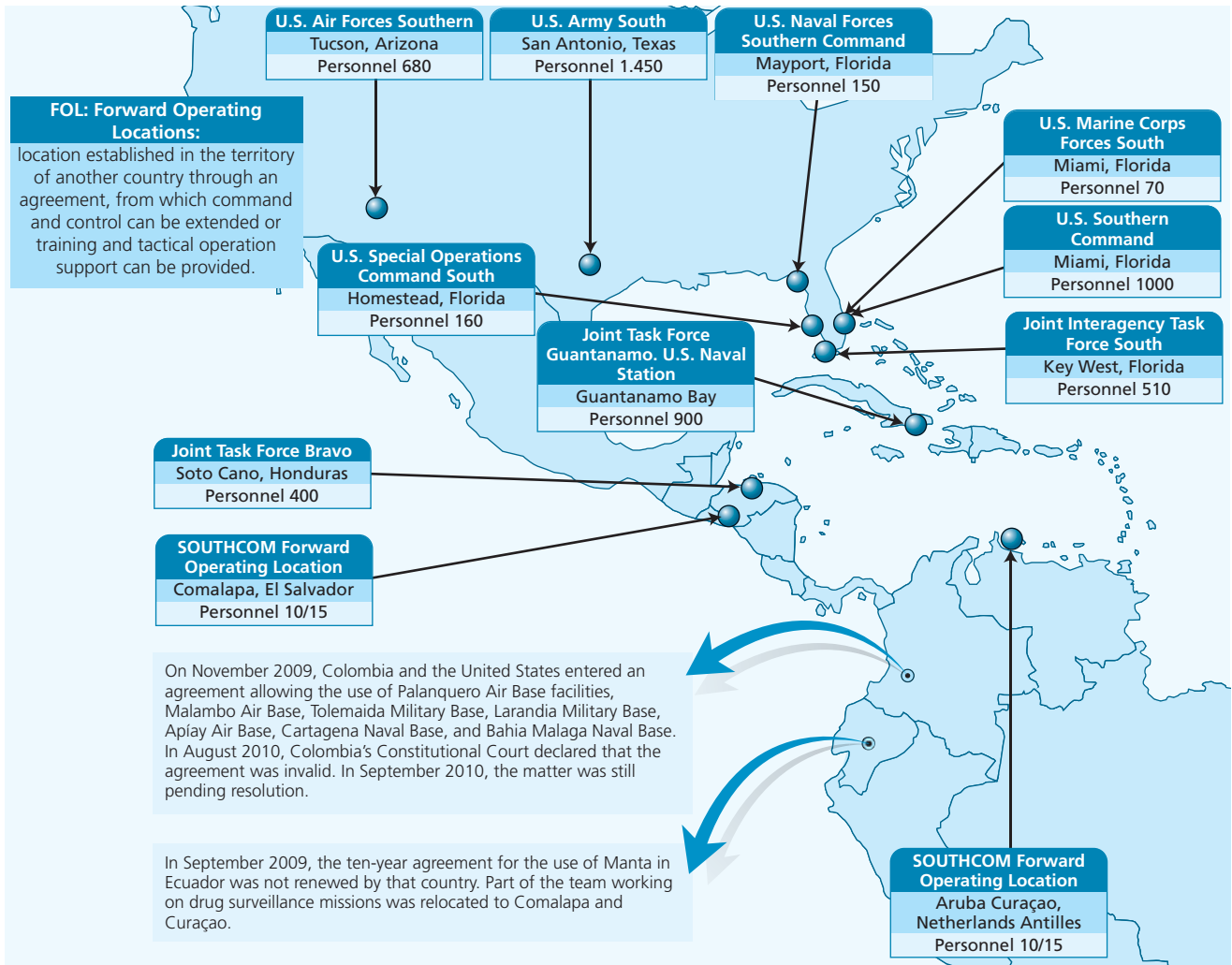

### Interagency

In September 2007, the Secretary of Defence authorized the reorganization of Southern Command to convert it into an inter-agency structure, which was fully approved in October 2008. In response to the idea of the “whole of government approach”, the Department of Defence implemented that year the Orientation Guidelines for the Use of the Force, aiming at a higher participation of other Departments. Southern Command was designated as the prototype of this comprehensive approach (and, once established, the African Command as well). Thus, the structure is composed of representatives of other agencies occupying key positions.

#### Represented Agencies\*:

- State Department (DOS): 7 (FT)
- United States Agency for International Development (USAID): 2 (FT)
- Department of Homeland Security (DHS) (it includes ICE): 3 (FT) 7 (PT)
- Office of the Director of National Intelligence: 3 (FT)
- Bureau of Alcohol, Tobacco, Firearms and Explosives (ATF): 1 (PT)
- Defense Criminal Investigative Service: 1 (FT)
- Defense Intelligence Agency (DIA): 2 (FT)
- Department of Energy (DOE): 1 (FT)
- Drug Enforcement Administration (DEA): 1 (FT)
- Federal Bureau of Investigation (FBI): 2 (FT) 2 (PT)
- Department of Transportation (DOT): 1 (PT)
- Transportation Security Administration (TSA): 1 (PT)
- Coast Guard: 2 (FT)
- Department of Commerce (DOC): 1 (FT)
- Department of Health and Human Services (HHS): 1 (FT)
- Government Accountability Office (GAO): 1 (PT)
- Environmental Protection Agency (EPA): 1 (PT)

Total representatives of other Agencies: 40

\*Representatives can be full time (FT) or part time (PT) representatives.

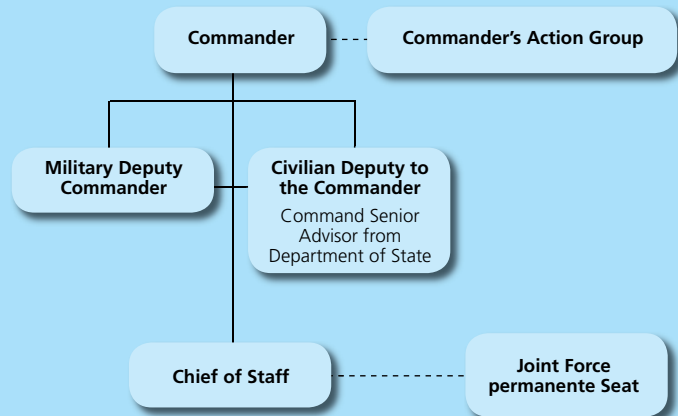

#### U.S. Naval Forces Southern Command (COMUSNAVSO)

It is responsible for US forces and military means operating in Latin America and the Caribbean. It manages all naval units under the responsibility of the Southern Command.



Fourth Fleet

Assigned to COMUSNAVSO. It operates jointly with other Southern Command components. One of the operations conducted is the Continuing Promise Mission. This is an annual humanitarian and civil assistance operation developed in the Caribbean, Central and South America under the naval component charge of Southern Command and the US Naval Forces Southern Command. This mission is conducted in cooperation with partners from other agencies, as well as non-governmental organizations and other international partners.

#### Southern Command (SOUTHCOM)

#### Deployment of the Continuing Promise Mission

Ships	Date of development	Route
USNS Comfort	June – October 2007	Belize, Colombia, Ecuador, El Salvador, Guatemala, Guyana, Haiti, Nicaragua, Panama, Peru, Suriname, Trinidad and Tobago.
USS Boxer and USS Kearsarge	April - November 2008	Colombia, Dominican Republic, El Salvador, Guatemala, Guyana, Haiti, Nicaragua, Peru, Trinidad and Tobago.
USNS Comfort	April - July 2009	Antigua and Barbuda, Colombia, Dominican Republic, El Salvador, Haiti, Nicaragua, Panama.
USS Iwo Jima	July –November 2010	Colombia, Costa Rica, Guatemala, Guyana, Haiti, Nicaragua, Panama, Suriname.

#### Beyond the Horizon 2009\*

It conducts humanitarian assistance exercises. As part of the programme, troops specialized in engineering; construction and healthcare provide services and information to the communities. In 2009, the exercise was carried out in Colombia, Jamaica, Honduras, Dominican Republic, Suriname and Trinidad and Tobago.

\*Other exercises conducted by the Southern Command are specified in the English language Caribbean dossier.

Source: Southern Command Public Affairs Office. U.S. Southern Command Demonstrates Interagency Collaboration, but Its Haiti Disaster Response Revealed Challenges Conducting a Large Military Operation, Report of the United States Government Accountability Office (July 2010).

### Merida.

In October 2007, the State Department developed the Merida Initiative, which (together with other federal government agencies), is charged with providing assistance against drug-trafficking and organized crime in Mexico and Central America. This initiative includes military assistance funds. For financial year 2010, the Initiative divided the funds granted in the region. The Merida-Mexico Initiative was maintained and the Central America Regional Security Initiative (CARSI) and the Caribbean Basin Security Initiative (CBSI)\* were created.\*

\*For more information on the CBSI, see the English language Caribbean dossier.

#### Funds of the US State Department for Security and Defence (in millions of dollars)

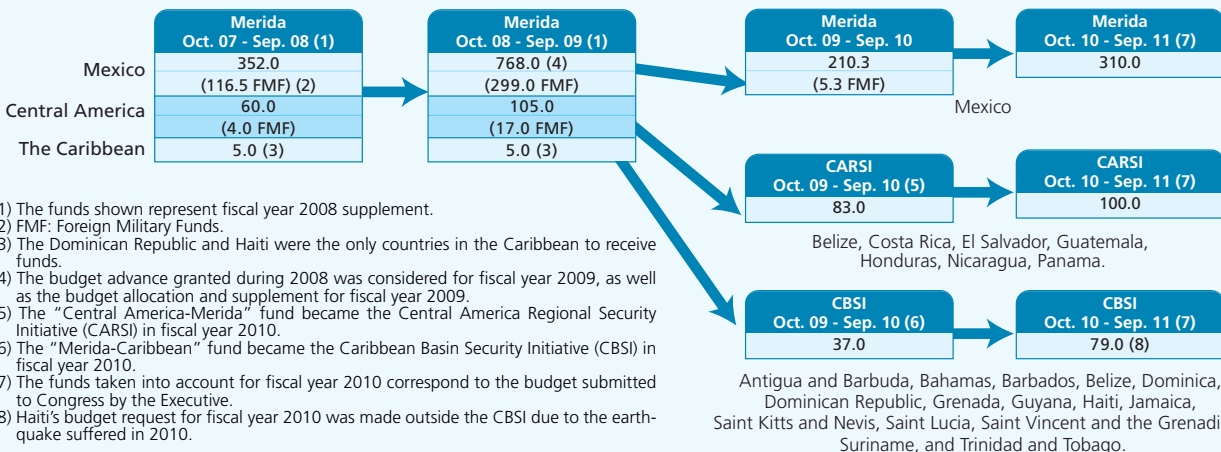

Source: MERIDA INITIATIVE: The United States Has Provided Counternarcotics and Anticrime Support but Needs Better Performance Measures, United States Government Accountability Office. Merida Initiative for Mexico and Central America: Funding and Policy Issues, Congressional Research Service, and laws P.L. 110-252 (2008), P.L. 111-8 (2009), P.L. 111-117 (2010), of the United States.



## Bilateral and Sub-Regional Defence Agreements

Colombia – El Salvador: Memorandum of Understanding (2006).  
 Colombia – Guatemala: Memorandum of Understanding on Military Technical Cooperation (2005).  
 Colombia – Honduras: Inter-Institutional Agreement on Maritime Cooperation (2005). Framework Agreement on Technical Cooperation (2010).  
 Colombia – Dominican Republic: Agreement and Addendum on Military Cooperation and Defence (2005 – 2007).  
 El Salvador – Peru: Cooperation Agreement in the Defence sphere and New Threats to Security (2008).  
 Nicaragua – Peru: Agreement on Technical Assistance for Maritime Security and Water Environment Protection (2004).  
 Mexico- Colombia: Agreement on Maritime Cooperation (2005).

### Andean Region

- Bolivia – Chile: Memorandum of Understanding.
- Bolivia – Ecuador: Agreement for military cooperation (2008).
- Bolivia – Peru: Consultation Mechanism (2010).
- Bolivia – Venezuela: Basic Agreement and Supplementary Agreement on Technical Cooperation (1973 - 2006). Memorandum of Understanding (2008).
  - Colombia – Ecuador: Binational Border Commission (1996).
  - Colombia – Peru: Agreement on Conversations among Air Forces High Commands (1994). Agreement to Fight Illicit Activities in Common Border Rivers (2002). Mechanisms for Political Consultation and Coordination (2007).
  - Colombia – Venezuela: Declaration of Principles and Cooperation Mechanism (2010).
  - Colombia – Bolivia: Memorandum of Understanding on Military Technical Cooperation (2004).
    - Ecuador – Peru: Binational Commission on confidence building and security measures (1998). Permanent Mixed Commission on borders (2000). Mechanism for Political Consultation and Coordination (2007). Memorandum on Mutual Support in case of Natural Disasters and Binational Civil Action (2010).
  - Andean Charter for Peace and Security, and Limitation and Control of Expenses Assigned to External Defence (Lima Commitment, CAN) (2002)
  - Guidelines for the Common External Security Policy of the Andean Community (Decision 587, CAN) (2004).

**Ilo Maritimo Pact between Peru and Bolivia (10/19/2010)**  
 Peru has ceded, renewed and expanded for Bolivia a special industrial and economic free trade zone (ZOFIE, acronym in Spanish) and a tourist free zone (Mar Bolivia) for 99 years, which gives land-locked Bolivia a permanent access to the Pacific Ocean.

Andean Peace Zone (2004)

### Central America and Mexico

- Defence Sub-Committee - Security Commission of Central America – SICA
- Agreement for the creation of the Central America Armed Forces Conference- CFAC (1997).
- Central America permanent program for confidence building and security measures (SICA) (2006).
- Central America and Mexico security strategy (SICA) (2007).
- El Salvador – Guatemala – Honduras: Joint Agreement to Fight against Illicit Drug-Trafficking (2010).
  - Mexico- Guatemala: Agreement on Cooperation for the Prevention of and Assistance in Case of Natural Disaster (1987).
  - Mexico - Panamá: Information Exchange on Intelligence (2005)

Framework Treaty on Democratic Security (1995)

- Mexico - Chile: Cooperation Agreement (2003).
- Mexico - Uruguay: Cooperation Agreement (2004).
- Argentina – El Salvador: Cooperation Agreement (2009).
- Argentina – Honduras: Cooperation Agreement (2006).
- Brazil – El Salvador: Cooperation Agreement (2007).
- Brazil – Guatemala: Cooperation Agreement (2006).
- Brazil – Honduras: Cooperation Agreement (2007).
- Brazil – Dominican Republic: Bilateral Cooperation Agreement (2010).
- Chile – Guatemala: Memorandum of Understanding for Cooperation (2003).
- Chile – El Salvador: Statement of Intent for Bilateral Cooperation (2001).

### Southern Cone

- Argentina – Brazil: Memorandum of Understanding for Consultation and Coordination (1997). Collaboration Protocol for Military Manufacturing (1997). Agreements on Technological Cooperation (1999, 2002, 2003, 2005). Master Agreement and Protocol on Cooperation (2005 – 2008).
  - Argentina – Chile: Memorandum of Understanding for Strengthening Security Cooperation (1995). Agreement of Cooperation in Case of Disaster (1997). Memorandum of Understanding for Technical, Scientific and Logistic Development Cooperation (2001). Combined Peace Force (2005).
  - Argentina – Paraguay: Agreement for Paraguay's Army Participation in the Argentine Task Force deployed in Cyprus (2003). Agreement and Protocol for Strengthening Cooperation (2007). Cooperation Agreement (2008).
  - Argentina – Uruguay: Agreement for Strengthening Cooperation (2010).
  - Brazil – Chile: Bilateral Work Team (2000). Cooperation Agreement (2007).
  - Brazil – Paraguay: Military Cooperation Agreement (1995). Framework Agreement on Cooperation (2007). Binational Mechanism for Strategic Consultation (2007).
  - Brazil – Uruguay: Cooperation Agreement (2010).
  - Chile – Uruguay: Cooperation Agreement (2007). Agreement for Strategic Partnership (2008).

Peace Zone (1998)

\*Suspended

**Sources:** Information provided by the Ministries of Defence of Argentina, Chile, Colombia and El Salvador. Gaceta Oficial and Libro Amarillo (from 2006 to 2009) of the Bolivarian Republic of Venezuela. Libro de la Defensa Nacional de Nicaragua, 2005. Web pages of Peru and Uruguay's Ministries of Defence; Ministries of Foreign Relations of Argentina, Ecuador, Mexico, Nicaragua, Peru and Venezuela; Uruguay's Parliament; Brazil's Federal Senate.

**Agreements and treaties between Latin American countries and other countries in the world**

United States	17	1 out of 1 country has signed an agreement or treaty with the US.
Spain	15	7 out of 8 countries have signed an agreement or treaty with Spain.
Russia	9	1 out of 2 countries has signed an agreement or treaty with Russia.
China	8	1 out of 2 countries have signed an agreement or treaty with China.
Canada	7	2 out of 5 countries have signed an agreement or treaty with Canada.
France	7	2 out of 5 countries have signed an agreement or treaty with France.
Germany	5	2 out of 7 countries have signed an agreement or treaty with Germany.
Italy	5	2 out of 7 countries have signed an agreement or treaty with Italy.
United Kingdom	4	1 out of 4 countries has signed an agreement or treaty with the UK.
India	3	1 out of 6 countries has signed an agreement or treaty with India.
South Korea	3	1 out of 6 countries has signed an agreement or treaty with South Korea.
Poland	3	1 out of 6 countries has signed an agreement or treaty with Poland.
South Africa	3	1 out of 6 countries has signed an agreement or treaty with South Africa.
Netherlands	2	1 out of 9 countries has signed an agreement or treaty with the Netherlands.
Israel	2	1 out of 9 countries has signed an agreement or treaty with Israel.
Turkey	2	1 out of 9 countries has signed an agreement or treaty with Turkey.
Ukraine	2	1 out of 9 countries has signed an agreement or treaty with Ukraine.

**Note:** In July 2010, the Legislative Assembly of Costa Rica approved the request for the docking, staying at port and disembarking of the crews of 46 vessels of the US Navy (maximum authorized crew 13,291 troops). Said authorization was granted until December 2010 in the framework of the agreement signed by Costa Rica and the US in 1999 the object of which is antinarcotics operations in support to the US Coast Guard.

**Source:** Legislative Assembly of Costa Rica.

**Note:** Spain (Argentina, Bolivia, Chile, Colombia, Cuba, Ecuador, El Salvador, Guatemala, Honduras, Mexico, Nicaragua, Peru, Dominican Republic, Uruguay and Venezuela). Russia (Argentina, Bolivia, Brazil, Chile, Colombia, Nicaragua, Peru, Uruguay and Venezuela). Canada (Argentina, Bolivia, El Salvador, Guatemala, Honduras, Mexico and Peru). China (Argentina, Bolivia, Brazil, Colombia, Ecuador, Peru, Uruguay and Venezuela). France (Argentina, Brazil, Chile, Colombia, Nicaragua, Peru and Venezuela). Germany (Argentina, Brazil, Chile, Ecuador and Peru). Italy (Argentina, Brazil, Chile, Colombia and Peru), United Kingdom (Argentina, Brazil, Colombia and Chile). India (Brazil, Chile and Colombia). South Korea (Brazil, Colombia and Ecuador). Poland (Chile, Colombia and Peru). South Africa (Brazil, Chile and Uruguay). The Netherlands (Chile and Colombia). Israel (Colombia and Peru). Turkey (Brazil and Chile). Ukraine (Argentina and Brazil).

**Source:** For further details, see references in table “Bilateral and Sub-Regional Defence Agreements” of this Chapter. China: Ministry of National Defence. Spain: Ministry of Defence. United States: State Department.

## US Southern Command Relations with the Region

George Withers

WOLA – Washington Office for Latin America

The potential for military conflict in the U.S. Southern Command’s “area of focus” – Latin America and the Caribbean – is considered among the lowest of all the regional combatant commands. Lately, Southcom has chosen to emphasize its partnership initiatives – with the countries of the region, and domestically with other agencies of the U.S. Government.

All has not gone well in these two endeavours, however. While the Command engages with other countries in several joint naval exercises each year, the region was taken by surprise when, in April 2008, the Navy announced that it was, after several decades, re-establishing the Fourth Fleet in the region. Many viewed this as an unnecessary and provocative escalation of U.S. military presence in the waters of Latin America’s waters.

Then, almost exactly one year later, the Department of State announced the details of a new “Defence Cooperation Agreement” between the United States and Colombia. This would significantly expand the U.S. military’s access to several bases in that country. Internal Department of Defence documents alluded to the potential to conduct “full spectrum operations” throughout the hemisphere. Again, several countries expressed their alarm and demanded to know the Southern Command’s intentions in the region. While the partnership programs intend to build bridges, these confusing signals work against the improved relations that the Southern Command claims to seek in Latin America and the Caribbean.

Domestically, the Southern Command is the first combatant command to explore the concept of broadening its mission beyond a traditional military focus. In 2006, the

Command announced its intention to become an “inter-agency” command, modifying its structure to include representatives of several civilian agencies. Today, the Combatant Commander retains his position at the top, and is served by two deputies – one for the military components and one for the civilian agencies. Officials explain that this will allow the military to better coordinate with these agencies in the delivery of U.S. assistance throughout the region. The House and Senate Armed Services Committees and the Government Accountability Office have expressed concerns over this new structure.

Now, the Command views the region more broadly. While many problems are transnational in nature and are the result of economic, social and political dynamics, increasingly, these are increasingly seen as “security threats” to the United States. This is true whether it be economic instability, street gangs, narcotics trafficking, or other problems. Many view Southern Command’s involvement in these issues as interagency overreaching. It presents the very real possibility that the U.S. military will be seen as the “go-to organization” for all U.S. assistance, not just military aid. But perhaps most important, it accelerates an ongoing tendency to militarize U.S. foreign policy.

There should be no doubt that the U.S. Southern Command can, and often does, act as a force for good in the region. The military’s tireless efforts in the immediate aftermath of natural disasters, for instance, should not be overlooked. However, because of apparent Southern Command expansions – both structurally and in its presence – the region remains concerned about the continuing spectre of unwanted U.S. military activity.





## Analysis

# Brazil's Role in the Hemisphere

**María Celina D'Araujo**

*PhD in Political Science and Master from PUC-Rio*

Over the past few years, Brazil's role in the context of hemispheric relations dominated a large part of the defence and international relations literature and has given rise to intellectual and ideological debates. In this paper we argue that Brazil will not become a leader in the traditional sense of appearing as the representative of other countries and that it would encounter many challenges if it tried to become a local power with imperialist ambitions. The diplomatic history of the country, its economic development and its focus on avoiding direct confrontation with the United States discourage this kind of inferences. Witness to this is the fact that since the 1970s Brazil has been working, especially with Chile and Argentina, to create sub-regional institutions and discussion and consulting forums, and never presented itself as an alternative to block the United States.

A recent example of this effort is the creation, in 2008, of the Union of South American Nations (UNASUR) and other organizations derived from it, including the South American Defence Council (CDS). These new institutions are a prerequisite for the region to speak by consensus without resigning bilateral and multilateral channels. Historically, no country in Latin America has accepted the leadership of a third party entitled to speak on their behalf. Brazilian diplomacy has always been aware of that and it has never encouraged the country to assume any leadership role, even though some political parties may have appreciated that kind of project.

The expectations of leadership in Brazil, however, are not recent and have acquired new life after economist Jim O'Neill in 2001 coined the term BRIC. The acronym represents the initial letter of the four main emerging countries of this century (Brazil, Russia, India and China) giving Brazil greater international projection and generating a wave of speculation on Brazil's role in the world. The "group" was also expected to become a political bloc, which never actually happened. Strictly speaking,

what these four states have in common is the fact that they are continental countries and that they are in the top ten regarding surface area and population and among the top twelve in terms of wealth production.

Their macro-structural data also show worrying realities from the social and political standpoints. The per capita income ranges from US\$11,000 per year in Russia to US\$1,000 in India. Brazil, with a per capita income of US\$7,000 per year is, however, the one with the highest disparity in the group and one of those with the highest inequality in the world. Overall, these are countries with many problems in the social and transparency areas, and with huge differences in their political systems, not to mention their cultural differences. In all of them, however, growth rates are expected to be equal to or exceed those in other emerging countries. This means they may expand their economies and gain new markets. In this sense, the term BRIC does not refer to important and fundamental issues such as democracy, the fight against corruption, social inequality, environment protection or defence.

In any case, the term BRIC gave Brazil greater visibility abroad even though it did not give it more decision power nor did it make it a global player with more weight in the world or even in the Americas. Brazil's economic and territorial weight in Latin America contributed to generating, along the history, expectations over a potential Brazilian leadership, but asymmetries in relation to its neighbours have prevented and continue to prevent that leadership to be legitimated. Quite to the contrary, the perception has grown that Brazil could, in the 21st century, become a regional imperialist power which, in turn, might hinder the strengthening of cooperation and confidence building measures. However, together with such debate, it became evident that in the region, the creation of institutions based on clear and shared principles is more important than the emergence

of or the boycotts to any leadership.

At this point, it should be noted that hemispheric leadership is not in question. The United States are a military, economic and cultural super power; the largest empire that history has known, with a leadership based on its strength and economy, but also on cultural and behavioural influences. On the other hand, Brazilian diplomacy has received with great caution the demands to assume a more marked leadership role among Latin countries in the Hemisphere. This trend started to change slowly since the 1990s with the Fernando Henrique Cardoso administration, when the region's geopolitics seemed to have changed. While Mexico reinforced its bonds with the United States through the North American Free Trade Agreement, South America appeared as a more integrated space, more independent from North American influence. Central America, in turn, continues to develop a direct line with the United States, for different structural reasons that will not be discussed here.

Therefore, when speaking of Brazil's potential leadership nowadays it should be made clear that if such potential should exist, it would be limited to South America. And, in any case, it would not be a leadership concurrent with that of the US, nor would it be of a personal but of an institutional character.

Historically, Brazil has shown little interest in regional defence affairs, whether because it defended the principle of non-intervention or because the region has never been an area with large and frequent armed conflicts. Whenever regional security has been at stake, Brazil chose to support negotiated and multilateral solutions.<sup>1</sup> In the same manner, with the only exception of the war against Paraguay, Brazil has never felt threatened and this has led the country to never take an active role in the regional debate on defence. As time went by, the security of the continent was a subject more cared about by Brazilian diplomacy than by its armed forces. This started to change also in the 1990s, placing the focus in South America, but always with the concern of not generating tension with the United States.

The end of the Cold War opened the possibility of holding conversations with Argentina and starting conversations on the reduction of nuclear weapons, the signing of the Nuclear Non Proliferation Treaty and the search for new roles for the military. In the absence of communism as an internal enemy and being in good terms with past enemies in the region, the defence matters in Brazil were limited to the Amazonia, where border policies are

more actively implemented and modern technologies for air traffic control and services shared with neighbouring countries are deployed. Therefore, Brazil's entry in the regional defence debate was gradual and limited: it is now about South America, understood as a security unit, but also as a possibility of joint infrastructure and defence industry projects in political democratic environments. Brazil has been, since then, more of a protagonist in South America, and from Lula da Silva's administration (2002-2010) on it has shown greater interest in defence matters. This was made clear in 2008 with the publication of the National Defence Strategy, a document that reveals the political ambitions of the country to develop its defence industry and make it a driver of the country's industry and technology development.

At the same time, the CDS was created under Brazilian initiative, which gave rise to several interpretations. Two of them ultimately show concern or disbelief about its creation. On the one hand, some see it as a statement of Brazil intended to strengthen its regional and world leadership, rising as an asymmetrical power in South America, always in concert with United States' interests. This would be part of a Brazilian strategy to gain a seat at the United Nations Security Council and become a stronger international leader, an intermediate state at world level, representing the interests of the region. Thus it would be part of Brazil's global ambitions after having surpassed Argentina as the region's leader. Given this context, the country would be giving continuity to its nuclear submarine construction project and re-equipping its land and air forces. Within this formulation, the Council could also be thought of as part of Brazil's plans to strengthen its defence industry and turn it into the main supplier in the region.<sup>2</sup> On the other hand, other analysts see this move as more of a formal intention with little, if any, effective power vis-à-vis US military and political hegemony. In this sense, according to Alsina Junior<sup>3</sup>, South America "does not have sufficient weight to alter the world's strategic balance," especially in light of the fact that its main power, Brazil, is an actor with "little significance from the military viewpoint." Thus, the fact that Brazil is indeed the strongest country in South America has little meaning in the context of international security in light of the weakness of its defence apparatus.

Both interpretations are made on the basis of the paradigm of disputes for regional leadership and reveal the

<sup>1</sup> See on this matter, Luiz Bitencourt, "Seguridad en el nuevo mundo: Brasil y el dilema del liderazgo mundial", in *La Seguridad desde las dos Orillas*, ed. Rafael Martínez and Joseph S. Tulchin, (Barcelona: CIDOB, 2006).

<sup>2</sup> See, for example, Raúl Benítez Manaut, Pablo Celi and Rut Diamint, "Los desafíos de la Seguridad y la Defensa en Latinoamérica: entre las nuevas amenazas, la nueva geopolítica y los viejos conflictos", in *Seguridad regional en América Latina y el Caribe - Anuario 2009*, ed. Hans Mathieu and Paula Rodríguez Arredondo, Friedrich Ebert Stiftung.

<sup>3</sup> João Paulo Soares Alsina Júnior, *Política externa e poder militar no Brasil, universos paralelos*, (Rio de Janeiro: FGV, 2009), 57.



recurring suspicion around Brazil and the United States. However, going beyond the conspiracy-simulation dichotomy, it is important to consider the Council as part of a process to redefine regional security policy and, as further proof of the concern for the institutionalization of the defence cooperation and debate forum for the countries of the region based on the principle of military subordination to civil power. Beyond the idea of reactive defence alliances, like the Inter-American Treaty of Reciprocal Assistance (TIAR), the Union of South American Nations (UNASUR) and the South American Defence Council (CSD) -with all twelve countries involved- they tend, like the Conference of Defence Ministers of the Americas (CDMA), to invest in conflict prevention, a position backed by the “empire” from the beginning, which frustrated the Venezuelan proposal to create a “Southern” NATO with a defence and operational character.<sup>4</sup>

The proposed South American Defence Council was clearly inspired by the European integration model, with less ambitious objectives, mainly geared to create a mutual confidence and transparency climate in the relation among States. On joining the CDS, then Colombian President Alvaro Uribe asked other countries to get involved in the fight against terrorism and conditioned their adherence to the Council to the approval of three requirements: Council decisions must be adopted by consensus; the Council should make clear that there would be explicit acknowledgement of the institutional forces established in each country's Constitution; and all violent and/or irregular armed forces

should be rejected, regardless of their origin. Finally, in December 2008, at the special UNASUR meeting in Brazil, the Council was ratified as a “defence matters consultation, cooperation and coordination” body. Its explicit objectives are consolidating South America as a peace area, building a regional identity in defence matters, and attaining consensus to strengthen regional cooperation.

As a matter of fact, the National Defence Strategy, by emphasizing the defence industry, seems a measure supplementary to CDS objectives and it is this precisely what has generated such distrustful reactions. The Strategy seems to have been motivated by two concurring principles reflecting the government's comfort and enthusiasm as regards the country's potential: economic and political stability on the one hand, and prominence in the international context on the other. In this new scenario, Brazil would need to consolidate “its position in the world”.

It should be noted, however, that a large part of the issues posed for the National Defence Strategy might never become anything but good intentions. Except for the mandatory military service, what the document calls for involves large amounts of funds that need to be approved in a number of Legislative and Executive instances in a context of resource scarcity. Thus, the document formally responds to military and leftist groups' demands of more weapons and projection, but does not seem to have the strength to redirect the balance position that Brazil has maintained over its history in relation to its neighbours. Nothing seems to indicate that Brazil, despite its growing protagonist role in South America, will alter its traditional stance for balance, moderation, negotiation and dialogue.

<sup>4</sup> A brief history of the CDS is available at: Consejo Sudamericano de Defensa, “Publicaciones”, UNASUR, <http://www.cdsunasur.org/es/prensa/publicaciones>.

Chapter 6:

# Education

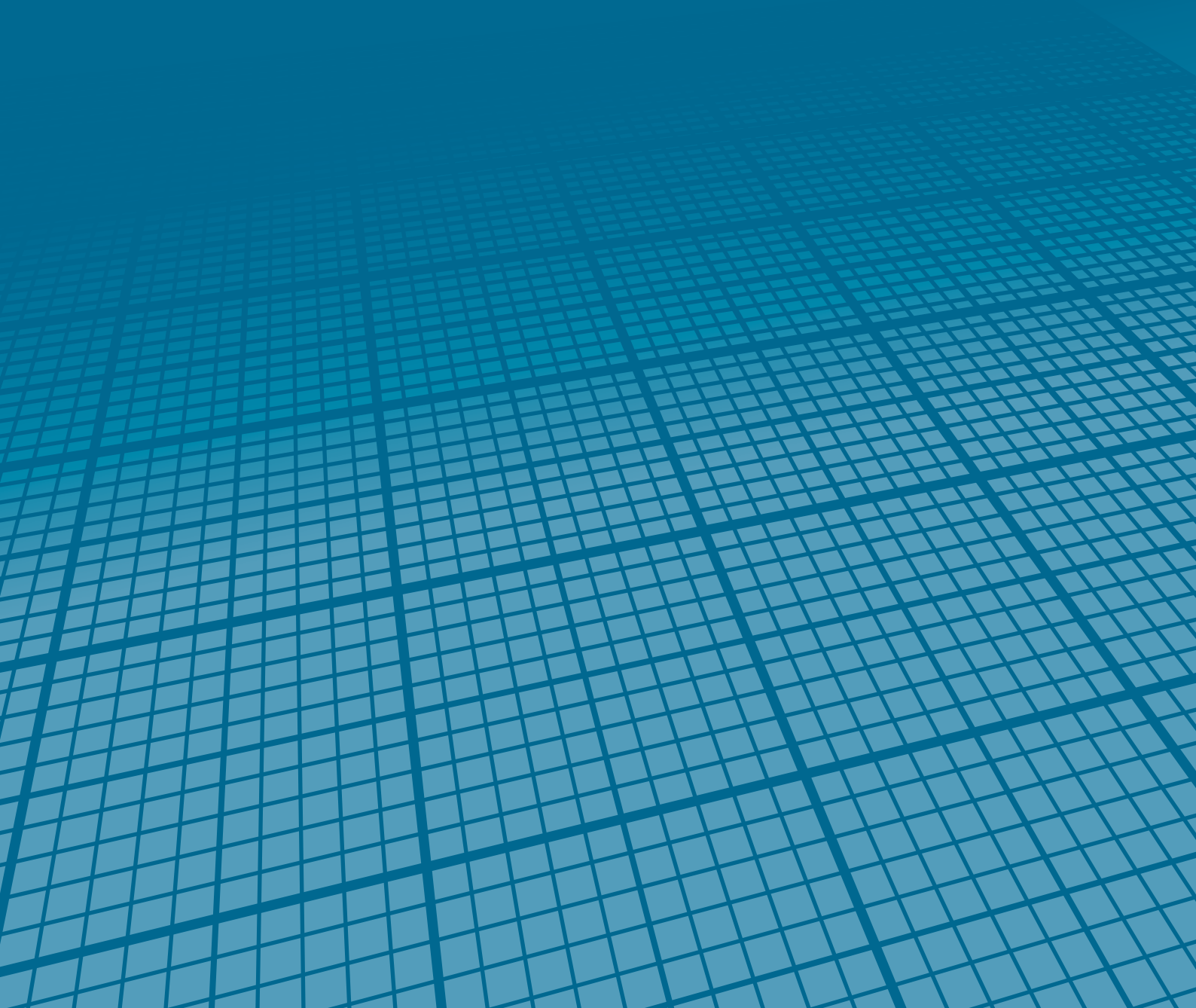



## Main colleges with a Defence course offering

Country	Institution
<b>Argentina</b>	<ul style="list-style-type: none"> <li>- National Defence School</li> <li>- Superior War School "Teniente General Luis María Campos"</li> <li>- Naval War College</li> <li>- Argentine Centre for Joint Training in Peace Operations</li> <li>- University of La Plata</li> <li>- Torcuato Di Tella University</li> </ul>
<b>Bolivia</b>	<ul style="list-style-type: none"> <li>- University for Strategic Research in Bolivia (UPIEB)-Ministry of the Presidency - Ministry of Defence and Ministry of Government</li> <li>- National School of Higher Education Studies "Coronel Eduardo Avaroa"</li> <li>- Centre for Peacekeeping Operations of the Bolivian Army (COMPEBOL)</li> </ul>
<b>Brazil</b>	<ul style="list-style-type: none"> <li>- Superior War School</li> <li>- Universidad Estadual Paulista, Universidad Estadual of Campinas, Catholic University of São Paulo"</li> <li>- Joint Centre for Peacekeeping Operations in Brazil</li> </ul>
<b>Chile</b>	<ul style="list-style-type: none"> <li>- Pontifical Catholic University of Chile</li> <li>- National Academy of Political and Strategic Studies</li> <li>- University Andrés Bello</li> <li>- Army War College</li> <li>- Joint Centre for Peacekeeping Operations</li> </ul>
<b>Colombia</b>	<ul style="list-style-type: none"> <li>- Superior War School</li> <li>- Military University Nueva Granada</li> </ul>
<b>Cuba</b>	<ul style="list-style-type: none"> <li>- Raul Roa Garía Institute of Higher International Affairs Studies</li> <li>- Defence Information Centre</li> <li>- National Defence College</li> </ul>
<b>Dominican Republic</b>	<ul style="list-style-type: none"> <li>- Graduate School of Higher Security and Defence Studies</li> <li>- Graduate School of Human Rights and Humanitarian International Law</li> </ul>
<b>Ecuador</b>	<ul style="list-style-type: none"> <li>- Institute of National High Studies</li> <li>- The Peacekeeping Unit School "Ecuador" (UEMPE)</li> </ul>
<b>El Salvador</b>	<ul style="list-style-type: none"> <li>- College of High Strategic Studies</li> </ul>
<b>Guatemala</b>	<ul style="list-style-type: none"> <li>- Minister of Defence (with the guarantee of San Carlos University, University Francisco Marroquin and Panamerican University)</li> <li>- Superior Command of Education of the Army</li> <li>- Security in Democracy</li> <li>- ESTNA Centre (Foundation for the Institutional Development of Guatemala)</li> </ul>
<b>Honduras</b>	<ul style="list-style-type: none"> <li>- National Defence College</li> </ul>
<b>Mexico</b>	<ul style="list-style-type: none"> <li>- Centre for Superior Naval Studies</li> <li>- National Defence College</li> </ul>
<b>Nicaragua</b>	<ul style="list-style-type: none"> <li>- Nicaraguan Army</li> </ul>
<b>Paraguay</b>	<ul style="list-style-type: none"> <li>- Institute of High Strategic Studies</li> <li>- Metropolitan University of Asunción</li> </ul>
<b>Peru</b>	<ul style="list-style-type: none"> <li>- Centre for High National Studies</li> <li>- University Alas Peruanas</li> <li>- Catholic University of Peru</li> <li>- Join Training Centre for Peacekeeping Operations (CECOPAZ)</li> </ul>
<b>Uruguay</b>	<ul style="list-style-type: none"> <li>- High National Studies Centre</li> <li>- Military College of Higher Studies</li> </ul>
<b>Venezuela</b>	<ul style="list-style-type: none"> <li>- Institute for High National Defence Studies</li> </ul>

Source: Information by the above mentioned institutions.

### Number of Applicants to Officers Academies (2008 - 2010)

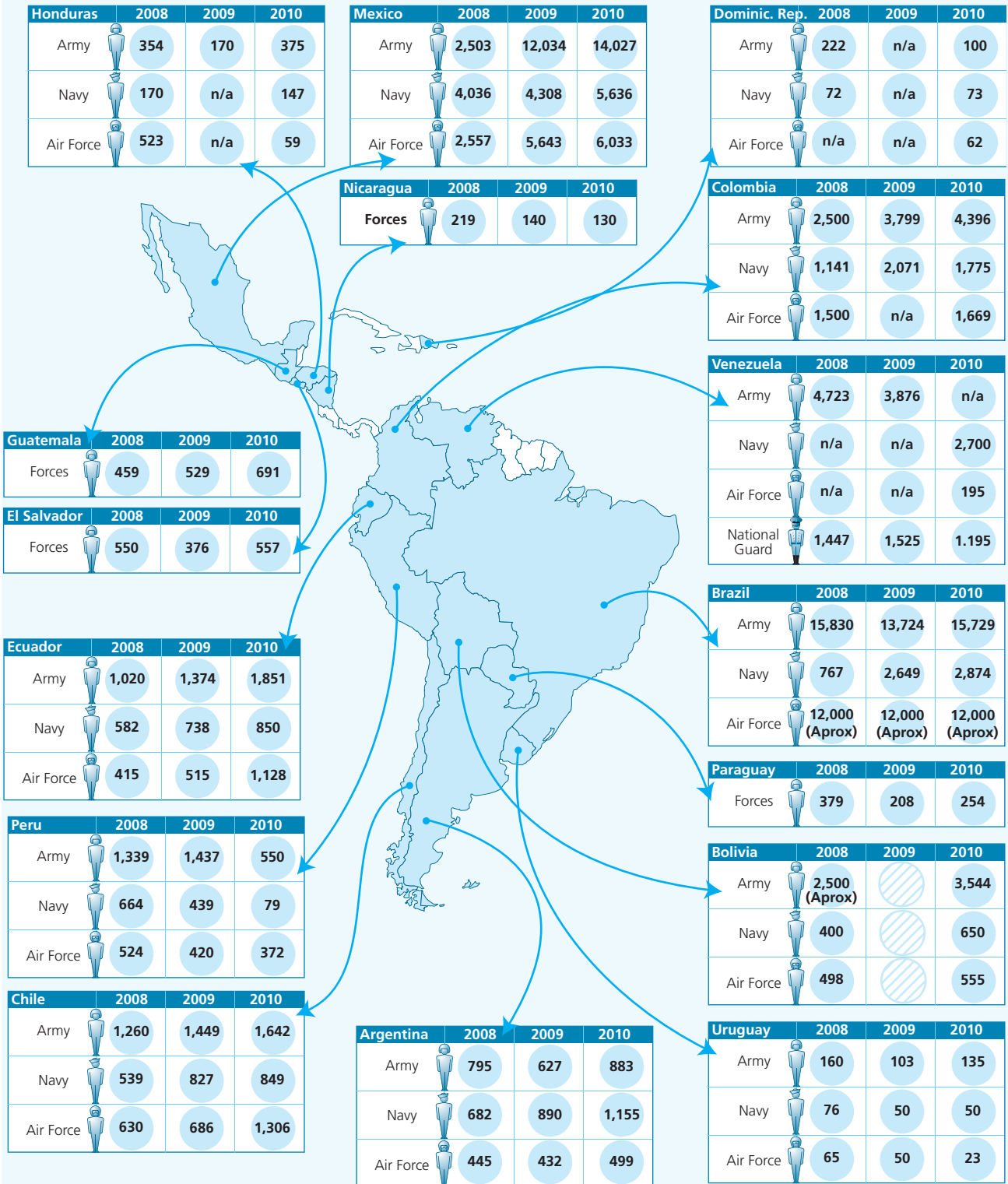

No callup of candidates was made that year. Not available

**Source:** Ministry of Defence and Military Academy (Colegio Militar) (Argentina). National Army, Military Naval School and Military Aviation College (Bolivia). Military Academy, Navy of Brazil and Air Force (Brazil). Ministry of Defence (Chile). Military School, Naval School and Military Aviation School (Colombia). Military Academy, Naval Academy and Air Academy (Dominican Republic). Ministry of National Defence (Ecuador). Ministry of National Defence (El Salvador). Ministry of National Defence (Guatemala). Army, Naval Force and Air Force (Honduras). National Defence Secretariat and Navy Secretariat (Mexico). Centre of Higher Military Studies (Nicaragua). Ministry of National Defence (Paraguay). Military School, Naval School and Air Force Officers' School (Peru). National Army, National Navy and Uruguayan Air Force (Uruguay). Naval School, Military Aviation School and National Guard Training School (Venezuela).



## Number of Applicants and Admitted Candidates to Officers Academies (year 2010)

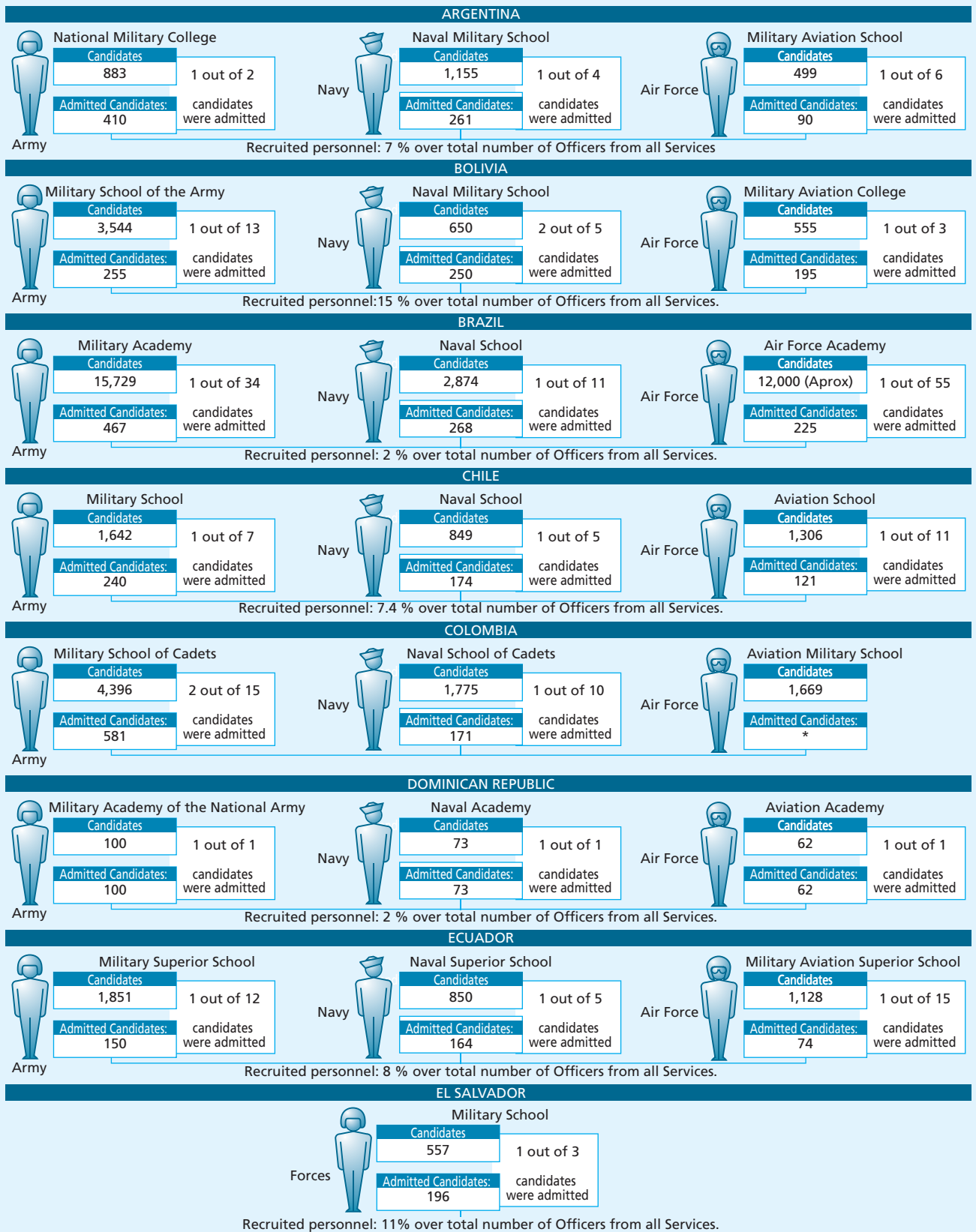

\* As of September 2010, the admission process had not finished.  
**Source:** Ministry of Defence and Military Academy (Colegio Militar) (Argentina). National Army, Military Naval School and Military Aviation College (Bolivia). Military Academy, Navy of Brazil and Air Force (Brazil). Ministry of Defence (Chile). Military School, Naval School and Military Aviation School (Colombia). Military Academy, Naval Academy and Air Academy (Dominican Republic). Ministry of National Defence (Ecuador). Ministry of National Defence (El Salvador). Ministry of National Defence (Guatemala). Army, Naval Force and Air Force (Honduras). National Defence Secretariat and Navy Secretariat (Mexico). Centre of Higher Military Studies (Ni-

**GUATEMALA**

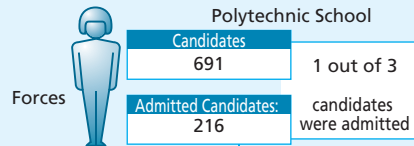

Recruited personnel: 11.1 % over total number of Officers from all Services.

**HONDURAS**

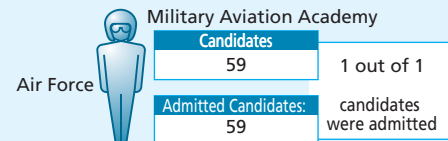
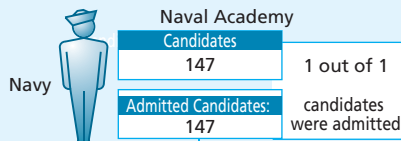
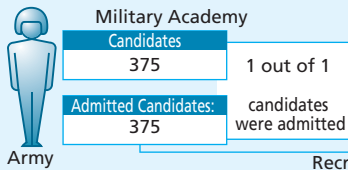

Recruited personnel: 64 % over total number of Officers from all Services.

**MEXICO**

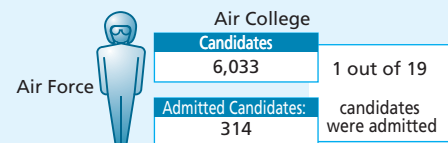
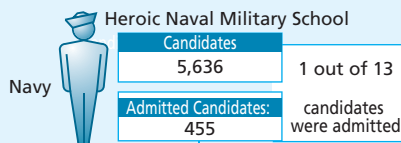
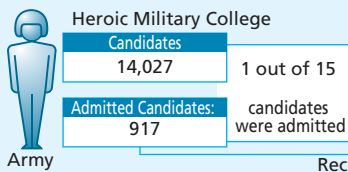

Recruited personnel: 3 % over total number of Officers from all Services.

**NICARAGUA**

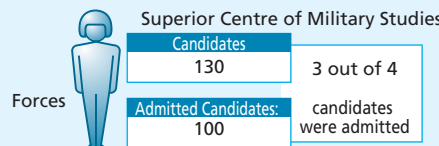

Recruited personnel: 7 % over total number of Officers from all Services.

**PARAGUAY**

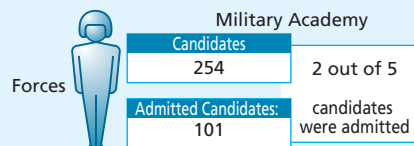

Recruited personnel: 4 % over total number of Officers from all Services.

**PERU**

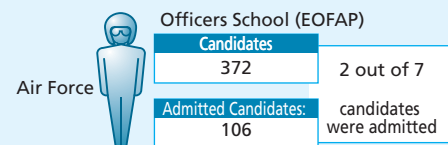
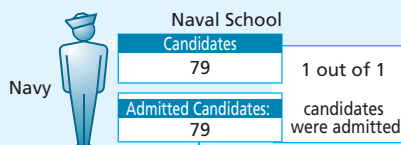
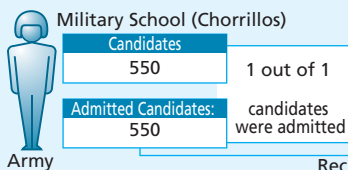

Recruited personnel: 7 % over total number of Officers from all Services.

**URUGUAY**

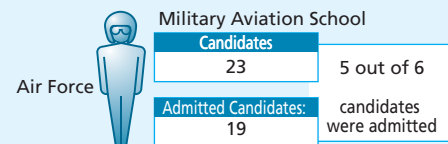
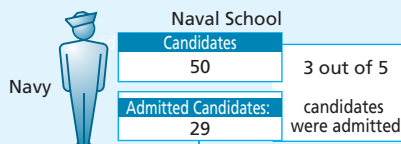
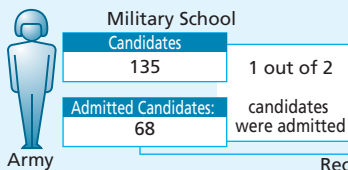

Recruited personnel: 4% over total number of Officers from all Services.

**VENEZUELA**

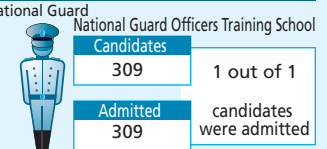
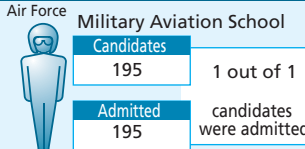
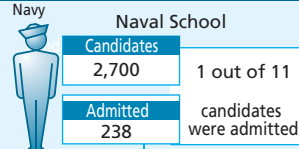
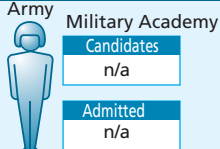

caragua). Ministry of National Defence (Paraguay). Military School, Naval School and Air Force Officers' School (Peru). National Army, National Navy and Uruguayan Air Force (Uruguay). Naval School, Military Aviation School and National Guard Training School (Venezuela).and Military Aviation Academy (Honduras). Secretary of National Defence and Secretary of the Navy (Mexico). Army of Nicaragua (Nicaragua). Ministry of Defence (Paraguay). Ministry of Defence (Peru). National Army, National Navy and Uruguayan Air Force (Uruguay). Military Academy, Naval School, Military Aviation School and Training School of the National Guard (Venezuela).





## Analysis

# Professional Military Education

**Thomas C. Bruneau**

*Center for Civil – Military Relations, Monterey, California*

I believe there is generally little in the U.S. experience of national security & defence and civil – military relations that is relevant to Latin America. And I have this opinion for at least five reasons: First, the U.S. is a well – established democracy, and has been for most of its history. Second, the U.S. with a defence budget of almost \$700 billion in 2010, and 4% of GDP, commits a sum equal to the next fourteen countries for national security and defence. Third, the U.S. is a global power and is highly bureaucratized, with an enormous Department of Defence that consists of 1,421,731 million active duty members within the four services, 2,646,658 civilian personnel, and 463,084 in the Army and Air Force National Guard.<sup>1</sup> Fourth, given the system of represen-

tation, virtually all members of the U.S. Congress have real and concrete electoral incentives to be involved in or conversant with national security and defence. Fifth, with a defence industrial base, even those members of Congress without military bases in their districts, have electoral interests to be involved in issues of national security and defence. This combination of factors suggests that most of the defence institution structure and process don't have much in common with Latin American countries.

The U.S. experience in reforming professional military education (PME), however, is relevant, and for a number of reasons. First, PME was reformed as an integral part of a larger reform effort, and there are lessons that can be drawn from the experience relevant to other countries. The reform was part of the Goldwater – Nichols Defence Reorganization Act of 1986 (G-N), which was the last successful reform in U.S. national security and defence. Second, the reformers behind the reform explicitly saw PME as a way to change the profession in order to increase the combat effectiveness of the armed forces and to reinforce the authority of civilians in decision – making in national security and defence. Third, the PME reforms, and their impact, prove that the profession in the U.S., in contrast to the assumption in Samuel Huntington's *The Soldier and the State*, can be changed. Huntington's classic book is not

<sup>1</sup> Specifically, there are 552,425 personnel in the Army; 330,703 in the Navy; 204,261 in the Marines; and 334,342 in the Air Force. Department of Defense, Military Personnel Statistics, "Active Duty Military Personnel by Rank/Grade, August 31, 2009", <http://siadapp.dmdc.osd.mil/personnel/MILITARY/rg0908.pdf>. For the data on civilians: Department of Defense, Dod Personnel and Military Casualty Statistics, "Civilian Personnel", <http://siadapp.dmdc.osd.mil/personnel/CIVILIAN/CIVTOP.HTM>. And for the National Guard see Michael Waterhouse and JoAnne O'Bryant "National Guard Personnel and Deployments: Fact Sheet," *CRS Report for Congress*, (Washington D.C.: The Library of Congress, 2008). For further data on the armed services see Department of Defense, Office of the Undersecretary of Defense, Personnel and Readiness, "Population Representation in the Military Services", <http://prhome.defense.gov/MPP/ACCESSION%20POLICY/poprep2005/contents/contents.html>

only based on a tautology, but is clearly wrong regarding the unchanging nature of military professionalism in the U.S.<sup>2</sup> If, through PME, the culture of the military profession can be changed in the U.S., there is little reason why it cannot be changed elsewhere, given political will. I would go further and state that if countries in Latin America want to reform their national defence and security structures, they, as the US, will discover that they also must reform PME.

While the G-N Act's primary method to strengthen the joint elements of the military was to change organizations and their responsibilities, PME, however, was expected to play a central role. "Education is important both for learning facts and for affecting attitudes and values. Specifically, joint education can broaden an officer's knowledge beyond his own military service to joint, multi-service matters and can help the officer develop a joint perspective. The Act would enhance joint education both to meet the increased responsibilities of the joint elements and provide officers with joint perspectives. Education on joint matters is a basic link between a service competent officer and a joint competent officer. Further, joint education is a major way to change the professional military culture so that officers accept and support the strengthened joint elements."<sup>3</sup>

Or, as Arch Barrett, who along with James Locher was the main staff in the U.S. Congress behind G-N communicated to me- the staff of the Panel saw changes in education as the means to change the culture of the organization of the U.S. armed forces.<sup>4</sup> However,

2 In *The Soldier and the State: The Theory and Politics of Civil-Military Relations*, Huntington traces the development of U.S. military professionalism up to the Cold War. He then allows no possibility for future evolution. Rather, he focused on how American culture might change to match the military professionalism. His most famous student, Peter Feaver, recognizes the tautology of Huntington's central argument: "The heart of his concept is the putative link between professionalism and voluntary subordination. For Huntington, this was not so much a relationship of cause and effect as it was a definition: 'A highly professional officer corps stands ready to carry out the wishes of any civilian group which secures legitimate authority within the state'. A professional military obeyed civilian authority. A military that did not obey was not professional." Peter D. Feaver, *Armed Servants: Agency, Oversight, and Civil-Military Relations*, (Cambridge, MA: Harvard University Press, 2003), 18.

3 United States. Congress House, Committee on Armed Services, Panel on Military Education, *Report of the Panel on Military Education of the One Hundredth Congress of the Committee on Armed Services*, House of Representatives: One Hundred First Congress, first session, (Washington, D.C.: G.P.O., 1989), 11-12.

4 Arch Barrett, e-mail communication to the author, November 28, 2001.

as Barrett also pointed out, legislation is not self-implementing. Despite the item on "establishes a joint officer personnel system" in the G-N law, it became obvious that the services were not seriously establishing a joint officer personnel system nor providing the education to support it. Thus, two years after G-N was enacted, the House Armed Services Committee created the Panel on Military Education of the One Hundredth Congress to investigate PME and to make recommendations. Congressman Ike Skelton became the PME Panel Chairman.

The Skelton Panel was the first systematic study of PME in 200 years. Through extensive hearings and visits to the main higher - level military educational institutions, the Panel arrived at a number of conclusions that resulted in nine recommendations. All of these led in the direction of a higher quality, more intensive and robust, system of PME, including Joint PME.<sup>5</sup>

Subsequent high - level studies have generally found that the PME goals of Goldwater-Nichols are being achieved. The Cheney report notes a 1991 General Accounting Office study indicating that 90% of Skelton Panel's recommendations had been achieved.<sup>6</sup> The reformers of the institutions of U.S national security and defence realized that the institutions would not work as intended without educational change. They thus invested a huge amount of political energy and time in reforming the U.S. military educational system. It should be noted that the U.S. Department of Defence "(...) presides over the largest and most expensive educational system in the world."<sup>7</sup> The reformers, in later studies, including the 1997 Cheney study and the 2010 Oversight & Investigations Subcommittee<sup>8</sup>, realized that educational was key to all aspects of control and effectiveness in national security and defence. It must also be noted, however, that it has been difficult to reform PME. It was for this reason that the Congress assigned specific responsibility to the Secretary of Defence, and there is a requirement for an annual report

5 United States. Report of the Panel on Military Education..., 2-7.

6 Richard B. Cheney, *Professional Military Education: An Asset for Peace and Progress. A report of the CSIS Study Group on Professional Military Education*, ed. Bill Taylor, (Washington, D.C.: CSIS, 1997), 64. For more information see Greta E. Marlatt, *A Bibliography of Professional Military Education (PME)*, (Monterrey CA, Dudley Knox Library, Naval Postgraduate School, 2007), [http://edocs.nps.edu/npspubs/scholarly/biblio/Oct07-PME\\_biblio.pdf](http://edocs.nps.edu/npspubs/scholarly/biblio/Oct07-PME_biblio.pdf).

7 Richard B. Cheney, *Professional Military Education...*, vii.

8 United States. House of Representatives, Committee on Armed Services, Subcommittee on Oversight and Investigations, *Another Crossroads? Professional Military Education Two Decades After the Goldwater-Nichols Act and the Skelton Panel*, (Washington D.C.: Committee Print 111-14, 24), note 22 for GAO reports.



to Congress on implementation.

With this background one has to wonder if other countries, lacking a powerful and concerned congress as in the US, can take the initiative in passing a law similar to Goldwater–Nichols, creating a Panel, or requiring annual reports to Congress on implementation. I think that generally the model, or lessons, of the U.S. are not applicable. However, we find that there are ongoing reforms in PME in Canada, Romania, and Spain, which are all members of NATO with fairly specific and standard requirements in defence. There are also some recent innovations in several countries in South America that I wish to highlight here. I have not been able to identify a larger, or more general, movement towards PME reform in Latin America, but rather specific responses to particular national challenges and opportunities. Each PME reform initiative is specific, and thus unique, but worthy of further study and possible expansion to other countries.

As the only country in South America engaged in armed conflict, the government and armed forces in Colombia have increasingly been concerned with PME in terms of the educational background of their officers in order to increase combat effectiveness. As early 2002 they sought support from the Center for Hemispheric Defense Studies (CHDS) and the Center for Civil – Military Relations. More recently, through the U.S. Department of Defence’s Defence Institutions Reform Initiative (DIRI), the Colombian Armed Forces are heavily engaged in a major assessment, and possible reform, of the whole PME system.

Chile undertook major reform in their Military Academy in 2006. The author participated in the first ever accreditation assessment, involving a foreigner, for the Chilean Ministry of Education. During the process of the accreditation visit in October 2006 it became obvious that there were two main motivations for the accreditation. First, Chileans, including the armed forces, are well aware of the challenges of globalization. Therefore, the armed forces need to respond with education, including training in English and other languages, which will prepare the young officers to deal with the challenges, and opportunities, of globalization. Second, due to initiatives in the Ministry of Education, accreditation is required if the cadets want to receive grants and loans for their education. It must be noted that education at the Chilean Military Academy is not free. The cadets have to pay a certain percentage, and the accreditation makes them eligible for these funds. Accreditation of the Military Academy involves

it with other, public and private, universities. While the accreditation of the Military Academy has probably spread to the other, Navy and Air Force, academies, it is slower to spread to the higher level, war colleges, of the services.

In Brazil the armed forces are very much aware of the overall modernization of society and seeking reforms in all areas. For my purposes here the most innovative program is the Pro-Defesa that seeks to break down the barriers between the war colleges and civilian universities through providing funds if civilians and military officers develop joint research and publishing proposals. This initiative responds to the continuing separation in Brazil between most of society and the armed forces, which was certainly aggravated during the military regime of 1964 – 1985. Part of that legacy is a certain stigma among civilian academics and students regarding the armed forces. Through Pro – Defesa civilians are much more involved with military officers and institutions and the officers are studying for advanced degrees.<sup>9</sup>

In Argentina there is a major reform currently underway to reform the whole PME system. The Ministry of Defence created the office of *Subsecretaría de Formación* in 2009 with authority over PME. They have sent assessment teams to seven military academies and entry – level educational institutions, which would then presumably result in recommendations for reform. In addition, they created a totally new Joint Superior War School with a new, one–year, joint curriculum. Sooner or later this new School will have an impact on the current war colleges of the three services.

In short, there are indications of the awareness of civilians regarding the importance of changing PME to achieve fairly country – specific goals in military education. I suspect that once the practical implications of the reforms in Argentina, Brazil, Chile or Colombia are recognized they will spread further within each society, and quite possibly to other countries.

<sup>9</sup> See Brazil. Ministerio da Defesa, “Pro-defesa”, [https://www.defesa.gov.br/pro\\_defesa/](https://www.defesa.gov.br/pro_defesa/)

Chapter 7:

# The Armed Forces

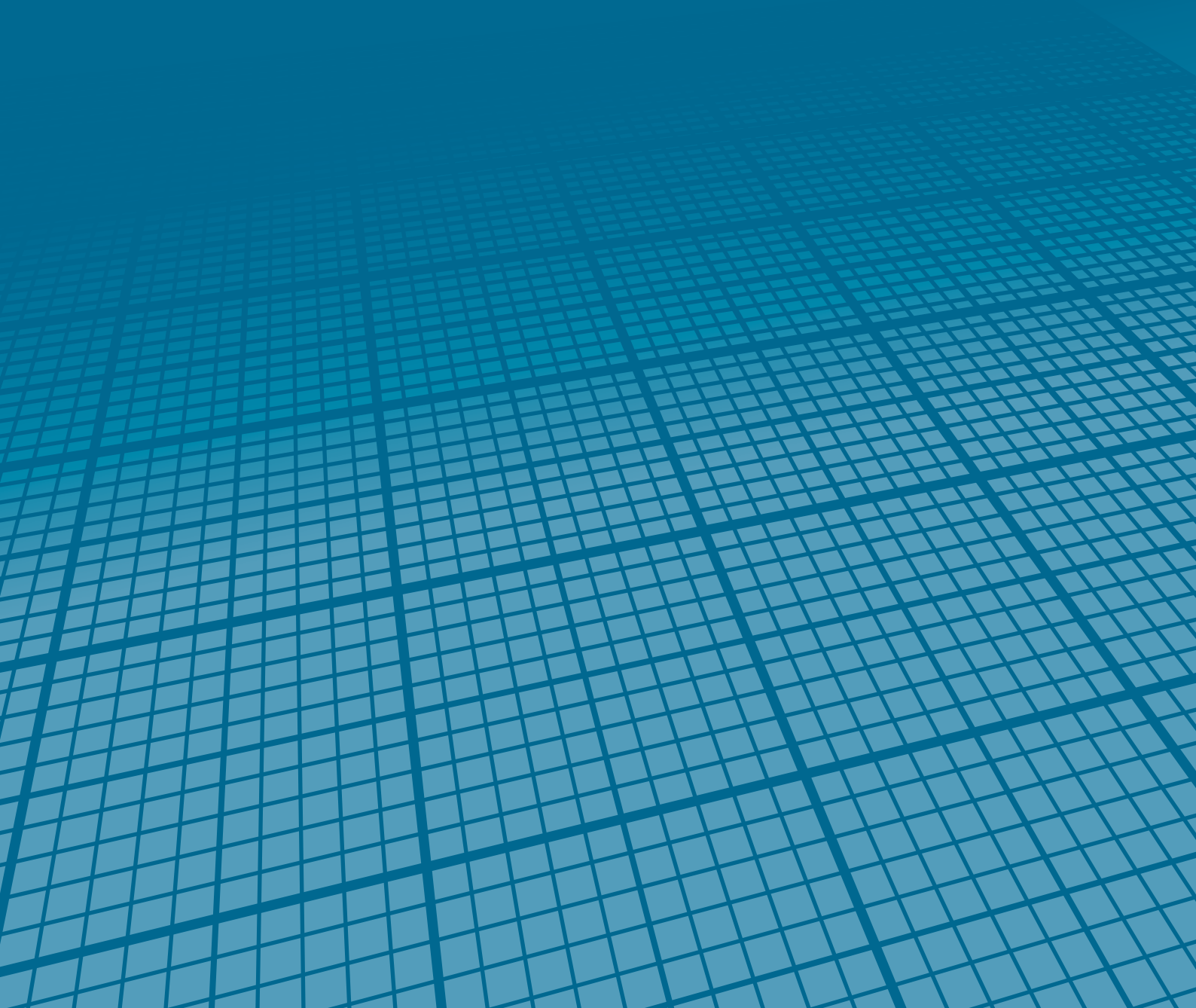



### Armed Forces Strength in 2010



	Army			Navy			Air Force			
<b>Argentina</b>	45,048			18,561			14,051			<b>TOTAL</b> 77,660
	5,748 Officers	21,666 Non-commissioned officers	17,634 Enlisted soldiers	2,474 Officers	14,545 Non-commissioned officers	1,542 Enlisted soldiers	2,403 Officers	10,098 Non-commissioned officers	1,550 Enlisted soldiers	
<b>Bolivia</b>	28,493			5,334			5,665			<b>TOTAL</b> 39,492
	2,883 Officers	4,392 Non-commissioned officers	21,218 Enlisted soldiers	915 Officers	1,549 Non-commissioned officers	2,870 Enlisted soldiers	902 Officers	1,725 Non-commissioned officers	3,038 Enlisted soldiers	
<b>Brazil</b>	222,212			46,956 <sup>1</sup>			64,414			<b>TOTAL</b> 333,582
	26,108 Officers	51,191 Non-commissioned officers	144,913 Enlisted soldiers	7,821 Officers	3,476 Non-commissioned officers	35,659 Enlisted soldiers	9,027 Officers	24,687 Non-commissioned officers	30,700 Enlisted soldiers	
<b>Chile</b>	35,551			18,365			7,935			<b>TOTAL</b> 61,851
	3,825 Officers	16,933 Non-commissioned officers	14,793 Enlisted soldiers	2,211 Officers	15,534 Non-commissioned officers	620 Enlisted soldiers	1,165 Officers	6,182 Non-commissioned officers	588 Enlisted soldiers	
<b>Colombia</b>	226,544			31,355			10,343			<b>TOTAL</b> 268,242
	8,927 Officers	31,544 Non-commissioned officers	186,073 Enlisted soldiers	2,159 Officers	7,888 Non-commissioned officers	21,308 Enlisted soldiers	2,197 Officers	3,338 Non-commissioned officers	4,808 Enlisted soldiers	
<b>Dominican Republic</b>	25,949			10,082			10,141			<b>TOTAL</b> 46,172
	7,781 Officers	18,168 Non-commissioned officers and Troops		2,580 Officers	7,502 Non-commissioned officers and Troops		4,071 Officers	6,070 Non-commissioned officers and Troops		
<b>Ecuador</b>	23,538			7,576			6,070			<b>TOTAL</b> 37,184
	2,844 Officers	20,694 Enlisted soldiers		1,030 Officers	6,546 Enlisted soldiers		835 Officers	5,235 Enlisted soldiers		
<b>El Salvador</b>	12,661			830			771			<b>TOTAL</b> 14,262
	1,444 Officers	820 Non-commissioned officers	10,397 Enlisted soldiers	133 Officers	54 Non-commissioned officers	643 Enlisted soldiers	205 Officers	242 Non-commissioned officers	324 Enlisted soldiers	
<b>Guatemala</b>	13,078			909			919			<b>TOTAL</b> 14,906
	1,652 Officers	3,047 Non-commissioned officers	8,379 Enlisted soldiers	161 Officers	275 Non-commissioned officers	473 Enlisted soldiers	118 Officers	296 Non-commissioned officers	505 Enlisted soldiers	
<b>Honduras<sup>2</sup></b>	6,467			994			1,105			<b>TOTAL</b> 8,566
	526 Officers	109 Non-commissioned officers	5,832 Enlisted soldiers	163 Officers	54 Non-commissioned officers	777 Enlisted soldiers	214 Officers	323 Non-commissioned officers	568 Enlisted soldiers	
<b>Mexico</b>	198,311			52,426			7,702			<b>TOTAL</b> 258,439
	37,448 Officers	168,565 Non-commissioned officers		12,807 Officers	26,233 Non-commissioned officers	13,386 Enlisted soldiers	Desaggregation includes within Army data			

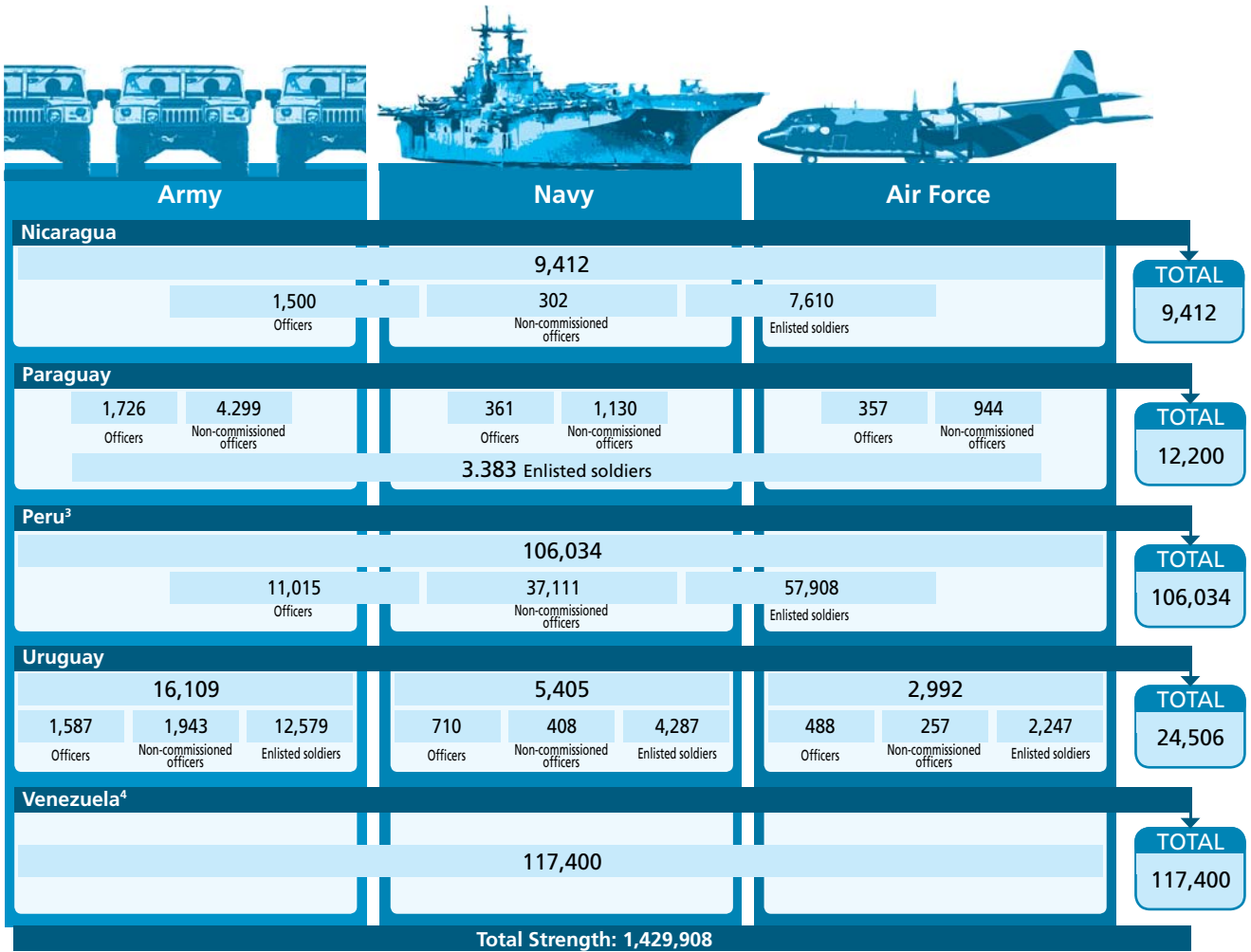

- 1. The marine corps members (fuzileiros) are not included.
- 2. Data for 2009.
- 3. Data for 2009.
- 4. Includes the National Guard.

Number of regular Force members every 10,000 inhabitants

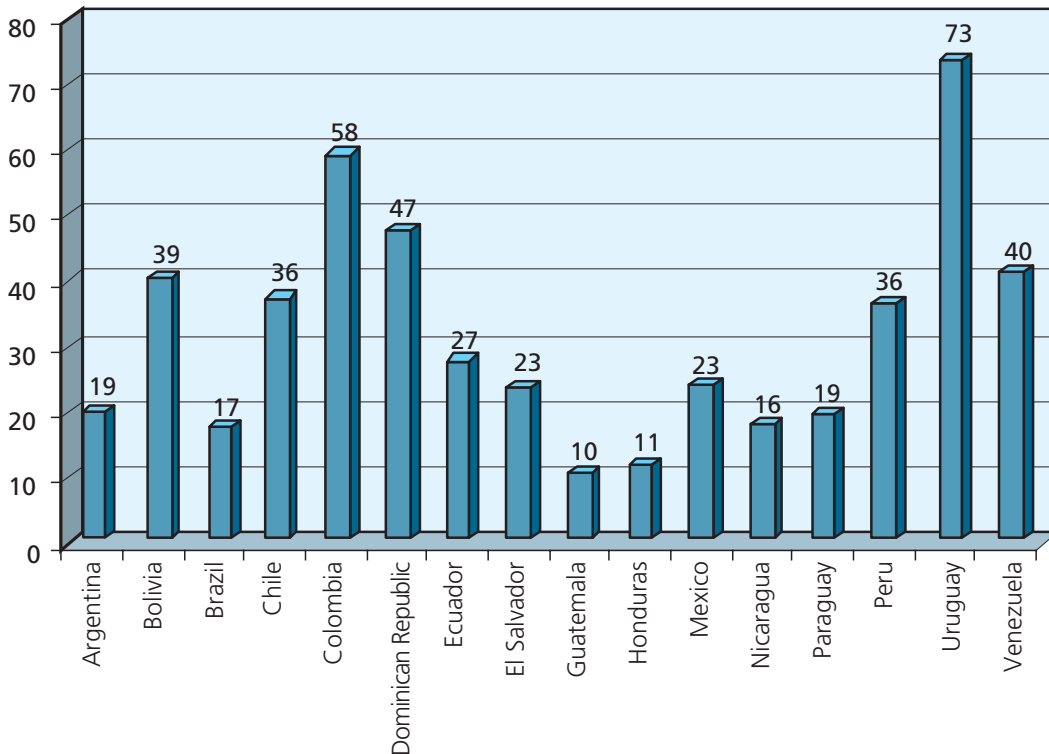

Source: Agencies and official documents specified in section "The countries" for this publication. Information on population provided by the Statistical Yearbook for Latin America and the Caribbean, 2009, ECLAC (Population Forecast 2010).



## Military Cooperation

Military cooperation in the region is materialized in the ongoing and regular conduct of combined exercises, both of a bilateral and multilateral nature, where the goal is to enhance greater interoperability among forces while contributing to the strengthening of confidence-building between nations. Such exercises, in many instances include in addition to military training, the conduct of natural disaster response drills, multidimensional scenarios under UN mandate, search and rescue situations, and combat of illicit trafficking, among others.

### Bilateral Exercises

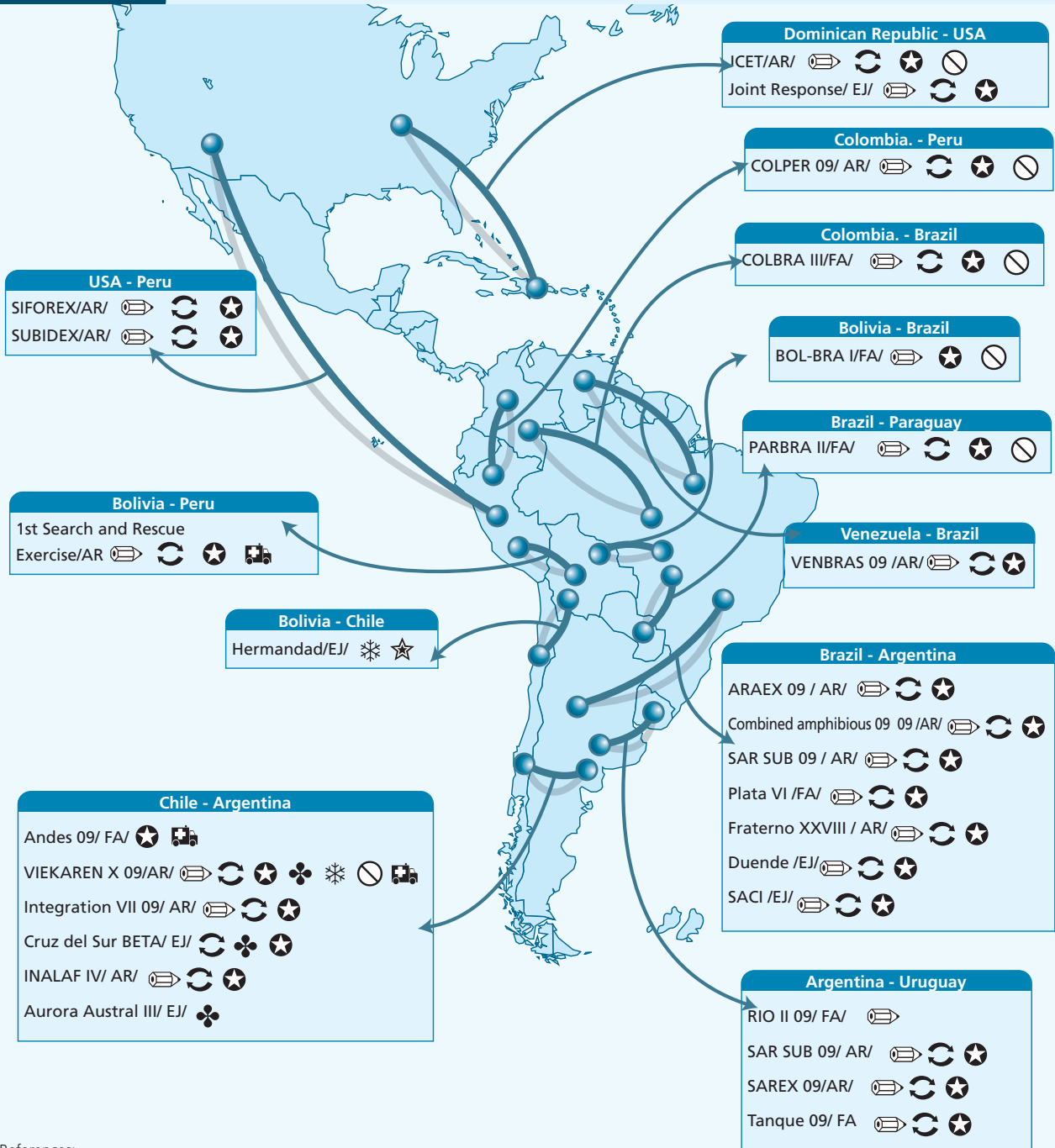

















































References:

EJ: Army	[Training icon]: Training	[Force deployment icon]: Force deployment	[Drills icon]: Drills	[OMP icon]: OMP
AR: Navy	[Information and procedure exchange icon]: Information and procedure exchange	[Illicit trafficking icon]: Illicit trafficking	[Natural disasters icon]: Natural disasters	[Search and rescue icon]: Search and rescue
FA: Air Force	[Force deployment icon]: Force deployment			

Source: Compilation based on information provided on the websites of the legislative bodies, Ministries of Defence and Armed Forces of the participating countries.

## Multilateral Exercises

Exercise	Type of Exercise	Force	Participants
ACRUX 2009	  	Navy	Argentina, Bolivia, Brazil, Paraguay, Uruguay.
PANAMAX 2009	  	Navy, Army	Argentina, Belize, Brazil, Canada, Chile, Colombia, Costa Rica, Dominican Republic, Ecuador, El Salvador, France, Guatemala, Netherlands, Nicaragua, Mexico, Panama, Paraguay, Peru, United States, Uruguay.
Multinational Alliance Operation	  	Navy	Brazil, Chile, Colombia, Peru, United States.
UNITAS 50 GOLD	  	Navy	Argentina, Brazil, Canada, Chile, Colombia, Dominican Republic, Ecuador, France, Germany, Mexico, Peru, Uruguay, United States.
Salitre 2009	  	Air Force	Argentina, Brazil, Chile, France, United States.
Team Work South	  	Navy	Brazil, Chile, France, United Kingdom, United States.
SOUTHERN EXCHANGE 2009	  	Navy	Argentina, Brazil, Chile, Colombia, Peru, United States, Uruguay
INTEGRATION	  	Army	Argentina, Bolivia, Brazil, Chile, Colombia, Ecuador, Paraguay, Peru, Uruguay, Venezuela.
VII Multilateral War Exercise	   	Navy	Argentina, Brazil, Canada, Chile, Ecuador, Peru, United States.
TRANSOCEANIC XXIV	  	Navy	Argentina, Brazil, Chile, Colombia, Ecuador, Mexico, Paraguay, Peru, South Africa, United States, Uruguay, Venezuela.
Transamerica VII	  	Navy	Argentina, Brazil, Chile, Colombia, Ecuador, Mexico, Paraguay, Peru, United States, Uruguay, Venezuela.
Military Exercise	   	Navy	Colombia, Honduras, United States.
AMERICAS 09	   	Navy, Army, Air Force	Argentina, Belize, Brazil, Canada, Chile, Colombia, Dominican Republic, Ecuador, El Salvador, Guatemala, Honduras, Nicaragua, Paraguay, Peru, United States, Uruguay.
Southern Star	   	Army, Air Force	Brazil, Chile, Paraguay, United States, Uruguay.
Exercise for assistance in the event of disaster	   	Army	Argentina, Bolivia, Brazil, Chile, Colombia, Ecuador, Paraguay, Peru, Uruguay, Venezuela.
FAHUM	   	Navy	Costa Rica, Dominican Republic, El Salvador, Guatemala, Honduras, Nicaragua, Panama, United States.
International Military Patrol Competition		Army	Argentina, Canada, Chile, Ecuador, Paraguay, United Kingdom, United States.
2009 Command Forces		Army	Argentina (Gendarmerie), Barbados, Belize, Brazil, Chile, Colombia, Costa Rica, Dominican Republic, Ecuador, El Salvador, Guatemala, Guyana, Honduras, Jamaica, Mexico, Nicaragua, Panama, Paraguay, Peru, Trinidad and Tobago, United States, Uruguay.

**In 2007, during the XLVII CONJEFAMER (Conference of Air Chiefs of the Americas), the conduct of an exercise was agreed for the integrated response to natural disaster events. Thus, "COOPERACIÓN I" Exercise was designed, to be conducted in October 2010, with Chile as the host country. The Air Forces of Argentina, Bolivia, Brazil, Canada, Colombia, Chile, Dominican Republic, Ecuador, Panama (National Air Naval Service), Paraguay, Peru, United States and Uruguay take part. The Exercise is based on quick and predefined deployment of the aircraft to a disaster area, followed by a short force training and integration period. The goal is to contribute to the standardization of procedures and the definition of a common action methodology for the Air Forces of the Americas to be able to act promptly and effectively in the event of an emergency.**

Argentina-Chile "CRUZ DEL SUR" Combined Joint Peace Force  
In December 2005, the Ministers of Defence of the Republic of Argentina and the Republic of Chile signed a bilateral agreement for the purpose of setting up the Argentine-Chilean Combined Peace Force "CRUZ DEL SUR." This project comprised the creation of a rapid deployment force under the UNSAS (United Nations Stand By Arrangement System)- with the capability to deploy within a 30/90 day period from the time the UN Security Council Resolution is passed until the deployment of a generic peacekeeping and stabilization mission; and with a self-sustaining capacity in the area for 90 days. In October 2008, the Ministers of Defence of Republic of Peru and the Republic of Argentina agreed on the creation of the Binational "Libertador Don José de San Martín" Company of Engineers intended for the joint construction of infrastructure work needed by the Haitian people within the framework of the MINUSTAH, a mission in which both countries already have military personnel deployed. A similar initiative was the creation of the Combined Chilean - Ecuadorian Company of Horizontal Construction Engineers, a unit that has been operating since 2009.

**Sources:** Compilation based on websites of the Ministry of Defence of Argentina, National Defence Staff of Chile, and the Joint PKO Center of Chile (CECOPAZ). *Memorandum de Entendimiento Fuerza de Paz Combinada Argentino-Chilena "Cruz del Sur"*, 2006. *Memorandum de Entendimiento Fuerza de Paz Combinada Argentino-Peruana "Libertador Don José de San Martín"*, 2008. Website of the legislative bodies, Ministries of Defence and Armed Forces of the participating countries. More information on Chapter 9.





## Women's Admission to the Armed Forces (year)

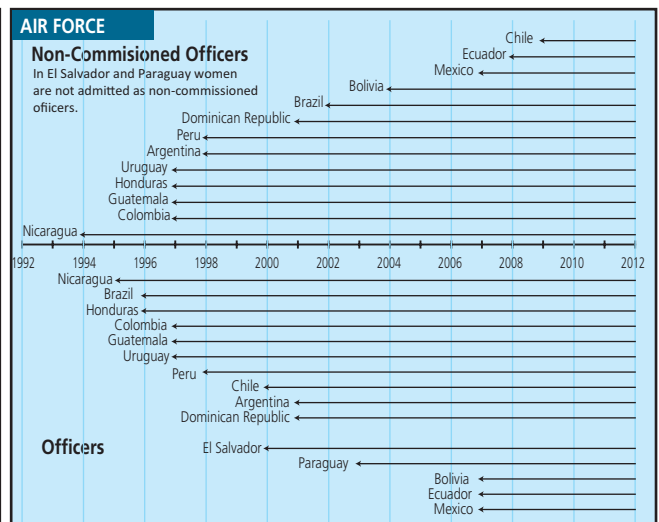
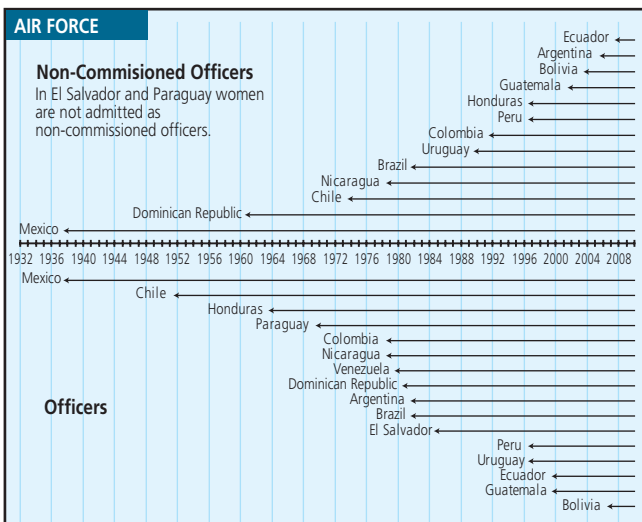
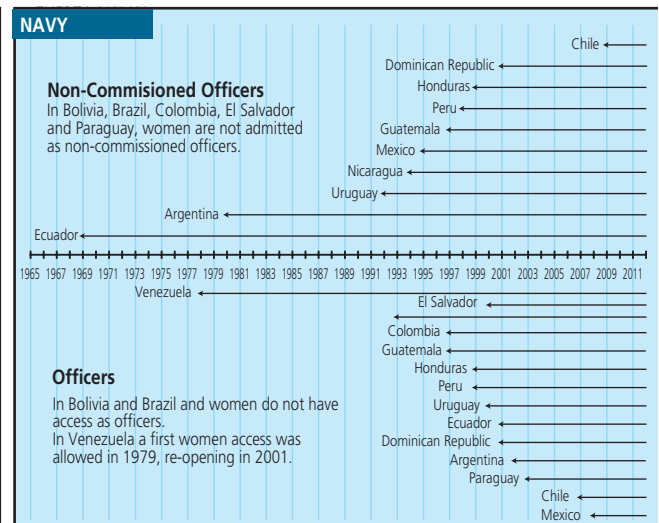
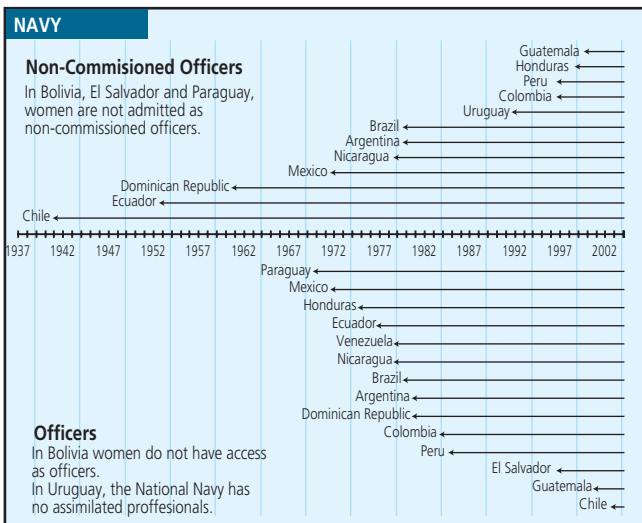
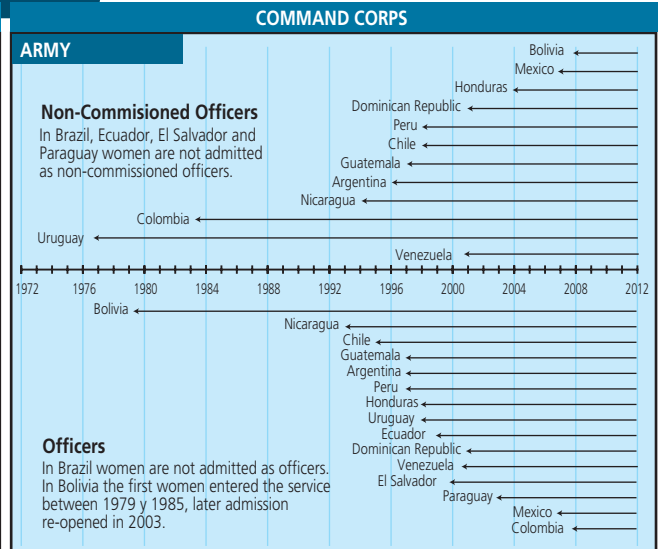
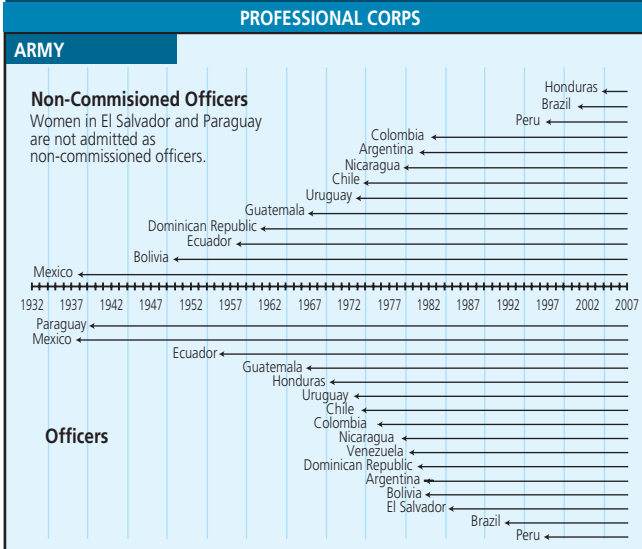

**Note:** The Command corps includes officers who have been educated at military academies from the beginning of their professional careers. The Professional corps refers to those who develop a career in the civilian sphere and are then incorporated to the armed forces. In Venezuela the admission of women into the National Guard was 1970 for the Staff corps and 2001 for the Command corps.

Women Officers who have reached the Highest Rank in the Command Corps (2010)

ARMY

Company-grade Officers

- Argentina: First Lieutenant
- Chile: Lieutenant
- Colombia: Second Lieutenant
- El Salvador: Lieutenant
- Honduras: Captain
- Paraguay: Lieutenant
- Peru: Lieutenant
- Uruguay: First Lieutenant
- Venezuela: Captain

Staff-grade Officers

- Bolivia: Colonel\*
- Ecuador: Major
- Guatemala: Colonel\*\*
- Nicaragua: Lieutenant Colonel

\* Current Colonels graduated from the first promotion of the Officers Academy (1979-1985).  
 \*\* Colonels are health specialist officers from the service branch. There are no active women in the command corps.  
 \*\*\* Generals belong to the professional corps.

Senior-grade Officers

- Cuba: Brigadier General
- Dominican Republic: Brigadier General
- Mexico: Brigadier General\*\*\*

NAVY

Company-grade Officers

- Argentina: Lieutenant JG
- Colombia: Lieutenant
- El Salvador: Lieutenant
- Guatemala: Second Lieutenant
- Honduras: Lieutenant
- Peru: Second Lieutenant
- Paraguay: Lieutenant JG
- Uruguay: Navy Second Lieutenant

Staff-grade Officers

- Dominican Republic: Commander
- Ecuador: Captain
- Mexico: Commander\*
- Peru: Lieutenant-commander

Note: In Chile women are currently in their 4th year of training. In El Salvador as for 2010 they are in their 3rd year of training. In Mexico commanders are women officers from the professional corps.

Senior-grade Officers

- Venezuela: Vice-Admiral

AIR FORCE

Company-grade Officers

- Argentina: Lieutenant
- Chile: Lieutenant
- Colombia: Captain
- Ecuador: Captain
- El Salvador: Lieutenant
- Honduras: Captain
- Guatemala: Lieutenant
- Paraguay: Lieutenant
- Peru: Lieutenant
- Uruguay: Captain

Staff-grade Officers

- Brazil: Lieutenant-Colonel
- Dominican Republic: Captain\*

\* According to the officers classification they belong to Intermediate Officers category.  
 \*\*Generals are women officers from the professional corps.  
 Note: In the case of Bolivia, women officers are in the 4<sup>o</sup> year of instruction.  
 Information about Cuba is not available.

Senior-grade Officers

- Mexico: Brigadier General\*\*
- Venezuela: Major General

Admission of Women into Military Training Specialties (Officers, command corps)

Country	Admission level sorted by corps and specialty		
	Army	Navy	Air Force
1. Argentina	Partial	Total	Total
2. Bolivia	Total	No access	Total
3. Brazil	No access	No access	Partial
4. Chile	Partial	Partial	Total
5. Colombia	Total	Total	Total
6. Cuba	n/a	n/a	n/a
7. Dominican Republic	Partial	Partial	Partial
8. Ecuador	Partial	Partial	Partial
9. El Salvador	Partial	Partial	Partial
10. Guatemala	Partial	Total	Total
11. Honduras	Partial	Total	Total
12. Mexico	Partial	Partial	Partial
13. Nicaragua	Total	Total	Total
14. Paraguay	Partial	Partial	Partial
15. Peru	Partial	Partial	Partial
16. Uruguay	Total	Total	Total
17. Venezuela	Total	Total	Total

1. No access to infantry or cavalry in the land force.
  2. No access to infantry or first class technician.
  3. No access to infantry, armoured cavalry in the land force; to marine corps and its specialties on material, submarines, tactical diving, rescue diving and lighthouses in the naval force.
  4. No access to infantry, armoured cavalry in the land force; to marine corps and its specialties on material, submarines, tactical diving, rescue diving and lighthouses in the naval force.
  5. No access to combat related specialties.
  6. No access to combat related specialties.
  7. No access to combat related specialties.
  8. No access to infantry, armoured cavalry or aviation in the land force, to submariners and naval aviation in the naval force, or to paratrooper corps, helicopter pilot, special operation, air combat control or liaison officer positions in the air force.
  9. No access to combat-related specialties.
  10. No access to artillery, engineering or cavalry in the Army.
  11. No access to artillery, infantry or cavalry in the Army.
  12. No access to combat-related specialties.
  13. No access to infantry, cavalry or artillery in the Army; submarines, infantry, special operations, diving or rescue in the Navy; or combat pilot, air defence or special operations positions in the Air Force.
  14. No access to artillery, cavalry or religious services in the Army; to submarine crew, intelligence or special operation forces in the Navy, nor to combat pilot or intelligence in the Air Force.
  15. No access to artillery, cavalry or religious services in the Army; to submarine crew, intelligence or special operation forces in the Navy, nor to combat pilot or intelligence in the Air Force.
  16. No access to artillery, cavalry or religious services in the Army; to submarine crew, intelligence or special operation forces in the Navy, nor to combat pilot or intelligence in the Air Force.
  17. No access to artillery, cavalry or religious services in the Army; to submarine crew, intelligence or special operation forces in the Navy, nor to combat pilot or intelligence in the Air Force.
- n/a: not available.

Percentage of women in the Armed Forces

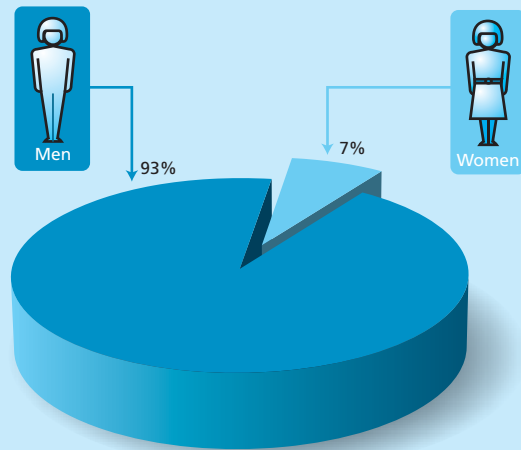

Note: it includes officers, NCO's and enlisted troops. The graph does not include Brazil, Dominican Republic and Nicaragua.

Source: Data gathered through interviews with Army Officers and the Ministry of Defence (Argentina). Directorate of Human Rights and Interculturality of the Ministry of Defence (Bolivia). websites of the Armed Forces (Brazil). Personnel Directorates of the Army, Navy and Air Force (Chile). Ministry of Defence and National Navy (Colombia). Directorate of Human Rights of the Ministry of Defence (Ecuador). Ministry of Defence and Peacekeeping Operations Training Institute of the Armed Forces (El Salvador). Ministry of National Defence (Guatemala). General Command of the Air Force, General Command of the Naval Force and Joint Chief of Staff of the Armed Forces (Honduras). Memoria 1979-2009 (Army of Nicaragua). Secretary of the National Defence and Secretary of the Navy (Mexico). Ministry of National Defence (Paraguay). Human Resources Directorate of the Ministry of Defence (Peru). Third Department of the Army General Staff, National Army and Uruguayan Air Force Public Relations Directorate, National Peacekeeping Operations Training Centre and Navy General Staff (Uruguay). Ministry of the Popular Power for the Defence (Venezuela). Project 07-184 Global Peace and Security Fund - RESDAL.



## Military Service

### Reserve

Mexico and Cuba are the only cases with a reserve corps system in place. In Mexico, recruitment in the Army and Air Forces is done in two ways: **voluntarily** or through **conscription** (NMS).

NMS Personnel Non-commissioned officers in 2009.	NMS Personnel recruited in 2009.	
	Enlisted	Reserve
511,999	63,980	363,262

The number of candidates who entered the ground and air forces voluntary military service in 2009 was 13,359.

### Professional soldiers

In Chile, the professional enlisted soldiers reached the number of 3,703 members of staff in 2009. In 2010, the system was also made available to the Air Force. The number of professional soldiers is estimated to reach 5,000.



### Voluntary – conscription system relationship

According to the Guatemalan Civil Service Act, all the citizens of Guatemala have the right and the responsibility to provide service to their country. During the first stage, participation shall be voluntary. If the numbers expected are not reached, the general practice is to conduct a draw. The summon prior to the mandatory call can equal or exceed the available vacant places. For instance, in 2009 the total amount of conscripts in Chile joined the military service on a voluntary basis.

The following data belongs to Guatemala:

Guatemala (2009)	
Entered	Discharged
6,438 (Enlisted soldiers)	6,180 (Enlisted soldiers)
107 (experts)	80 (experts)

**In countries where military service is mandatory, men always have to serve while women may do so voluntarily in times of peace or be drafted in the event of war or emergency.**

	1 year	2 years	3 years	4 years
<b>Mandatory</b>	<b>Brazil:</b> 1 year. <b>El Salvador:</b> 1 year. <b>Mexico:</b> 1 year. <b>Paraguay:</b> 1 year. <b>Venezuela:</b> 1 year.	<b>Bolivia:</b> 2 years. <b>Chile:</b> up to 2 years. <b>Colombia:</b> 1 to 2 years. <b>Cuba:</b> 2 years. <b>Guatemala:</b> up to 18 months.		
<b>Voluntary</b>	<b>Ecuador:</b> 1 year. <b>Nicaragua:</b> 1 year.	<b>Argentina:</b> 2 years. <b>Honduras:</b> 2 years. <b>Peru:</b> Up 2 years. <b>Uruguay:</b> 2 years..		<b>Dominican Republic:</b> 4 years.

### Conscription

El Salvador (2009)		
	Candidates	Admitted Candidates
Ground Force	1,613	224
Air Force	74	0
Naval Force	92	67

Brazil (2009)	
	Admitted Candidates
Ground Force	61,610
Air Force	6,553
Naval Force	3,131

Paraguay (2009)	
Total	3,927

### Geographical Distribution of the Recruited Persons

Bolivia (2009)	
La Paz	11,261
Potosí	1,101
Oruro	2,040
Tarija	714
Santa Cruz	3,840
Beni	1,287
Cochabamba	6,950
Chuquisaca	682
Pando	58
<b>TOTAL</b>	<b>27,933</b>

### Women in the Military Service

All the countries of the region with a voluntary military service regime allow both men and women to be candidates. Some examples are:

Argentina (Ground Force - 2009).			
Men		Women	
Candidates	Admitted Candidates	Candidates	Admitted Candidates
9,038	5,276	2,711	748

Chile (Ground Force - 2009)			
Candidates		Admitted candidates	
Women	7,531	Women	1,200
<b>TOTAL</b>	<b>32,297</b>	<b>TOTAL</b>	<b>13,608</b>

Argentina (Admitted Candidates – Ground Force 2009)	
Buenos Aires: Azul / Tandil / Mar del Plata / City Bell / Bahía Blanca	459
Región Metropolitana: Campo de Mayo / CABA	1,111
Entre Ríos	484
Salta / Jujuy / La Rioja / Tucumán	354
Neuquén / Río Negro	442
Mendoza / San Luis / San Juan	445
Chubut	271
La Pampa	357
Santa Cruz	720
Formosa / Chaco / Corrientes / Misiones	278
Santa Fe / Corrientes	404
Córdoba / Santiago del Estero	717

Source: Legislation regulating the military service in the different countries. Data: Ministries of Defence of the corresponding countries.

## Analisis

# Military Organization and Force Design

## Jaime García Covarrubias

*Professor of National Security Affairs - Centre  
for Hemispheric Defence Studies*

The concept of military “transformation” emerged in the United States in the 1970s, when Generals Starry and Morelli, with Alvin Toffler’s prospective advice, started to think about the type of war that would be waged by the end of industrial society, in an age dominated by cybernetics with a strong technological component. Their conclusion was clear: the new type of war required a military force with sophisticated armament, more qualitatively than quantitatively equipped, with personnel with higher intellectual preparation. However, the word “transformation” was not formally adopted at that time.

It would be the Bush administration that placed emphasis on the project. Soon after the inauguration of the Republican government a Force Transformation Office was created within the Department of Defence. The process began in 2001, but it was also hit by the impact of international contingencies. Indeed, after the attack on the Twin Towers, it focused on the fight against terrorism and the lessons learnt in the Iraq War. In this new scenario, it became clear that excessive technology and qualitative forces did not necessarily guarantee success. Discordant voices were heard from high-ranking military officers, both in active service and retired. Later on, after the Rumsfeld resignation, the Force Transformation Office (based in Norfolk) was dissolved and all its activities distributed to differ-

ent structures within the Department of Defence.

Without attempting, for reasons of space, a complete analysis of the subject, it is worth underscoring the so-called *Network Centric Warfare*. This element was defined as a new “war theory” and constitutes a platform of command, control and employment based on the integration of strategic systems, techniques, emerging tactics, procedures and organizations which give a decisive advantage in war fighting.

The other significant measure was the implementation of inter-agency coordination and the joint employment of State and Defence Departments in operations. The core idea was integrating political and military aspects from the beginning of any conflict. So, while military operations evolve, activities prior to the stabilization and reconstruction phases are conducted in parallel.

Simultaneously, in 2001, the notion of military transformation spread to Latin America, and in 2003 Chile adopted it, when its Modernisation Plan started to focus on transformation. Around that time, something similar was announced in Uruguay, but the initiative did not prosper. In turn, Colombia applied a scheduled renewal process to its armed forces by adopting the joint system but without speaking of transformation with the meaning that was attributed to the term in the US. The rest of the countries did not adhere to



this notion but started to watch closely what was going on in the north. Obviously, certain countries ruled out the model from the outset owing to its high technological demands and its inapplicability in countries ranking low among national powers. This means that there was no regional consensus on the matter which did not elicit more than initial curiosity. The expression “military transformation” disturbed and perhaps even confused the natural intentions in military renewal and reform processes already underway in some countries. This happened because the United States concept was adopted but its content was not incorporated.<sup>1</sup>

It is worth noting then, that if in the United States the initiative responded to change in the nature of war, in our region undertaking as radical a process as transformation ended up as unnecessary.

Adopting a notion like military transformation necessarily demands adopting as well a new theory. When faced with the need to define a new theory it should be clear that the original factors in the analysis will be the so-called *military control elements*: objective, scenario, military forces, time and the principles of war.

Owing to the existing confusion and the interest in reforming the region’s armed forces, a number of years ago I proposed two triangles to analyze the reformation process, modernization, military change or whatever name we would like to give it. These triangles make available a methodology for the study of all three basic elements of the armed forces in their relation to society and all three elements intrinsic or endogenous to the force. The triangle analyzed in this work is the one I mentioned first. On the upper vertex is the *nature* of the armed forces, because they were born to perform a task that the social group entrusted them with since their inception. On the right vertex, the *legal standard*, then the Rule of Law gave them a legal framework. On the left vertex, the State delivers certain *capabilities* for them to perform their natural work according to the legal framework. These components or basic axes interact with each other and any change in one of them will impact on all others. Therefore, the options to reform, modernize or “transform” –if you like— are associated with the depth and scope of what needs to be changed.

It is important to understand and accept the reasons why the armed forces in the region have the characteristics they have. Constitutions, standing at the top

of the legal obligations pyramid, are, in those cases where the armed forces are referred to therein, their primary reference. Structuring armed forces in terms of threats does not seem to have any strategic sense. Threats are more volatile than Constitutions and may come and go; for this reason, threats may have an impact on operational or tactical changes in the short and medium term, but the strategic reason for armed forces design is a constitutional mandate, or, in certain cases a legal mandate, and must be commensurate with the country’s strategic challenge. When a country finds such a mission excessive, it has the political (certainly not the military) task of changing the role for those forces.

In this scenario, the study of reformulating the military apparatus must be undertaken based on serious, well-supported and technical diagnosis, and end up with the elaboration of a project with a realistic future consistent with the strategic horizon of the country, the region and ultimately, the world.

In the case of Latin America, an integration scenario is offered to work on, although in my opinion, underlying issues will delay progress until they are addressed. The first of them lies in diplomatic tensions over border issues that remain an obstacle to deep integration. And this is because they appear in a somewhat sensationalist communications environment that is more harmful than beneficial. This situation, in addition, encourages ultra-nationalist movements in each country to stir up discontent.<sup>2</sup>

The second issue is the ideological division in the region. Ideological instability persists in the region and this makes it difficult to predict whether different-sign government changes will occur without disruptions. The third issue is the dispute for regional leadership, in which Brazil is a natural protagonist.

Finally, and by way of conclusion, every country has to follow its own path. Perhaps, given the circumstances in the region, fortunately at this time not involving armed conflicts between countries, using the notion of “transformation” could be premature since there are no lessons learnt that may recommend something similar. In my judgement, what is most applicable to the majority of these countries is the design of forces based on capabilities, since this allows reconciling strategic uncertainty with the budgetary realities of the region.

1 Jaime García Covarrubias, “New Threats and Defence Transformation: The case of Latin America,” *Low Intensity Conflict & Law Enforcement*, Vol 12, Num 3, (Autumn 2004).

2 What I am pointing out could be seen between Chile and Peru since they are going through an arbitration procedure at The Hague. Every now and then there is an incident which, small as it may be, ends up with the recalling of ambassadors.

Chapter 8:

# Defence and National and International Community



### Military Troops from Latin American Countries involved in Peace Operations

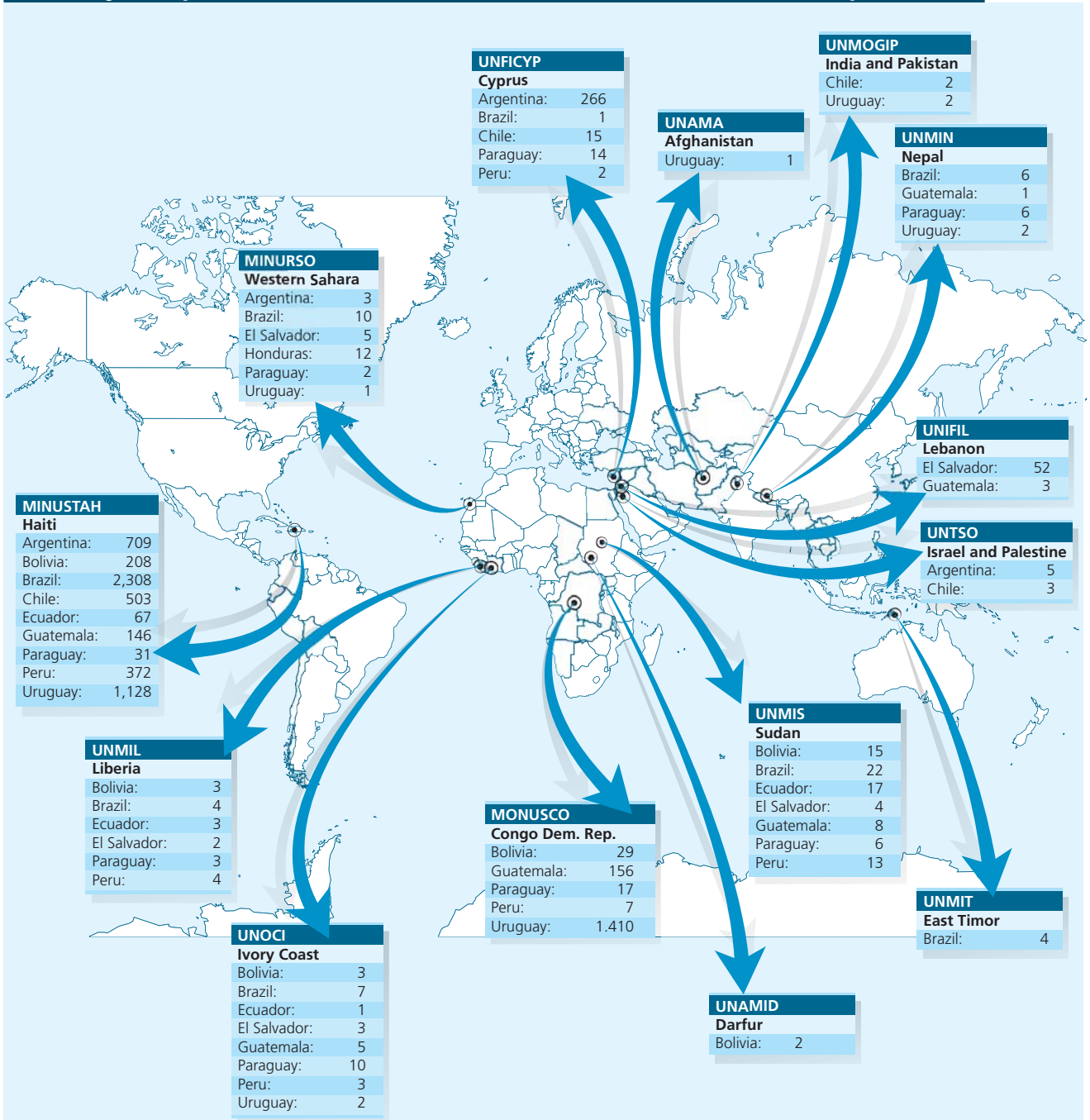

Compared Evolution of Latin America involvement in Peace Operations (2001-2010, %)

	2001-2002	2002-2003	2003-2004	2004-2005	2005-2006	2006-2007	2007-2008	2008-2009	2009-2010	Total Evolution 2001-2010
Latin America	131.4%	43.6%	7.5%	127.1%	-0.6%	5%	0.9%	1%	-0.2%	763.7%
Rest of the World	29%	-6.2%	8.9%	34.8%	9%	15.5%	2.3%	10.3%	7.1%	169.9%

The percentage represents the growth compared the previous year. Initial data: December 31, 2000 (742 Latin American soldiers). Closing, December 31, 2009 (6,401 Latin American troops).

Source: Compilation based on information provided by the website of the UN Department of Peacekeeping Operations.

### PKO Training Centres and Courses

Argentina	Ecuador
CAECOPAZ - <i>Centro Argentino de Entrenamiento Conjunto para Operaciones de Paz</i> (Armed Forces) - 27 June 1995	UEMPE - <i>Unidad Escuela Misiones de Paz Ecuador</i> (Armed Forces)- 10 November 2003
<ul style="list-style-type: none"> <li>- UN operating techniques</li> <li>- UN military observer</li> <li>- Negotiations in peace operations</li> <li>- UN logistics</li> <li>- International law of armed conflict</li> <li>- Human rights for peacekeepers</li> <li>- Disarmament, demobilization and reinsertion of former combatants</li> <li>- Civil-military coordination in peace operations</li> <li>- Humanitarian aid in peace operations scenarios</li> <li>- Train the trainer</li> <li>- "Train the Trainer" (given by the DPKO)</li> <li>- Senior staff of task force in Cyprus</li> <li>- Task force in Cyprus</li> <li>- UNFLIGHT for the air unit</li> <li>- Senior staff of the Argentine joint battalion in Haiti</li> <li>- Argentine joint battalion in Haiti</li> </ul>	<ul style="list-style-type: none"> <li>- Peacekeeper</li> <li>- MINUSTAH</li> <li>- Military observer</li> <li>- Staff</li> <li>- Police procedures in border and community actions</li> <li>- Press correspondents in peace operations</li> </ul>
Bolivia	El Salvador
COMPEBOL - <i>Centro de Operaciones de Mantenimiento de la Paz del Ejército de Bolivia</i> (Armed Forces) - 23 January 2007	EOPFA - <i>Escuela de Operaciones de Paz</i> (Armed Forces) - 1 July 2004
<ul style="list-style-type: none"> <li>- Training of the Bolivia Mechanized Infantry Company (<i>Compañía de infantería mecanizada Bolivia, CIMB</i>) "Haiti"</li> <li>- Training of the CIMB "Congo"</li> <li>- Peacekeeping operations for military observers</li> <li>- War correspondents</li> </ul>	<ul style="list-style-type: none"> <li>- UN military observer</li> <li>- UN logistics and finance</li> <li>- Peace operation military instructor</li> <li>- FINUL pre-deployment training</li> <li>- Staff Officer in peace operations</li> </ul>
Brazil	El Salvador, Honduras, Guatemala and Nicaragua
CCOPAB - <i>Centro Conjunto de Operaciones de Paz de Brasil</i> (Armed Forces)* - 15 June 2010	CREOMPAZ - <i>Centro Regional de Entrenamiento de Operaciones de Mantenimiento de la Paz</i> (Armed Forces) - 8 June 2005
<ul style="list-style-type: none"> <li>- Advanced exercise for peace operations</li> <li>- Introductory course for peace missions</li> <li>- Civil-military cooperation symposium</li> <li>- Introductory course for platoon and sub-unit Commanders</li> <li>- Introductory course for Staff officers</li> </ul>	<ul style="list-style-type: none"> <li>- UN terminology</li> <li>- UN staff</li> <li>- Military observers (national)</li> <li>- Military observers (international)</li> <li>- Contingent commander</li> <li>- MINUSTAH basic training</li> <li>- MONUC basic training</li> <li>- UN Instructor</li> <li>- Logistics and finance</li> <li>- Basic training of UN CFAC Battalion troops</li> </ul>
Chile	Paraguay
CECOPAC - <i>Centro Conjunto para Operaciones de Paz de Chile</i> (Armed Forces and Law-enforcement forces) - 15 July 2002	CECOPAZ - <i>Centro de Entrenamiento Conjunto de Operaciones de Paz</i> (Armed Forces) - 8 October 2001
<ul style="list-style-type: none"> <li>- Military observers</li> <li>- Peace operations</li> <li>- Police monitors</li> <li>- Correspondents in peacekeeping missions</li> <li>- International humanitarian law in armed conflicts for peace operations</li> <li>- At the service of peace (together with Leaster Pearson Centre of Canada)</li> <li>- Pre-deployment for national contingents</li> </ul>	<ul style="list-style-type: none"> <li>- Military decision making process in MINURCAT</li> <li>- UN contingent basic training</li> <li>- MINUSTAH pre-deployment advanced training: Infantry Company</li> <li>- MINUSTAH pre-deployment advanced training: Multi-role Engineering Company</li> <li>- UNFICYP Pre-deployment advanced training</li> <li>- UN military observer</li> <li>- Multi-national logistics</li> </ul>
Dominican Republic	Peru
<i>Escuela de Operaciones de Mantenimiento de la Paz</i> - June 29, 2010 (Recently created)	CECOPAZ - <i>Centro de Entrenamiento Conjunto de Operaciones de Paz</i> (Armed Forces) - 11 November 2003
	<ul style="list-style-type: none"> <li>- Military observers</li> <li>- Haiti pre-deployment</li> <li>- Peace correspondents</li> </ul>
Uruguay	
ENOPU - <i>Escuela Nacional de Operaciones de Paz de Uruguay</i> (Armed Forces)** - 28 August 2008	
<ul style="list-style-type: none"> <li>- UN military observer</li> <li>- UN multi-national Staff</li> <li>- UN police officers</li> <li>- National contingent in UN missions</li> <li>- National contingent in Sinai</li> </ul>	
CICAME - <i>Centro de Instrucción y Capacitación de Operaciones para el Mantenimiento de la Paz de la Policía</i> (Police)*** - 1 January 1996	
- UN police observers	

\* By means of *Guidance (Portaria)* N° 952-MD 2010/06/15, the previously called Peace Operation Training Centre was replaced - CI OP PAZ.

\*\*The ENOPU preceding organizations include the Peace Operation Training Centre of the Army (CIOPE), which began its operations in 1982, when Uruguay first made the commitment to send Engineers and Transportation Special Group to the Sinai Peninsula. Some years later, in 1998, this was replaced by the Peace Operation School of the Army (*Escuela de Operaciones de Paz del Ejército, EOPE*).

\*\*\* The precise date of the Centre's creation was 1996/03/01 and it operated until the end of February 1999. Afterwards, it began operating on March 1, 2004, when Police Observers were sent, again, both to Haiti and Ivory Coast missions.

### Troop Contribution to Peacekeeping by Region

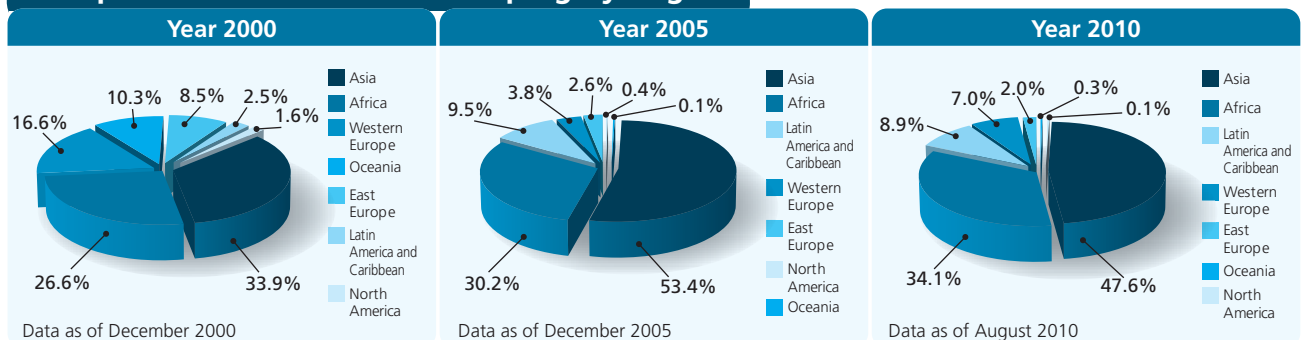

Source: Website of the UN Department of Peacekeeping Operations (DPKO-UN), and information provided by the training centres and Armed Forces of each country.





## Cooperation in the Event of Disasters

Country	Civil Defence Agency	Legal Grounds	Immediate Superior Authority*	Institutional Reporting
<b>Argentina</b>	National Direction of Civil Protection	There is no civil defence law, only executive, provincial and municipal rules. <i>Decreto</i> N° 1045/2001, establishing objectives and functions of the national leadership.	Minister of the Interior	Ministry of the Interior**
<b>Bolivia</b>	Deputy Minister of Civil Defence	<i>Ley No 1.405 orgánica de las Fuerzas Armadas de la Nación (1992/30/12)</i> <i>Ley N° 2.446 de organización del Poder Ejecutivo</i> , Regulated by <i>Decreto Supremo N° 27.230 (2003)</i> , ratified by D.S. N° 28.631, <i>Reglamento de la Ley N° 3.351</i> , and recognized by <i>Norma de organización del órgano ejecutivo D.S. N° 29.894</i> .	Vice Minister of Civil Defence and Cooperation for Integral Development	Ministry of Defence
<b>Brazil</b>	National Civil Defence Secretariat	<i>Decreto</i> No 5.376, governing the National System of Civil Defence and the National Council of Civil Defence, as well as other provisions (2005/17/01).	National Secretary	State Ministry of National Integration
<b>Chile</b>	National Emergency Office	<i>Decreto Ley N° 369</i> , which creates the National Emergency Office (1974/16/03)	Director	Ministry of the Interior
<b>Colombia</b>	Disaster Prevention and Response Office	<i>Decreto</i> N° 919, whereby, the National Disaster Prevention and Response System is organized (1989).	Chief of the National Office for Disaster Prevention and Response	Office of the President of the Republic
<b>Cuba</b>	National Civil Defence Staff of the Revolutionary Armed Forces	<i>Ley N° 75 de la defensa nacional (1994/21/12)</i> and <i>Decreto-Ley No 170 del sistema de medidas de defensa civil (1997/08/05)</i>	National Chief of Civil Defence Staff	Office of the President of the State Council through the Revolutionary Armed Forces
<b>Dominican Republic</b>	Civil Defence Office	<i>Ley</i> No 257-66, whereby a civil defence office is created (1966/07/06).	Executive Director	Office of the President of the Republic
<b>Ecuador</b>	National Directorate of Civil Defence	<i>Ley N° 275, de seguridad nacional (1979/09/08)</i> in Title III "de la Defensa Civil".	Director (General or Colonel or equivalent Navy staff officer)	Secretary General of the National Security Council
<b>El Salvador</b>	National Civil Protection, Disaster Prevention and Mitigation system	<i>Decreto</i> No 777, <i>Ley de protección civil, prevención y mitigación de desastres (2005/08/18)</i> y el <i>Decreto</i> No 56 (2006/24/05) <i>Reglamento de organización y funcionamiento de la dirección general de protección civil, prevención y mitigación de desastres</i> .	General Director	Ministry of Government
<b>Guatemala</b>	National Coordinator for the Reduction of Natural or Man-made Disasters	<i>Decreto Legislativo N° 109-96, Ley de la coordinadora nacional para la reducción de desastres de origen natural o provocado (1996/06/11)</i> ; <i>Acuerdo Gubernativo 443-2000</i> , Regulation of <i>Decreto Legislativo N° 109-106 (2000/09/12)</i> .	Minister of National Defence (military)	Ministry of Defence
<b>Honduras</b>	Permanent Commission of Contingencies	<i>Decreto</i> No 9-90-E, <i>Ley de contingencias nacionales (1991/26/07)</i> y <i>Acuerdo</i> No 661.91, (1990/12/12)	National Commissioner	Office of the President of the Republic
<b>Mexico</b>	National Civil Protection System	<i>Ley general de protección civil</i> (DOF 2000/05/12. Last Amendment: DOF 2006/04/24).	Secretary of Government	Office of the Secretary of Government
<b>Nicaragua</b>	National System for Disaster Prevention, Mitigation and Response  Nicaraguan Army's Civil Defence Staff	<i>Ley N° 337, de creación del sistema nacional para la prevención, mitigación y atención de desastres (2000/04/07)</i> and its Regulation (2000/06/28), <i>Decreto</i> No 53-2000.  <i>Ley N° 181, Código de organización, jurisdicción y previsión social militar (1994/09/02)</i> , y <i>Ley N° 337</i> and its Regulation.	Executive Secretary  Chief of Civil Defence Staff (EMDC) (Brigadier General)	President of the Republic  Nicaraguan Army
<b>Paraguay</b>	National Emergency Committee	<i>Ley N° 2.615/ 05 que crea la secretaria de emergencia nacional (2005/06/02)</i> .	Executive Director	Ministry of the Interior
<b>Peru</b>	National Civil Defence System	<i>Decreto Ley N° 19.338, Ley del sistema de defensa civil (1972/03/28)</i> , as amended and extended, and its Regulation ( <i>Decreto Supremo 005-88</i> ).	Director (military officer of a General or Admiral rank)	National Defence Council
<b>Uruguay</b>	National Emergency Directorate	<i>Ley</i> No 18.621, <i>sistema nacional de emergencias</i> , (National Emergency System) created as a permanent public system (200/10/25).	National Director	Office of the President of the Republic
<b>Venezuela</b>	National Civil Protection and Disaster Management Organization	<i>Decreto Presidencial</i> No 1.557, <i>Ley de la organización nacional de protección civil y administración de desastres (2001/11/13)</i> .	National Director of Civil Protection and Disaster Management	Ministry of the Interior and Justice

\* Only in the cases explicitly expressed in the corresponding Law; this chart indicates if the Higher Authority is a civilian or a military member.

\*\* Until July 1996, it reported to the Ministry of Defence. Decree 660-96 reassigns the National Direction of Civil Protection (DNPC) to the Ministry of the Interior (1996).

**Armed Forces Missions – Operational and Reporting Relationships**

<p>The National Civil Protection Directorate is in charge of the elaboration of civil protection doctrine, policy and planning and the coordination of support of law-enforcement and security forces, the Argentine Federal Police and the Armed Forces, with the purpose of mitigating the effects of disasters at a national level. Likewise, the decentralized characteristic of civil defence in Argentina allows provincial and municipal governments to coordinate the necessary means to respond in the event of an imminent situation.</p>
<p>The civil defence planning, conduct and supervision in the territory is under the responsibility of the Deputy Minister for Civil Defence, and the Commander-in-Chief coordinates with the former the participation of the Armed Forces in civil defence planning and execution.</p>
<p>The Ministry of Defence is part of the National Civil Defence Council and coordinates Special Forces' combined operations for civil defence actions.</p>
<p>There exist regional, provincial and community Emergency Committees presided over by the Regional Mayor, the Province Governor or the respective local Mayor, as applicable. In each one of these instances, each branch of the Armed Forces is represented, but there is no reference as to whether they would perform operative roles for the compliance of specific civil defence missions, nor is the type of relation they hold with civilian authorities specified.</p>
<p>The Ministry of National Defence is part of the National Disaster Prevention and Response System and of the National Committee for Disaster Prevention and Assistance, although it may delegate its responsibilities to the General Commander of the Military Forces. The latter are in charge of the disaster area isolation and security, air control, identification and control of ports and heliports in an emergency situation. A delegate from the Ministry of Defence is member of the National Technical Committee.</p>
<p>The Civil Defence System encompasses all levels of military hierarchy ranks: Ministry of the Revolutionary Armed Forces, National Civil Defence Staff, armies and Provincial and Municipal Staffs. The presidents of the Provincial and Municipal Assemblies of People's Power are the heads of civil defence in the pertinent territory and their work is supported by the civil defence bodies of provincial and municipal Staffs.</p>
<p>The Ministry of the Armed Forces has permanent representation at the Emergency Operations Centre, an integral part of the National System for Disaster Prevention, Mitigation and Response, which is conducted by the Civil Defence sector. In turn, it is part of the National Council for Disaster Prevention, Mitigation and Response, chaired by the President of the Republic (or his delegate), as well as of the National Technical Committee on Risk Prevention and Mitigation. The Armed Forces also have a representation at the regional, provincial and municipal committees for disaster prevention, mitigation and response. The Organic Law establishes that whenever the President of the Republic so resolves, they will provide cooperation in public emergencies or disasters.</p>
<p>The National Directorate reports to the General Secretariat of the National Security Council and its National Director is an officer of the Armed Forces (Joint Staff General or Colonel or equivalent Navy rank). The Provincial Boards are presided over by the respective governors and their vice president is the highest-ranking officer of one of the services. In times of peace, the Armed Forces support civil defence. The National Civil Defence System, in coordination with the National Directorate for Armed Forces Mobilization and private and public bodies, plan the activities provided for during the period prior to the adverse event. The Armed Forces, as a National System support organization, take part in the prevention, mitigation and reconstruction, and train the various military units for their involvement in those missions.</p>
<p>In a disaster, upon the requirement of the President of the Republic, of the National Commission or the General Directorate, the Armed Force shall provide quick and timely assistance to evacuate and aid the people, as well as to help them safeguard their life and property. The police may be helped by the Armed Force to secure public order, upon approval of the President of the Republic.</p>
<p>The Minister of Defence is the Coordinator of the National Council, the highest body of the National Coordinator, which he legally represents. Neither the Law nor its Regulation makes any reference to the Army in disaster situations.</p>
<p>The Secretary of Defence is part of the Permanent Commission. The Permanent Commission of Contingencies Creation Law establishes that the Armed Forces contribute personnel and means to assist in natural disasters and emergency situations affecting people and their property. However, neither this nor the National Contingency Law gives details of the conduct levels or operating relations with the National Commission.</p>
<p>The Secretaries of National Defence and the Navy are part of the National Civil Projection Council, a consulting body on civil protection planning matters. The Armed Forces participate in the response to extraordinary situations requiring immediate civil protection actions at any level of the institutional structure (federal, state or municipal). They coordinate with these instances' authorities and conduct the actions under their charge even though a disaster state may have not been declared. The General Civil Protection Law makes no reference to the type of relation established between the civil agency and the Armed Forces, or to any supervision procedures to control the armed forces in the performance of these missions.</p>
<p>The Army Commander-in-Chief accompanies the Minister of Defence in the integration of the National Committee for Disaster Prevention, Mitigation and Response. The Special Operations Commission (one of eight sector-led work commissions in the system) is presided over by a permanent delegate of the Army. The Civil Defence Staff guarantees the effective participation of the various Army units and their coordination with State institutions and the population in protection plans for natural disasters, catastrophes and similar events.</p>
<p>The Nicaraguan Army's Civil Defence Staff established the Disaster Operation Centre included within the National System. The System's Executive Secretariat, in coordination with the Civil Defence Staff declares the pertinent alert levels.</p>
<p>A general officer representing the Armed Forces is part of the National Emergency Committee presided over by the Ministry of Internal Affairs. The Armed Forces provide the National Emergency Committee any required cooperation.</p>
<p>The National Civil Defence Committee, one of the five levels the System is comprised of, is chaired by the Minister of Internal Affairs. The Armed Force Joint Staff is one of its members. The Committee has jurisdiction over the whole territory of the Republic and the Regional Committees within the geographic space covered by each Military Region. Each Regional Committee is presided over by the Commander of the pertinent military region. The National Institute for Civil Defence, a public body decentralized from the defence sector, governs and conducts the National Civil Defence System and its Chief is a General or Admiral, appointed by the President of the Republic upon proposal by the Minister of Defence.</p>
<p>The Minister of Defence is a member of the National Emergency System and Committee (chaired by the President of the Republic) and the National Emergency Council (chaired by the Secretary of the Presidency). Other participants are the Commanders-in-Chief of the Army, the National Navy and the Air Force, and the Director of the Permanent Technical Operating Directorate.</p>
<p>The National Civil Protection and Disaster Management Coordination Committee is part of the National Risk Management System and the National Citizen security Coordination; it is presided over by the Minister of Internal Affairs and Justice and a high-level representative of the Ministry of Defence has a seat in it. The law makes no reference to the Armed Forces.</p>

Source: Compilation based on the above-mentioned laws.



### Major Earthquakes and Hurricanes in Latin America and the Caribbean (1960-2010)

Event	Date	Intensity/Category*	Estimated Damage
Earthquake	<b>Chile</b> February 27, 2010	<b>8.8</b>	800 killed and missing; 2 million people affected; 1,5 million houses damaged; U\$S 30 billion in material damages.
Earthquake	<b>Haiti</b> January 12, 2010	<b>7.2</b>	More than 200 thousand killed; 250.000 injured; and one million homeless people.
Earthquake	<b>Costa Rica</b> January 8, 2009	<b>6.2</b>	34 killed.
Hurricane Félix	<b>Central America, Caribbean and Yucatan Peninsula</b> August 2008	<b>5</b>	133 killed, 130 of them in Nicaragua; 40.000 homeless; and U\$S 720 million in material damages.
Earthquake	<b>Peru (Chincha Alta)</b> August 15, 2007	<b>7.9</b>	519 killed; and 300.000 homeless.
Hurricane Wilma	<b>Yucatan, Cuba</b> October 2005	<b>5</b>	23 killed; and U\$S 29 billion in material damages.
Hurricane Stan	<b>Central America, South of Mexico and Haiti</b> October 2005	<b>1</b>	Heavy rains, floods and landslides; 1,600 killed; missing people in Guatemala and El Salvador.
Hurricane Katrina	<b>Bahamas, Florida, Louisiana, Mississippi</b> August 2005	<b>5</b>	Near 2,000 killed; and U\$S 75 billion in material damages.
Hurricane Iván	<b>Caribbean, Venezuela and United States of America</b> September 2004	<b>4</b>	64 killed; U\$S 13 billion in material damages in the United States and U\$S 3 billion in the Caribbean.
Earthquake	<b>El Salvador</b> January 13, 2001	<b>7.6</b>	200 houses buried due to landslides.
Hurricane Mitch	<b>Central America</b> October 1998	<b>5</b>	9,000 killed; 12,000 missing people; floods; 80% of crops destroyed; and U\$S 5 billion in material losses.
Hurricane Paulina	<b>South of Mexico</b> October 1997	<b>4</b>	400 killed; 300,000 homeless people; and U\$S 9 billion in material damages.
Hurricane Gilberto	<b>Caribbean and Gulf of Mexico</b> September 1988	<b>5</b>	318 killed; and U\$S 5 billion in material damages.
Earthquake	<b>Mexico</b> September 19, 1985	<b>8.1</b>	9,500 killed.
Earthquake	<b>Guatemala</b> February 4, 1976	<b>7.6</b>	Approximately 25,000 killed.
Hurricane Fifi	<b>Central America</b> September 1974	<b>3</b>	10,000 killed; and 600 thousand Honduran homeless.
Earthquake	<b>Nicaragua</b> December 24, 1972	<b>6.5</b>	10,000 killed.
Earthquake	<b>Peruvian Andes</b> May 31, 1970	<b>7.9</b>	66,000 killed
Hurricane Flora	<b>Caribbean</b> October 1963	<b>3</b>	Heavy rains: floods; more than 7,000 killed; and U\$S 528.6 million in material damages.
Valdivia Earthquake	<b>Chile</b> May 22, 1960	<b>9.5**</b>	2,000 killed; tsunami which devastated coastal areas and caused deaths in Hawaii, Japan and Philippines.

\*Earthquake intensity is measured according to the Richter scale. Hurricane category is determined according to Saffir- Simpson scale.

\*\*The most powerful earthquake ever recorded

**Source:** Compilation based on the information supplied by different related agencies.

**Regular Internal Order Programs**

Country	Program or Facultative Rule	Activities of the Armed Forces
<b>Bolivia</b>	Supreme Decree N° 27.977	- Demonstration and riot control
	Security City Plan	- Patrolling
	Joint Task Force	- Eradication of surplus coca crops.
<b>Brazil</b>	Supplementary Law N° 97	- Patrolling. - Inspection of people, road vehicles, ships and airplanes. - Arrest of people caught in flagrant crime.
<b>Colombia</b>	Consolidation Policy of Democratic Security / Illegal Armed Groups	- Offensive military incursions and containment of illegal armed groups - Law-enforcement and civil-military inter-agency coordination.
	Policy of Democratic Security Consolidation /Drug Trafficking	- Illegal crop eradication. - Interdiction operations by land, sea, rivers and air. - Neutralization of illegal armed groups involved in any business stage, and of drug trafficking and armed organizations. - Control of the territory.
	Policy of Democratic Security Consolidation/ Public Security	- Intelligence - Strengthening law-enforcement presence, increase in number of strength.
<b>Dominican Republic</b>	Presidential Decree N° 310-06 Joint Doctrine Handbook of the Armed Forces	- Support to the National Police in the prevention of crime and to guarantee citizen peace. - Jointly with the National Police: regular patrols and surveillance checkpoints, involvement in operations, criminal activity interdiction, stabilization activities. - Anti-drug support activities using military means.
<b>El Salvador</b>	Joint Community Support Groups	- Patrolling, seizure or arms and drugs, arrests, inspection of people and vehicles.
	"Nuevo Amanecer" (New Sunrise) Campaign	- Patrolling, arms and drugs seizure; arrests and people and vehicle inspections; joint operations and police coordination; security at schools and detention centres, reception of crime reports.
	Support plan for detention centres management Cuscatlán Plan	- Patrolling, arms and drugs seizure; arrests; people and vehicle inspections. - Support in the fight against drug trafficking from the branches of the Armed Forces.
<b>Guatemala</b>	Master Law of the national security system	- Military Police Brigade. Patrolling to support the National Police in citizen security and fighting against drug trafficking.
<b>Honduras</b>	Bases of the National Defence Policy	- Joint operations with the National Police for anti-gang control, patrolling, surveillance, inspection, arrests. - Support to organized crime control. - Support to drug trafficking control.
<b>Mexico</b>	Guidance for integral fight against drug trafficking 2007-2012 "Inflexible Operation"	- Fight against organized crime and drug trafficking: surveillance, offensive actions, inter-agency coordination, inspection, seizure.
<b>Nicaragua</b>	Permanent Security Plan in the Countryside	- To counteract illegal activities of regular and organized crime. - Particular and combined operating services with the National Police: patrolling to combat the trafficking of drugs, arms and ammunitions, smuggling and trafficking of fauna and flora, illegal fishing and hunting.
	Integral Plan of the Army – National Police	- To fight crime in the countryside, jointly with the National Police.
	Integral Plan to Fight Drug Trafficking and Organized Crime	- Operations carried out by the Naval Force of the Nicaraguan Army to fight drug trafficking and organized crime.
<b>Venezuela</b>	Organic Law of the National Bolivarian Armed Forces N° 6.239	- Bolivarian National Guard. to cooperate in the investigation and prevention of crimes relating to drugs and psychotropic substances, kidnapping and extortion, border and rural security road security, surveillance of strategic industries, ports and airports, immigration control, public order, public security, criminal investigation; support, custody and surveillance of facilities and the property of the Legislative and Judicial Branches, the Citizen Power and Voting Power and support to Civil Protection and Disaster Management agencies.
	ZeroContraband Plan	- Bolivarian National Guard. Seizure, detention and inspection for smuggling activities.
	"Secure Caracas" (Caracas Segura) Plan	- Bolivarian National Guard. Protection, patrolling and intelligence in each parish of Caracas.
	Anti-drug Officers of the Armed Forces Guard	-Seizure, operations, inspection.
<b>Argentina Chile Ecuador Paraguay</b>	The Armed Forces' involvement in law and order functions is admitted only under a state of exception. In Chile, the state of exception was declared after the 2010 earthquake to maintain public order.  In Ecuador, the state of exception was declared at the end of September 2010, in order to re-establish public order after a Police mutiny.  At the beginning of 2010, in Paraguay this status was required in 5 departments for a 30-day period with the purpose of dismantling a guerrilla group. In such period, a joint police-military operation was carried out.	
<b>Cuba</b>	The President of the State Council is entitled to use the Revolutionary Armed Forces to keep internal peace, even if the state of emergency has not been declared.	
<b>Peru</b>	The recent approval of Decree Law N° 1.095 provides for the Armed Forces involvement in different areas relating to internal peacekeeping, whenever police capacity is overwhelmed upon the instruction of competent authorities.	
<b>Uruguay</b>	Even though the Armed Forces do not develop regular law-enforcement activities, the National Defence Act establishes that, under expressed authorization given by the Minister of National Defence, the Armed Forces shall be entitled to render services in different activities, when called upon. To date, the President has announced that between 1.500 and 2.000 soldiers will be transferred to activities of the police force.	

Source: Laws in force and official security, defence and development plans of the countries under consideration. Websites of the Ministries of Defence and Armed Forces.



## Protection of Natural Resources

All Latin American countries introduce in their defence policies the recognition and protection of national resources, as well as their environmental riches. The following map indicates some examples of actual activities presently carried out by the Armed Forces for the defence and protection of both natural resources and the environment as a whole.

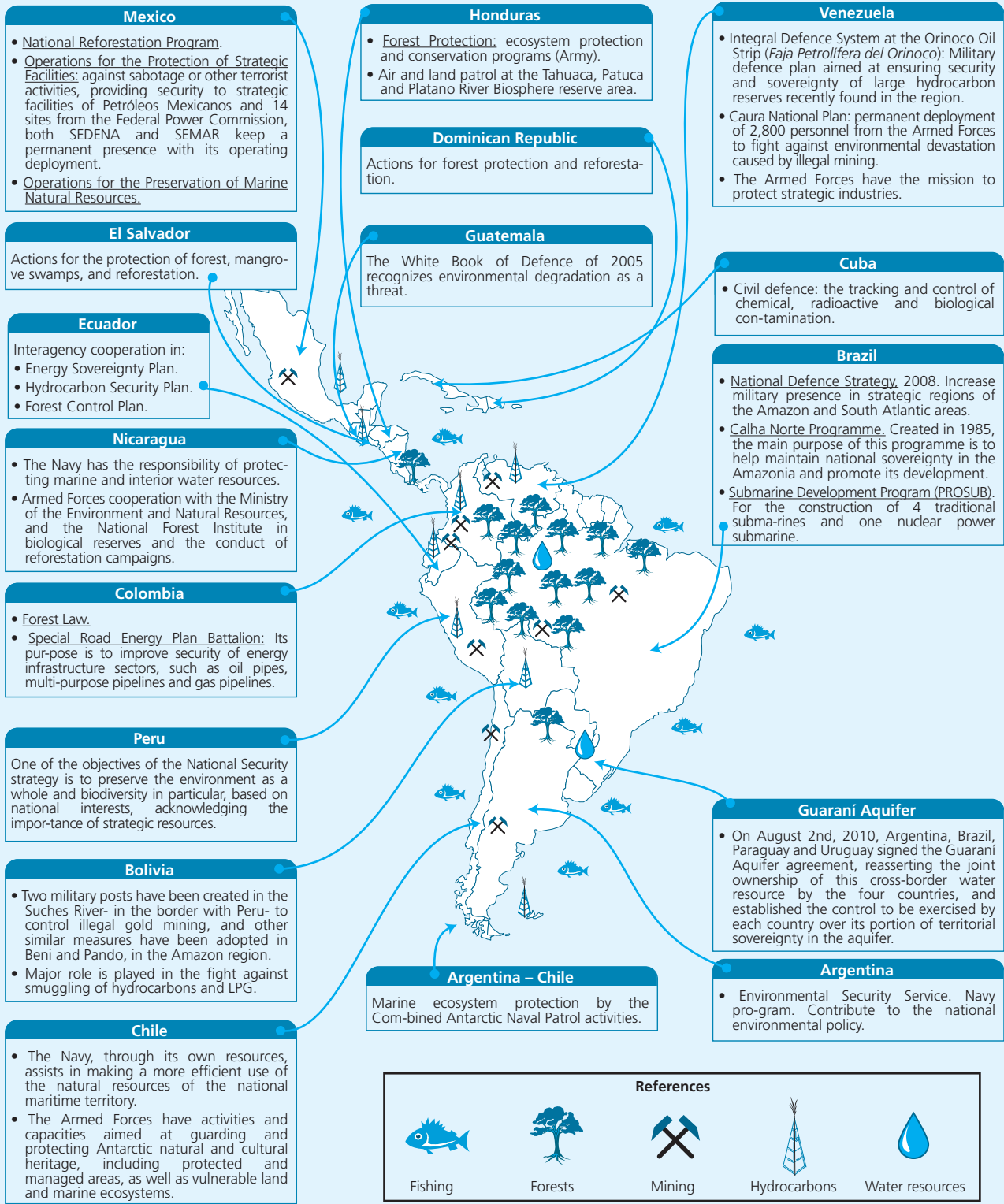

**References**



Fishing



Forests



Mining



Hydrocarbons



Water resources

**Source:** Defence White Books, institutional reports, websites of the Armed Forces, energy ministries and natural resource ministries from the various countries. Data provided by the pertinent countries. British Petroleum's "Statistical Review of World Energy 2009" Report. UNESCO's "Water in a Changing World" Report. Website of the UN Food and Agriculture Organization (FAO).

## Community Support Areas

The Armed Forces of Latin America are aimed to progressively adopt more roles in terms of community outreach and support programs. All countries in the region undertake actions and campaigns that reflect the greater participation of the Armed Forces in society's development. The following are some examples of each case:

Campaign Type	
<p><b>Food Distribution</b></p> <ul style="list-style-type: none"> <li>• <b>Argentina:</b> National Community Support Plan by the Army in Argentina for food distribution, among other objectives.</li> <li>• <b>Colombia:</b> delivery of food to communities in the Amazon.</li> <li>• <b>Mexico:</b> Aquarium Plan for water distribution.</li> </ul>	<p><b>Education</b></p> <ul style="list-style-type: none"> <li>• <b>Bolivia:</b> Juancito Pinto Bonus. Annual school grant. The Bolivarian Armed Forces participate in its allocation.</li> <li>• <b>Chile:</b> awareness action regarding military reality.</li> <li>• <b>Dominican Republic:</b> Program to promote patriotic values.</li> <li>• <b>Nicaragua:</b> coordination with the Ministry of Education, particularly in remote areas.</li> <li>• <b>Peru:</b> literacy campaigns.</li> <li>• <b>Uruguay:</b> literacy and primary education program for adults.</li> </ul>
<p><b>Infrastructure / housing</b></p> <ul style="list-style-type: none"> <li>• <b>Brazil:</b> Calha Norte Program in support of the community, divided in 194 municipalities.</li> <li>• <b>Cuba:</b> people protection with works of infrastructure.</li> <li>• <b>Ecuador:</b> Road Emergency Plan.</li> <li>• <b>Guatemala:</b> well drilling for 6,200 beneficiaries.</li> <li>• <b>Paraguay:</b> UNMISA Program, Stage 2 of construction.</li> </ul>	<p><b>Health</b></p> <ul style="list-style-type: none"> <li>• <b>Salvador:</b> media campaigns, with 16,539 beneficiaries in 2009.</li> <li>• <b>Honduras:</b> Civil-Military Action Program and Humanitarian Assistance: recovery works, medication delivery, among other things.</li> <li>• <b>Venezuela:</b> Air Ambulance Program to the Service of the People (since 1999).</li> </ul>

**Sources:** Legislation in force, White Books and official security, defence and development plans of countries under review. Websites of the Ministry of Defense and the Armed Forces.

## Antarctica



### Antarctic Treaty – Washington, December 1st, 1959

Member States: Argentina, Australia, Belgium, Brazil, Bulgaria, China, Chile, Ecuador, Finland, France, Germany, India, Italy, Japan, the Netherlands, New Zealand, Norway, Peru, Poland, Russia Federation, South Africa, South Korea, Spain, Sweden, Ukraine, the United Kingdom, United States, Uruguay.

Art. I – “1. Antarctica shall be used for peaceful purposes only. There shall be prohibited, inter alia, to conduct any measure of a military nature, such as the establishment of military bases and fortifications, the carrying out of military manoeuvres, as well as the testing of any type of weapon. 2. The present Treaty shall not prevent the use of military personnel or equipment for scientific research or for any other peaceful purpose.”

Art. IV – “2. No acts or activities taking place while the present Treaty is in force shall constitute a basis for asserting, supporting or denying a claim to territorial sovereignty in Antarctica or create any rights of sovereignty in Antarctica. No new claim, or enlargement of an existing claim, to territorial sovereignty in Antarctica shall be asserted while the present Treaty is in force.”

Countries with declared claims to territorial sovereignty in Antarctica: Argentina, Australia, Chile, France, Norway, New Zealand, and the United Kingdom.

In March 2009, 111 scientific bases existed in Antarctica, with a maximum of 4,460 personnel members in total.

Bases in Antarctica		
Country	Bases	Personnel
<b>America</b>		
Argentina	14	667
Brazil	1	40
Chile	21	359
Ecuador	2	26
Peru	1	28
United States	6	1,293
Uruguay	2	60
<b>Africa</b>		
South Africa	1	80
<b>Asia</b>		
China	3	90
India	2	65
Japan	5	125
South Korea	1	70
<b>Oceania</b>		
Australia	5	200
New Zealand	1	85
<b>Europa</b>		
Belgium	1	-
Bulgaria	1	18
Czech Republic	1	20
Finland	1	20
France	4	125
Germany	4	90
Italy	7	102
Norway	2	44
Poland	1	40
Russia	12	429
Spain	2	50
Sweden	1	20
Ukraine	1	24
United Kingdom	6	217
<b>Join Bases</b>		
France and Italy	1	60
Australia and Romania	1	13

**Note:** Maximum number of bases and personnel as of March 2009.

**Source:** Website of the Antarctic Treaty Secretariat, Scientific Committee on Antarctic Research and Council of Managers of National Antarctic Programs. *Antarctic Treaty, 1959, Book of National Defense of Chile, 2010.*



Analisis:

## National Defence and Disasters: A Preliminary Approach

**Roberto Cajina**

*Member of the RESDAL Board of Directors*

■ The tragedy in Haiti in January 2010 once again brought to the table of hemispheric and international debate the issue of disasters and international humanitarian assistance. One and a half month later, the disaster in Chile added the issue of the relation between national defence and disasters, a new line to be explored around political-military relations.

Latin American and Caribbean countries, the Gulf of Mexico and the US East Coast have always been under the threat of devastating disasters, whether natural -- earthquakes, hurricanes, depressions, tropical storms and other phenomena including floods, landslides and tornadoes-- or anthropogenic, like the oil spill in the Gulf of Mexico. Usually material losses and human fatalities, including dead and missing people, cannot be calculated and official data barely offer estimations and approximate figures. This makes it impossible to have a clear idea of the actual magnitude of these events and their economic, political, and social impacts and their dangerous effects on the democratic stability and governance of the countries affected.

Mexico, Guatemala, El Salvador, Honduras, Nicaragua, Costa Rica, Panama, Colombia, Ecuador, Peru, Bolivia and Chile, are located on the *Pacific Ring of*

*Fire* and, therefore, under the permanent threat of earthquakes of varying intensities and magnitudes. The origin of these seismic movements is twofold: volcanism and the collision of tectonic plates. In addition, the countries around the Caribbean Basin --Mexico, Central America, small insular Caribbean states, Venezuela and Colombia--are located on the road of hurricanes and tropical storms and depressions occurring between June 1 and November 31 every year. Also the Minor Antilles are shaken by seisms, not very frequent but at times, devastating, as the earthquake in Haiti. Hispaniola is crossed by two geological faults; the one that destroyed Port-au-Prince (the *Enriquillo – Plantain Garden*) had been dormant for almost two centuries, silently accumulating colossal amounts of energy. When it was released, the discharge was equivalent to the explosion of 200 thousand kilograms of TNT and caused a catastrophic tragedy.

### **Haiti and International Humanitarian Assistance**

The Haitian tragedy was magnified by a complex set of economic, social, political and cultural factors. At the time of the disaster the country was just escaping

from being a classic example of failed state thanks to the presence of the MINUSTAH, which neither had the mandate nor the capacity to immediately respond to and mitigate the effects of the seism, and much less so the Haitian authorities. The whole world was under commotion, but the United Nations was not prepared to confront a disaster of this magnitude.

With its main port destroyed and the airport control tower demolished, the operative priority was to take control of the only landing strip available; the number of aircraft bringing humanitarian assistance exceeded the capacity of land controllers and many of them had to be rerouted to the Dominican Republic. Criticism to the presence of United States military was fast to come although they took care of air traffic and proceeded to patrol Port-au-Prince, upon the request of President Rene Preval. Clearly, mistakes were made because chaos dominated the reception and distribution of help, which revealed the absence of a national higher authority to control and coordinate all operations and, at the same time, conduct military and police forces to put under rein the excesses of a desperate population of wounded, starved and homeless people. But it is also clear that there is a lack of protocols and coordination mechanisms for an ordered and efficient administration of international humanitarian assistance.

#### **Chile: Weaknesses of the Political Power**

Chile's case is paradoxical: in a country with enviable levels of political and economic stability and governance standards, there was ample and generalized criticism to the government's response to the disaster. Many wondered how many deaths, missing people and material damage could have been avoided if the government's response and search, salvage and rescue efforts had had the necessary speed and effectiveness and why public order could not be controlled from the beginning.

Chile has a long tradition of and conducts permanent and systematic drills for preparedness to face earthquakes and tsunamis; there were, however, grave mistakes in the central Government's immediate response to the crisis. The first one of them (the most dramatic on account of the number of victims, higher even to those resulting from the earthquake itself) was an inadequate handling of the seaquake alert. But even if that had been identified in time, it is unlikely that the information would have been transmitted to local coast authorities, as the alarm system operates on the telephone and the Internet, which were not running on account of power failure.

The second one, the slow reaction of the govern-

ment in the distribution of food, medicine and essential items to the southern cities which had been hit the most by the seism, partly because without power and without communications there was no manner of transmitting local needs and thus, respond accordingly. Finally, central authorities had to face the dilemma of mobilizing the armed forces to assist in attention and mitigation tasks and in preserving or reinstating public order. The government hesitated, delaying the decision, partly because of political calculations and a particular reluctance to use the armed forces, given the negative experience during the military regime.

These mistakes, though serious, must be seen in perspective, based on a universally accepted principle: it is impossible to reach perfection in a disaster situation of such magnitude and complexity, where critical decisions have to be made in a simultaneous and coordinated manner, at short notice, with a large number of officials separated by large distances and, even worse, without communications and maybe damaged themselves.

Without seeking to justify these mistakes on the argument that others have done worse, it is worth noting that more serious mistakes were made in the US for the prevention and response to Hurricane Katrina in New Orleans. Close to two thousand people were killed and dozens of thousand individuals stayed trapped for days in their flooded homes, stadiums and convention centres. Looting, violence and vandalism were rampant and did not cease but upon the belated arrival, almost one week later, of 40,000 troops of the National Guard to impose order and guarantee security.

#### **Civil Defence and Armed Forces**

All the countries in the region have in place a civil defence system for disaster prevention, response and mitigation. However, for their compliance with these tasks, they are almost absolutely dependent on the capabilities, human and material resources of their respective armed forces. These systems have many elements in common and their relations with their military are considered in their constitutional order and/or in the ordinary legislation of each country. But this is no easy interaction, which reveals a particular aspect of the relations between the political power and the armed forces, a very significant component of politico-military relations and hence, of the civilian conduct of the armed forces. Until now, the relation on disaster situations has not been addressed in depth by social or political sciences. It also involves the armed forces' non-military missions or subsidiary missions, the debate of which is still to be addressed in some countries





in the region.

One of the most interesting aspects is that the relation between civil defence and armed forces does not respond to a common pattern in the region. And that, overall, each country defines the model that best fits its risks, vulnerabilities and threats, and its available capabilities and resources, in order to attain higher efficiency and effectiveness in disaster prevention, response and mitigation. In the case of those relatively foreseeable (e.g. hurricanes) emergency committees are activated with due notice. But in the case of earthquakes, which are almost impossible to predict, they act only after disaster has occurred, launching a complex decision-making process, including the mobilization of the armed forces for a variety of missions not related to the classic notion of national defence, which gives rise to the so-called overlapping of functions.

### **Some Provisional Conclusions**

Reality shows that there is no single model in the interrelation between national defence and disaster assistance and that the most advisable course of action is for each country to adopt the one that best matches its needs and resources to efficiently face its identified risks, vulnerabilities and threats. The Special Declaration on Security in the Americas (Mexico 2003) included natural and anthropogenic disasters in the list of new threats, concerns, and other challenges of diverse nature in relation to the security of the States of the Hemisphere.

The relations between disaster response and armed forces are complex and difficult and are conditioned by legal and political issues. The former refers to what the constitution and the legal system of each country establish, especially as regards states of exception (emergency), armed forces roles and missions, higher command and conduct, entry and exit of national and foreign troops. If strictly applied, the last of these aspects represents a severe limitation to the speed and effectiveness of international humanitarian assistance.

The political factors refer to a complex decision-making process, especially in what moment the political authority orders the armed forces to intervene in the response to and mitigation of disaster, what is their role in public order preservation or restoration, what limits there are to the authority vested upon them and what supervision and control protocols are in place.

The analysis of armed forces' participation in disaster situations is included in the classical context of political-military relations and, within this framework, it has its own pros and cons.

It is unanimously recognized that such participation is fundamental owing to the attributes inherent to the forces: discipline, command and control capabilities, verticality of command, fast response and fast and ordered deployment capability; availability of means and techniques; sea, land and air mass transportation capacity, and self-sustaining capacity for relatively long periods on the field. All of the above, in contrast with civil agencies' marked proneness to bureaucracy in their operations.

On the other hand, the militarization of the affected areas (which is of lesser importance when human lives are at stake) is also subject to criticism along with a limitation to the political capabilities, referred to the decision-making process in the operating front, particularly affecting local and regional civil authorities and, to a lesser extent, the central government. And, finally, the media impact, i.e. the manner in which communication means overrate and criticize military involvement and authority. This is particularly relevant in societies with political hypersensitivity derived from former experiences. Chile is, in this case, an emblematic example that greatly differs from what happens in Central America, for instance, where after a disaster, the victims demand and receive with relief the presence of the men in uniform.

Disaster prevention, response and mitigation is a responsibility that must be fully shared by civil and military authorities and the population at large, and this calls for prior preparation and a process of ongoing education, both formal and informal, of territorial organization of the population and the performance of planned exercises and drills, all essential components of a prevention culture.

A correct coordination between agencies is as critical as international coordination. Haiti is an emblematic example of what must not be done in this respect or, to put it in positive terms, how the international community needs to act in disaster situations and the necessity to have a single national authority directing and coordinating the response and mitigation efforts. To this end, international cooperation protocols have to be agreed upon to standardize procedures, streamline them and make them more efficient, in such manner that their contribution may be effective to alleviate the dramatic effects of any disaster.

Much remains to be done. Beyond and above what the general rules of constitutional order and ordinary legislation prescribe, little has been attained in the pursuit to optimize international humanitarian assistance and find the best interrelation of civil defence and armed forces. Coherence is the key.

# The Caribbean

## Defence and Security in the Anglophone Caribbean The Roads to Cooperation























The Anglophone Caribbean and Latin America represent different realities joined through geography and found in the same hemisphere. They share many of the same hemispheric structures and also (though only partly) historical agendas and pattern of relations with their neighbours. Knowledge of the defence and security realities of the Caribbean adds to the sense of being part of the same hemisphere and affects the policies of many Latin American countries, as witnessed by the involvement of Guyana in the South American Defence Council, existing cooperation and accords, and their common participation in Defence Ministerial Conferences and the OAS Committee on Hemispheric Security.

This Dossier presents data and analyses on twelve countries of the Anglophone Caribbean: Antigua and Barbuda, Bahamas, Barbados, Belize, Dominica, Grenada, Guyana, Jamaica, Saint Kitts and Nevis, Saint Lucia, Saint Vincent and the Grenadines, and Trinidad and Tobago. The information contained allows one to appreciate the richness of their relations and experiences and the prospects of bringing the Latin American and Caribbean regions closer, thus associating two regions that evolve and cooperate in the same space.

Anglophone Caribbean countries' political systems derive from their British colonial past and, because of both history and language, the region has developed its strongest ties with such actors as Canada, the USA and Great Britain. In matters of security and defence, Anglophone Caribbean countries share an agenda with the one another and, in many instances, participate in regional structures, including the Regional Security System. The characteristics of their territories and populations have had an impact on the composition of either regular and sizeable defence forces or, as another political option, the presence of constabulary or police forces.

Fledgling relations of cooperation in security and defence have been strengthened by a landmark event: the 2007 Cricket World Cup. In addition, these countries share their space with other independent countries, including Cuba, Haiti and the Dominican Republic, and dependencies of other countries, such as the USA, France, the UK and The Netherlands, with a variety of legal status, with which they tend to have cooperation agreements. In sum, all twelve countries, sharing cultural ties and structures, have certain particular aspects and make their own distinctive political choices with respect to their defence systems and relations with other countries, including those in Latin America.

### Defence and Security Forces

Antigua and Barbuda		
Bahamas		
Barbados		
Belize		
Dominica		
Grenada		
Guyana		
Jamaica		
Saint Kitts and Nevis		
Saint Lucia		
Saint Vincent and the Grenadines		
Trinidad and Tobago		
		
	<b>Defence Forces</b>	<b>Defence/Police Forces</b>

### Defence Force's Mission

Country	Defence, sovereignty and Territory	Cooperation to internal Order and Security	Assistance in the event of emergency and/or natural disaster
Antigua and Barbuda	x	x	x
Bahamas	x	x	x
Barbados	x	x	x
Belize	x	x	x
Dominica	In the event of war or other emergency, if proclaimed by the authorities, the Police Force shall be a military force which may be employed for State defence		
Grenada	In the event of war or other emergency, if proclaimed by the authorities, the Police Force shall be a military force which may be employed for State defence		
Guyana	x	x	x
Jamaica	x	x	x
Saint Kitts and Nevis	x	x	x
Saint Lucia	In the event of war or other emergency, if proclaimed by the authorities, the Police Force shall be a military force which may be employed for State defence		
Saint Vincent and the Grenadines	In the event of war or other emergency, if proclaimed by the authorities, the Police Force shall be a military force which may be employed for State defence		
Trinidad and Tobago	x	x	x

**Sources:** Defence (Amendment) Act, 2007 (Antigua and Barbuda). Defence Act, Chapter 211 (Bahamas). Defence Act, Chapter 159 (Barbados). Defence Act, Chapter 135 (Belize). Police Act, Chapter 14:01 (Dominica). Defence Act, Chapter 15:01 (Guyana). Ministry of National Security and The Defence Act (Jamaica). Defence Act (Saint Kitts and Nevis). Defence Act, Chapter 14:01 (Trinidad and Tobago).



**Official name: Belize**



*Population:* 313.000 inhabitants.  
*Governor General:* Colville Young.  
*Prime Minister:* Dean Barrow.

Parliamentary monarchy since 1981. Member of the Commonwealth.  
 Belize Defence Force, 1978.  
 Belize Police Department, 1973.  
*Organizations:* ACCP, ACS, CARICOM, CDEMA, OEA.

**Official name: Commonwealth of The Bahamas**



*Population:* 346.000 inhabitants.  
*Governor General:* Arthur Foulkes.  
*Prime Minister:* Hubert Ingraham.

Parliamentary monarchy since 1973. Member of the Commonwealth.  
 Royal Bahamas Defence Force, 1980.  
 Royal Bahamas Police Force, 1840.  
*Organizations:* ACCP, ACS, CARICOM, CDEMA, IMPACS, OEA.

**Official name: Federation of Saint Kitts and Nevis**



*Population:* 52.000 inhabitants.  
*Governor General:* Cuthbert Sebastian.  
*Prime Minister:* Denzil Douglas.

Parliamentary monarchy since 1983. Member of the Commonwealth.  
 Royal Saint Kitts and Nevis Defence Force, 1896.  
 Royal Saint Kitts and Nevis Police Force, 1960.  
*Special service unit:* Special Service Unit.  
*Organizations:* ACCP, ACS, CARICOM, CDEMA, IMPACS, OEA, OECS, RSS



**Official name: Saint Vincent and the Grenadines**



*Population:* 109.000 inhabitants.  
*Governor General:* Frederick Ballantyne.  
*Prime Minister:* Ralph Gonsalves.

Parliamentary monarchy since 1979. Member of the Commonwealth.  
 Royal Saint Vincent and the Grenadines Police Force, 1979.  
*Special service unit:* Special Service Unit.  
*Organizations:* ACCP, ACS, CARICOM, CDEMA, IMPACS, OEA, OECS, RSS.

**Official name: Jamaica**



*Population:* 2.825.928 inhabitants.  
*Governor General:* Patrick Allen.  
*Prime Minister:* Bruce Golding.

Parliamentary monarchy since 1962. Member of the Commonwealth.  
 Jamaica Defence Force, 1962.  
 Jamaica Constabulary Force, 1832.  
*Organizations:* ACCP, ACS, CARICOM, CDEMA, IMPACS, OEA.

**Official name: The Republic of Trinidad and Tobago**



*Population:* 1.344.000 inhabitants.  
*President:* George Maxwell Richards.  
*Prime Minister:* Kamla Persad-Bissessar.

Parliamentary Republic (Independence 1962). Member of the Commonwealth.  
 Trinidad and Tobago Defence Force, 1962.  
 Trinidad and Tobago Police Force Service, 1792.  
*Organizations:* ACCP, ACS, CARICOM, CDEMA, IMPACS, OEA.

**Official name: Grenada**



*Population:* 104.000 inhabitants.  
*Governor General:* Carlyle Glean.  
*Prime Minister:* Tillman Thomas.

Parliamentary monarchy since 1974. Member of the Commonwealth.  
 Royal Grenada Police Force, 1853.  
*Special service unit:* Special Service Unit.  
*Organizations:* ACCP, ACS, CARICOM, CDEMA, IMPACS, OEA, OECS, RSS.

**Official name: The Republic of Guyana**



*Population:* 761.000 inhabitants.  
*President:* Bharrat Jagdeo.  
*Prime Minister:* Sam Hinds.

Semi-presidential republic (Independence 1966). Member of the Commonwealth.  
 Guyana Defence Force, 1965.  
 Guyana Police Force, 1839.  
*Organizations:* ACCP, ACS, CARICOM, CDEMA, IMPACS, OEA.

**Source:** compilation based on information supplied by the mentioned institutions. Population: *Anuario Estadístico de América Latina y el Caribe*, 2009, ECLAC.

**Official name: Antigua and Barbuda**



Population: 89.000 inhabitants.  
 Governor General: Louise Lake-Tack.  
 Prime Minister: Baldwin Spencer.  
 Parliamentary monarchy since 1981. Member of the Commonwealth.  
 Royal Antigua and Barbuda Defence Force, 1981.  
 Royal Antigua and Barbuda Police, 1967.  
 Special service unit: Special Patrol Group.  
 Organizations: ACCP, ACS, CARICOM, CDEMA, IMPACS, OEA, OECS, RSS.

**Official name: Commonwealth of Dominica**



Population: 67.000 inhabitants.  
 President: Nicholas Liverpool.  
 Prime Minister: Roosevelt Skerrit.  
 Parliamentary Republic (Independence 1978). Member of the Commonwealth.  
 Dominica Police Force, 1940.  
 Special service unit: Special Service Unit.  
 Organizations: ACCP, ACS, CARICOM, CDEMA, IMPACS, OEA, OECS, RSS.

**Official name: Saint Lucia**



Population: 174.000 inhabitants.  
 Governor General: Pearlette Louisy.  
 Prime Minister: Stephenson King.  
 Parliamentary monarchy since 1979. Member of the Commonwealth.  
 Royal Saint Lucia Police Force, 1834.  
 Special service unit: Special Service Unit.  
 Organizations: ACCP, ACS, CARICOM, CDEMA, IMPACS, OEA, OECS, RSS.

**Official name: Barbados**



Population: 257.000 inhabitants.  
 Governor General: Clifford Husbands.  
 Prime Minister: David Thompson.  
 Parliamentary monarchy since 1966. Member of the Commonwealth.  
 Barbados Defence Force, 1979.  
 Barbados Police Force, 1835.  
 Special service unit: Task Force.  
 Organizations: ACCP, ACS, CARICOM, CDEMA, IMPACS, OEA, RSS.

**National legislation**

<b>Antigua and Barbuda</b>	- Police (Amendment) Act, 1998. - Defence (Amendment) Act, 2007.
<b>Bahamas</b>	- Police Act, Chapter 205, 1965. - Defence Act, Chapter 211, 1979.
<b>Barbados</b>	- Defence Act, Chapter 159, 1985. - Police Act, Chapter 167, 1998.
<b>Belize</b>	- Police Act, Chapter 138, 1951. - Defence Act, Chapter 135, 1978.
<b>Dominica</b>	- Police Act, Chapter 14:01, 1940.
<b>Grenada</b>	- The Police Act, Chapter 244, Revised Laws of Grenada 1990.
<b>Guyana</b>	- Police Act, Chapter 16:01, 1957. - Defence Act, Chapter 15:01, 1966. - Status of Visiting Police Forces Act, 7, 2008.
<b>Jamaica</b>	- The Constabulary Force Act, 1935. - The Defence Act, 1962.
<b>Saint Kitts and Nevis</b>	- The Police Act, 2003. - Defence Act, 10,1997.
<b>Saint Lucia</b>	- Police Act, Chapter 14:01, 2001.
<b>Saint Vincent and the Grenadines</b>	- Police Act, 280
<b>Trinidad and Tobago</b>	- Defence Act, Chapter 14:01, 1962. - Police Service Act, Chapter 15:01, 2006.

Source: Compilation based on the mentioned legislation.

**Legal functions related to defence in the system**

GG: Governor General. PTE: President. PM: Prime Minister. DB: Defence Board.  
 CF: Chief of the Force. SC: Security Council. CP: Commissioner of Police.

Country	Commanded formally by	Directed by	Controlled through	Commission in another country authorized by	Command, administration and discipline	Responsible for Operations	Troop exit authorized by	Defence Board Members
<b>Antigua and Barbuda</b>	GG	PM	PM		DB	CF	GG	PM, JF, other to be designated.
<b>Bahamas</b>	GG	PM	Minister of National Security		SC	CF	GG	PM, Minister of National Security, other to be designated.
<b>Barbados</b>	GG	PM	--		DB	CF	GG	PM, Other Ministers to be designated.
<b>Belize</b>	GG	PM	Minister of Defence and Immigration	Minister	DB	CF	GG	Defence and Immigration Minister, JF, other ministers to be designated.
<b>Dominica</b>	PTE	PM	Minister for National Security, Labour and Immigration	--	CP	CP	--	--
<b>Grenada</b>	GG	PM	--	--	CP	CP	--	--
<b>Guyana</b>	PTE	PM	--	PM	DB	CF	PM with Parliament	PTE, PM, Minister of Home Affairs, JF, three other to be designated.
<b>Jamaica</b>	GG	PM	Minister of National Security		DB	CF	GG	Minister of National Security, JF, other minister to be designated.
<b>Saint Kitts and Nevis</b>	GG	PM	Minister of National Security		DB	CF	GG	PM, Minister of National Security, other to be designated.
<b>Saint Lucia</b>	GG	PM	Minister for Home Affairs and National Security	--	CP	CP	--	--
<b>Saint Vincent and the Grenadines</b>	GG	PM	Minister of National Security	--	CP	CP	--	--
<b>Trinidad and Tobago</b>	PTE	PM	Minister of National Security	Minister	DB	CF	PTE	Minister of National Security, JF, two other ministers to be designated.

Source: Compilation based on the defence and police force acts of each country. In the case of Dominica, Police Act, Chapter 14:01, 1940, reference is made only to responsibility for the police force.



## Organization of Defence and Security Forces

 Prime Minister's Office  
Royal Antigua and Barbuda Defence Force

 Personnel: 270

Regular Forces

- 1st Battalion
- Coast Guard
- Service and Support Unit

Reserve Forces

 Minister of National Security  
Royal Bahamas Defence Force

 Personnel: 1,061

Regular Forces

- Squadron
- Air Wing Department

Reserve Forces

 Prime Minister's Office  
Barbados Defence Force

 Personnel: 626

Regular Forces

- 1st Battalion
- Coast Guard
- Air Wing

Reserve Forces

 Minister of Defence and Immigration  
Belize Defence Force

 Personnel: 1,029

Regular Forces

- 1st and 2nd Infantry Battalion
- Service and Support Battalion
- Volunteer Battalion
- Air Wing Special Boat Unit
- National Coast Guard (1)

Reserve Forces

 Minister of National Security, Labour and Immigration  
Dominica Police Force

 Personnel: 444

Regular Forces

- Departments
- Marine Unit

 Prime Minister's Office (2)  
Royal Grenada Police Force

 Personnel: 836

Regular Forces

- Departments
- Coast Guard

(1) Independent from the Defence Forces.

(2) Ministry of National Security, Public Administration, Information, Technology Communications and Culture reporting to the Prime Minister's Office.



Office of the President  
Guyana Defence Force

---

 Personnel: 3,428

---

Regular Forces

- 1st and 2nd Infantry Battalion (Reserve)
- Service and Support Battalion
- Engineers Battalion
- Artillery Company

Coast Guard      Air Corps

---

Special Forces Squadron

Reserve Forces



Minister of National Security  
Jamaica Defence Force

---

 Personnel: 4,125

---

Regular Forces

- 1st and 2nd Battalion
- 3rd Battalion (Reserve)
- Service and Support Battalion
- Engineer Regiment

Coast Guard      Air Wing

---

Combat Support Battalion

Reserve Forces



Minister of Foreign Affairs, National Security, Labour, Immigration and Social Security  
Royal Saint Kitts and Nevis Defence Force

---

 Personnel: 375

---

Regular Forces

- Company
- Service and Support Platoon

Coast Guard

---

Reserve Forces



Minister of Home Affairs and Security  
Royal Saint Lucia Police Force

---

 Personnel: 947

---

Regular Forces

- Departments
- Marine Police



Minister of National Security  
Royal Saint Vincent and the Grenadines Police Force

---

 Personnel: 880

---

Regular Forces

- Rapid Response Unit
- Special Services Unit

Coast Guard



Minister of National Security  
Trinidad and Tobago Defence Force

---

 Personnel: 5,126

---

Regular Forces

- 1st and 2nd Infantry Battalion
- 3rd Engineering Battalion
- Service and Support Battalion

Coast Guard      Air Guard

---

Reserve Forces

**Sources:** Government of Antigua and Barbuda and Defence (Amendment) Act, 2007 (Antigua and Barbuda). Ministry of National Security (Bahamas). Barbados Defence Force and Defence Act, Chapter 159 (Barbados). Ministry of Defence (Belize). Ministry of National Security, Labour and Immigration (Dominica). Ministry of Finance of Grenada (Grenada). Office of the President and Defence Act Chapter 15:01 (Guyana). Ministry of National Security (Jamaica). Ministry of Foreign Affairs, National Security, Labour, Immigration and Social Security (Saint Kitts and Nevis). Saint Lucia Police Force (Saint Lucia). Ministry of National Security Air and Sea Port Development (Saint Vincent and the Grenadines). Ministry of National Security (Trinidad and Tobago). In all cases where defence forces exist, Reserve Forces are established besides the Regular Forces. In Antigua and Barbuda, Barbados, Dominica, Grenada, Saint Lucia, Saint Vincent and the Grenadines, there also exist Special Service Units, of a militarized nature, within the Regional Security System (RSS).



## The Cricket World Cup Test Cooperation and confidence in regional security

In 2007, the organization of the ICC Cricket World Cup in the Caribbean region gave way to an unprecedented level of cooperation with the result that many mechanisms and institutions, including IMPACS were created. The magnitude of the event (the final visitor count totalled 2,838,474) and the geographic dispersion of the venues represented the main challenge. Thus, already in July 2005, the CARICOM Conference of Heads of Government, following the recommendation of the ministers in charge of regional security, agreed to establish a framework for crime and security management in the region. With the creation of a Council of Ministers responsible for national security and the rule of law within the CARICOM a significant step was taken in this respect.

Based on these actions, the CARICOM Conference of Heads of Government agreed on the creation of a Single Domestic Space and mandated the organization of the Implementation Agency for Crime and Security (IMPACS), which became the main agency for the regional security strategy implementation during the Cricket World Cup. In the same manner as the preparations for the CWC were the starting point for the devising of a regional security strategy, the Cricket World Cup was the first functionality test for this new architecture.

Ad-Hoc Sub - Committee for Cricket World Cup 2007 Security

ICC Cricket World Cup WEST INDIES 2007

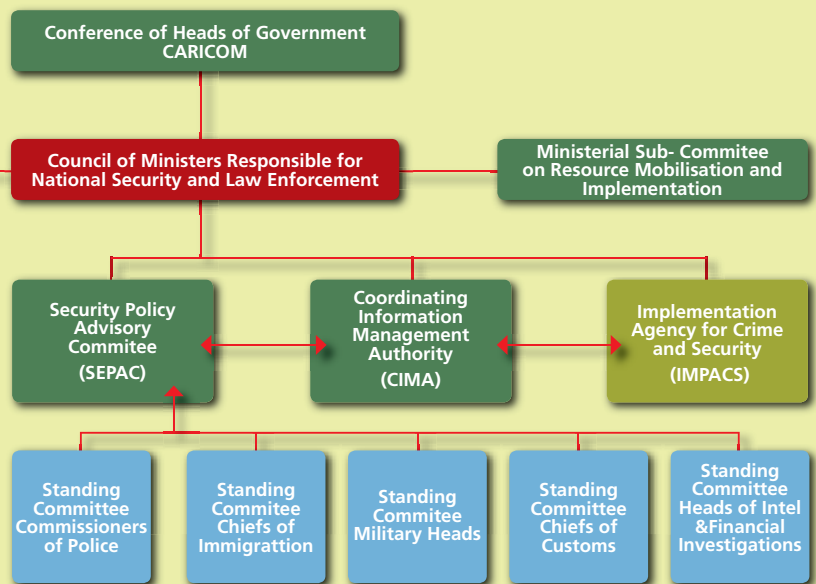

### The Single Domestic Space An unprecedented confidence building measure

The Single Domestic Space encompassed all nine countries (Antigua and Barbuda, Barbados, Grenada, Guyana, Jamaica, Saint Lucia, Saint Kitts and Nevis, Saint Vincent and the Grenadines, and Trinidad and Tobago) where the Cricket World Cup took place. Dominica decided to join in the initiative. It was implemented from January 15 to May 15, 2007. The Space implied that citizens of all these countries and other countries' nationals visiting from different parts of the world were free to move within the Space after completing migration formalities in the first port of entry. Visitors from different parts of the world took part, especially from Australia, Bangladesh, Canada, England, India, Nepal, Nigeria, New Zealand, Pakistan, Sri Lanka, South Africa and United States.

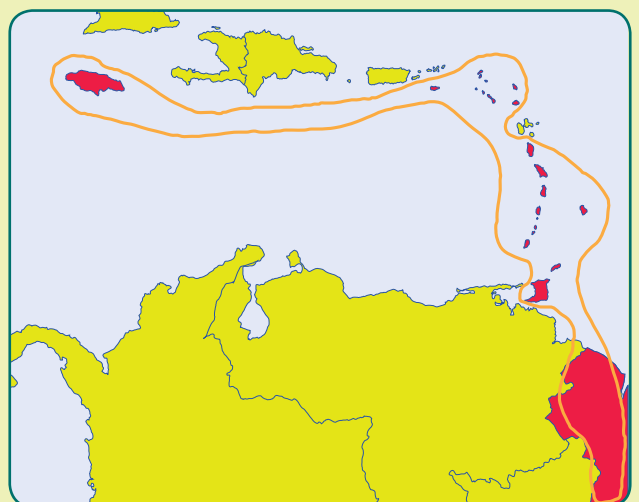



The preparations for the Cricket World Cup were the starting point for the devising of a Regional Security Strategy over geographically dispersed spaces and encompassed all CARICOM Member States.



**Regional Security Strategy**

**Intelligence sharing**

- Objectives: procedure standarization and officer training, strengthening of regional security and intelligence mechanisms and creation of a system to share intelligence.
- Once the Cup finished and owing to the successful organizational performance, the following entities were selected to remain in place permanently:

- Regional Intelligence Fusion Centre (RIFIC): combined work for the collection, analysis and dissemination of threats and intelligence information. The RIFIC acts as contact point with countries outside the CARICOM that took part in the CWC. It organized three courses on intelligence operations attended by 52 officers, among which RIFIC members were selected.
- CARICOM Intelligence Sharing Network (CISNET): facilitates secure sharing of intelligence reports, on-line meetings and videoconferences.
- CARICOM Watchlist System (CAWS): listing of criminals, International terrorists and other individuals of interest to the intelligence area.

**Regional Security Plan (June 2006)**

- Subjects addressed:
- Land, maritime and air operations.
  - International support.
  - Communications.
  - Logistics.
  - Personnel.
  - Humanitarian assistance training.
  - Public relations.
  - Finance.

Generated coordination mechanisms including the Regional Operation Coordination Center (ROCC) and the Regional Intelligence Fusion Centre (RIFIC).

Established cooperation with international agencies, including INTERPOL.

Created the CARICOM Operations Planning and Coordinating Staff (COPACS) to define the State instruments to provide the necessary support.

Established task forces associated with security of facilities, patrolling, force fast response and counterterrorism, among others.  
 North: led by Jamaica and the Regional Security System (RSS) to cover Antigua and Barbuda, and Saint Kitts and Nevis.  
 Center: Guyana, RSS and Bermuda to give support to Barbados.  
 South: Trinidad and Tobago and RSS to give support to Saint Vincent and the Grenadines, Grenada, and Saint Lucia.

**Border Security**

Facilitate free movement and transit of nationals of all countries across all borders, through:

- A common CARICOM visa policy. Visas were granted to 43,408 applicants and denied to 1,692.
- Advanced passenger and cargo information policy: Under charge of the Implementation Agency for Crime and Security (IMPACS), established the Joint Regional Communications Centre (JRCC) with which INTERPOL staff cooperated and 2,834,474 passengers were recorded.

**International Support Advisory Group (ISAG)**

- Established for the purpose of supporting mobilization of the resources required for the CWC. Comprised of representatives from Australia, Bermuda, Canada, France, India, The Netherlands, New Zealand, Pakistan, South Africa, the UK and the USA.
- Other countries, including Brazil, Colombia and France, in turn, lent their assistance.
- Netherlands and Venezuela cooperated with navy forces.

**Budget**

The total organization cost was US\$ 16,000,000

Elaborating a Regional Security Strategy required that all CARICOM Member States adapt or amend part of their internal legislations (mainly in matters associated with immigration, entrance and exit of foreign military and police men), in order to make the Cricket World Cup tournament possible in the region.

**Natural Disasters**

- Work was conducted with CDERA (currently CDEMA - Caribbean Disaster Emergency Management Agency-), in emergencies occurred as a result of a natural disaster.
- A subcommittee was established formed by the officials responsible for the matter in each country, presided over by the Saint Lucia Minister for Home Affairs
- Disaster simulation exercises were conducted under the coordination of the Humanitarian Allied Forces (FAHUM) and sponsored by the United States Southern Command. Also, two Tradewinds exercises were held.

Source: Compilation based on the work One Team, One Space, One Caribbean, CARICOM Implementation Agency for Crime and Security, 2007.





**Participation in regional organizations**

Anglophone Caribbean	Other dependencies and countries in the region	Latin America
Antigua y Barbuda	Anguilla (UK)	Colombia
Bahamas	Aruba (1) (NL)	Costa Rica
Barbados	Bermuda (UK)	Cuba
Belice	British Virgin Islands (UK)	Dominican Republic
Dominica	Curaçao (NL)	El Salvador
Grenada	Cayman Islands (UK)	Guatemala
Guyana	French Antilles (FR)	Haiti
Jamaica	Montserrat (UK)	Honduras
Saint Kitts and Nevis	Netherlands Antilles (1) (NL)	Mexico
Saint Lucia	Saint Martin (FR/NL)	Nicaragua
Saint Vincent and the Grenadines	Suriname	Panama
Trinidad and Tobago	Turks and Caicos Islands (1) (UK)	Venezuela
	Virgin Islands (USA)	

(1) Aruba, the Netherlands Antilles and Turks and Caicos Islands, along with France on behalf of the French Guyana, Guadeloupe and Martinique, are associated members. They have the right to participate and vote on issues directly affecting them and within their constitutional competence.

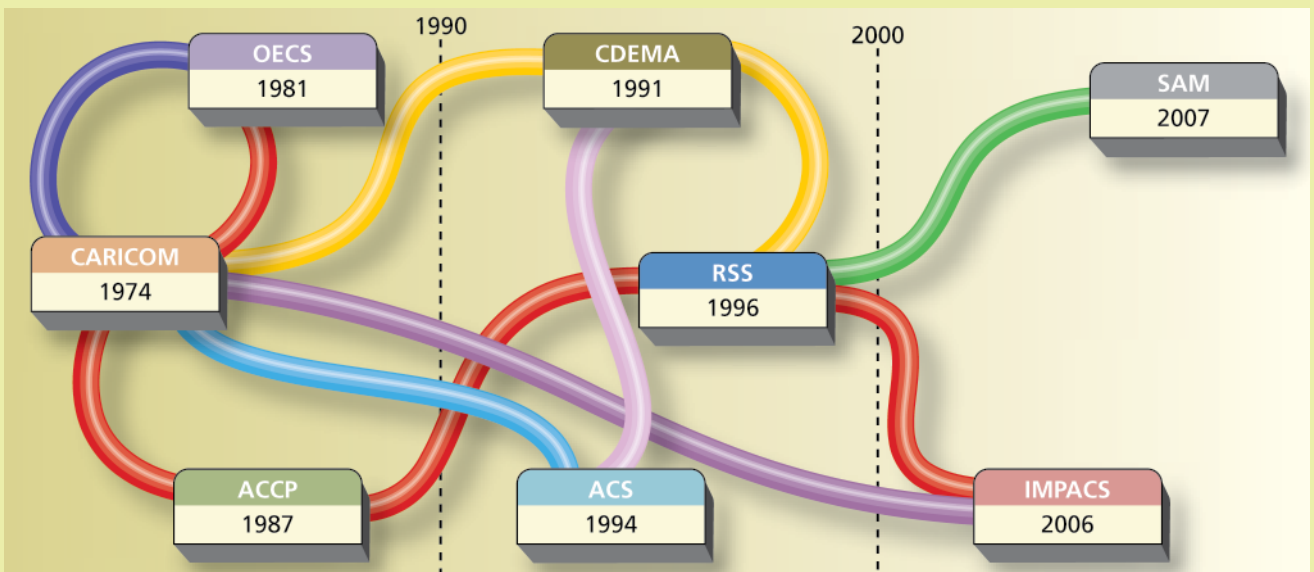

**CARICOM:** Caribbean Community.

**RSS:** Regional Security System.

**CDEMA:** Caribbean Disaster Emergency Management Agency

**ACCP:** Association of Caribbean Commissioners of Police

**IMPACS:** Implementation Agency for Crime and Security

**OECS:** Organisation of Eastern Caribbean States

**ACS:** Association of Caribbean States

**SAM:** Security Assistance Mechanism

— CARICOM is founder and observer of the ACS.

— Implementation Agency.

— Actors in the regional crime and security task force.

— Relation between Secretariats.

— Action upon natural disasters. CDEMA organizes CARICOM directives and the RSS is the executing body.

— The RSS acts as SAM's Executive Secretariat.

— Memorandum of Understanding on Natural Disaster Assistance and Relief.

**Source:** Compilation based on information posted on the websites of the mentioned institutions.

## Caribbean Disaster Emergency Management Agency (CDEMA)

The CDMA is an intergovernmental body created in 1991, by decision of the Heads of Government of CARICOM Member States. Initially created as CDERA (Caribbean Disaster Emergency Response Agency), in September 2009 it adopted the concept of emergency management, thus expanding their scope of action.

CDEMA and cooperation in the event of disaster represents another indicator of Caribbean area coordination and cooperation and their interrelation with Latin American countries.

### Functions:

- Mobilizing and coordinating disaster relief.
- Mitigating or eliminating, as far as possible, the consequences of disasters affecting Participating States.
- Providing immediate and coordinated response by means of humanitarian assistance to an emergency in any participating State.
- Securing, collating and channelling to interested governmental and non-governmental organizations, comprehensive and reliable information on disasters affecting the region.
- Promoting the adoption of loss reduction policies and practices at the national and regional levels and cooperative arrangements and mechanisms to facilitate the development of a culture of disaster loss reduction.
- Coordinating the establishment, promotion and maintenance of adequate disaster response capabilities among Participating States.

**Secretariat:** St. Michael, Barbados. Acts as Coordination Unit

**Board of Directors**  
Comprised of the coordinators of each national disaster management organization. It makes recommendations and provides technical advice to the Work Programme and the Budget and other political decisions that so require.

**Council:**  
It is the supreme political body. It is made of the Heads of Government of participating states and meets annually to review the agency's work, approve the work programme and make all the required political decisions.

The CDEMA obtains project financing from several organizations, including the Inter-American Development Bank, the Program of the United Nations for Development, and co-operation agencies from Austria, Canada, United States, United Kingdom, Japan and the European Union.

### National Organizations

<b>Antigua and Barbuda</b>	National Office of Disaster Services (NODS). Ministry of Health and Social Transformation.
<b>Bahamas</b>	National Emergency Management Agency. Prime Minister's Office.
<b>Barbados</b>	Emergency Management Department. Ministry of Home Affairs.
<b>Belize</b>	National Emergency Management Organization (NEMO). Ministry of Transport, Communications and National Emergency Management
<b>Dominica</b>	Disaster Management Office. Ministry of National Security, Labour and Immigration.
<b>Grenada</b>	National Disaster Management Association Agency (NADMA). Prime Minister's Office.
<b>Guyana</b>	Civil Defence Commission. President's Office.
<b>Jamaica</b>	Office of Disaster Preparedness and Emergency Management (ODPEM). Prime Minister's Office.
<b>Saint Kitts and Nevis</b>	National Emergency Management Agency (NEMA). Ministry of Foreign Affairs, National Security, Labour, Immigration and Social Security.
<b>Saint Lucia</b>	National Emergency Management Organisation. Prime Minister's Office.
<b>Saint Vincent and the Grenadines</b>	National Emergency Management Organisation. Ministry of National Security.
<b>Trinidad and Tobago</b>	Office of Disaster Preparedness and Management. Ministry of National Security.

**Note:** The list is completed with Anguilla (Department of Disaster Management), Turks and Caicos Islands (Department of Disaster Management and Emergencies), British Virgin Islands (Department of Disaster Management), Haiti (Civil Protection Directorate), Montserrat (Disaster Management and Co-ordination Agency) and Suriname (National Coordination Centre for Disaster).

### Emergencies in which the Agency has been involved

- Hurricane Andrew (Bahamas, 1992).
- Earthquake in Jamaica (1993).
- Tropical Storm Debby (Saint Lucia, 1994).
- Floods in Barbados (1995).
- Hurricane Louis (East of the Caribbean, 1995).
- Volcano in Montserrat (1995 - 1996).
- Hurricane Georges (North of the Caribbean, 1998).
- Hurricane Lenny (East of the Caribbean, 1999).
- Hurricane Keith (Belize, 2000).
- Hurricane Ivan (Grenada, 2004).
- Hurricane Jeanne (Bahamas, 2004).
- Floods in Guyana (2005).
- Hurricane Dean (Dominica, Jamaica, 2007).
- Hurricane Ike (Turks and Caicos Islands, 2008).
- Earthquake in Haiti (2010).



**Source:** Compilation based on information supplied on the Caribbean Disaster Emergency Management Agency website.



## Implementation Agency for Crime and Security (IMPACS)

**Seat:** Port of Spain, Trinidad and Tobago.

It is the operational centre of CARICOM crime and security management structure and main responsible organization for the implementation of the agenda against crime and security. Among its functions it is daily reporting to the Council of Ministers responsible for these matters. It is focused on projects related to security affairs management and investigation.

In 2001, the Conference of the Heads of Government of CARICOM, at their XXII meeting held in Nassau, Bahamas, established a Regional Task Force to examine the main causes of crime and make recommendations to cope with interrelated problems, including trafficking of drugs and fire arms, and terrorism.

In June 2005, a formal structure was established for the Agency at the XXVI Meeting of the Conference of the Heads of Government of CARICOM. By means of an inter-governmental agreement, the IMPACS was created in July 2006. The IMPACS worked in a limited way until January 2007, when it started to operate as it is known today.

IMPACS has two sub-agencies: **The Joint Regional Communications Centre (JRCC)** and the **Regional Intelligence Fusion Centre (RIFC)**. These agencies were created for the purpose of supporting the Regional Security Strategy during the Cricket World Cup. As a result of their success, in February 2007, the Conference of Heads of Government endorsed a proposal for their permanent establishment.

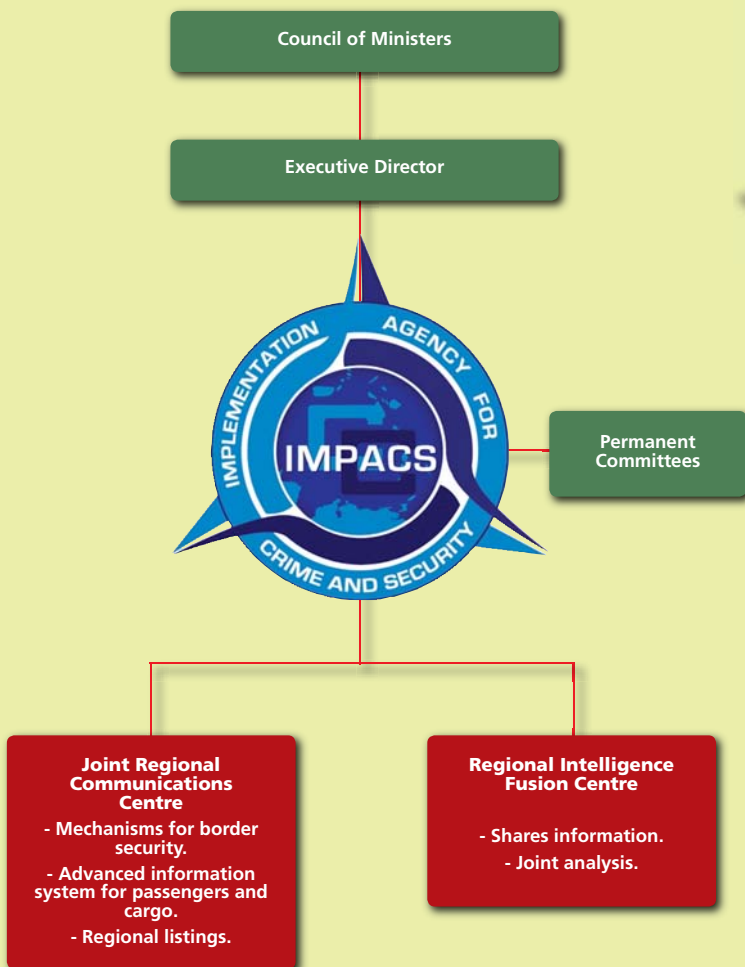

### Permanent Committees

- Commissioners of Police and Chiefs of Military.
- Chiefs of Immigration and Customs Comptrollers

### Association of Caribbean Commissioners of Police (ACCP)

Year of creation: 1987  
 Denomination: Association of Caribbean Commissioners of Police  
 Mission: Promoting and facilitating cooperation in the development and implementation of policing strategies, systems and procedures. Also, police technical skills development and proactive measures to prevent crime and improve police-community relations. Meetings are held every year.  
 Members: Antigua and Barbuda, Bahamas, Barbados, Belize, Dominica, Grenada, Guyana, Jamaica, Saint Kitts and Nevis, Saint Lucia, Saint Vincent and the Grenadines, and Trinidad and Tobago.

Source: Compilation based on information supplied by the Association of Caribbean Commissioners of Police, and IMPACS.

## Regional Security System (RSS)

The Regional Security System (RSS) was created in 1996. It is a collective security system by means of which members agreed that any armed attack against any of them, whether by a third State or other sources, represents an armed attack against all of them. As an organization it is a 'hybrid': Security forces are comprised of military and police personnel.

**Mission:** To ensure the stability and well-being of Member States through mutual cooperation, in order to maximise regional security in preserving the social and economic development of the people.

**Functions:** Promote cooperation in the prevention and interdiction of traffic in illegal narcotic drugs, national emergencies, search and rescue, immigration control, fisheries protection, customs control, maritime policing duties, natural and other disasters, pollution control, combating threats to national security, prevention of smuggling, and protection of off-shore installations and exclusive economic zones.

**Secretariat:** Permanent, with seat in Bridgetown, Barbados. It is headed by a Regional Security Coordinator (Mr. Grantley Watson in 2010), appointed by the Council of Ministers and assisted by the Joint Coordination Committee, made up of seven Commissioners of Police and three military commanders of the Defence Forces of the Member States.

**Central Liaison Office:** It is the Secretariat to the Security Assistance Mechanism established by CARICOM. In addition, the CLO coordinates disaster response on behalf of the CDEMA, activating the Caribbean Disaster Relief Unit (CDRU) for such purpose. The Unit consists of a special corps of defence and police men and women of CARICOM countries.

**Budget:** US\$ 4,780,848 for fiscal year 2009-2010. Provided by Member States.

**Troops:** Based in each Member State. The combination of police and military staff totals 9,300 personnel.

### Background:

1982: Memorandum of Understanding (MOU) signed by four members of the Organization of Eastern Caribbean States (Antigua and Barbuda, Dominica, Saint Lucia, and Saint Vincent and the Grenadines) and Barbados, to provide for mutual assistance on request.

1983: Saint Kitts and Nevis adhered to the MOU.

1985: MOU signing by Grenada.

### El RSS Air Wing and the Air Operations Centre

The Regional Security System's Air Wing was established in 1999 with direct US assistance. Since 2006, it is fully financed by the System itself. It works mainly in:

- Air surveillance (it has two C-26 aircraft available -donated by Barbados).
- Assistance to States in the fight against drug trafficking.
- Assistance in the event of disasters.
- Search and rescue.
- Logistics support to exercises and operations.

The Air Operation Centre conducts an average of twenty monthly operations, especially anti-narcotics. The dialogue to establish a similar structure for the Coast Guard is well advanced.

### Exercises and Relations

It conducts exercises for member states and with other countries of the region and of the world: the UNEX (internal exercise to test mobilization plans), and three other in cooperation with the US Southern Command (Tradewinds – air-, PKO North –peace operations-, and FAHUM –disaster assistance).

It has relations with:

- Countries: Brazil, Canada, United States, United Kingdom, French, Netherlands and British territories in the area and, naturally, all CARICOM countries.
- Organizations: CARICOM, CCLEC, CDEMA, INTERPOL, United Nations, OAS and European Union.

### Training

The Training Unit has its seat in Antigua and Barbuda and works mainly in maritime training. It was financed by the United Kingdom until March 2008. Afterwards, the System has been self-supported.

Land force training is geared to Special Service Units (SSU). It is militarized and is partly conducted in Barbados and partly in other Member States when land characteristics so require.

### Security Assistance Mechanism

In July 2006\* twelve Anglophone Caribbean countries (Antigua and Barbuda, Bahamas, Barbados, Belize, Dominica, Grenada, Guyana, Jamaica, Saint Lucia, Saint Kitts and Nevis, Saint Vincent and the Grenadines, and Trinidad and Tobago) signed together with Suriname and the Regional Security System (RSS) a treaty establishing a security assistance mechanism. The Treaty represents a link among different spaces (the RSS and States that do not belong to it, the Anglophone Caribbean and Suriname).

Objectives:

- Disaster response.
- Regional resource mobilization and deployment for national and regional crisis management and fight against crime.
- Combat and elimination of threats to national and regional security.
- Preservation of the territorial integrity of participating States.

A Joint Coordination and Strategic Planning Committee, comprised of the Regional Security System (RSS) Coordinator and the Security Chiefs of the Member States, has been established for its implementation. Where defence forces exist, both their commander and the commander of the police force are part of the Committee.

\* The signing by the various countries occurred gradually since that date and continued through 2007.

Source: Treaty Establishing the Regional Security System (05/03/1996) and information provided by the RSS Permanent Secretariat (Central Liaison Office, Barbados).



## Strategic Links and International Assistance

### The International Military Education and Training (IMET) Program

The set objective is the defence understanding and cooperation between the United States and countries by increasing military force capabilities. The IMET provides professional training and scholarships to both civil and military students. Their program includes over 4,000 courses in 150 military schools, and involves about 7,000 students per year.

Participating countries: Antigua and Barbuda, Argentina, Bahamas, Barbados, Belize, Bolivia, Brazil, Chile, Colombia, Costa Rica, Dominica, Dominican Republic, Ecuador, El Salvador, Grenada, Guatemala, Guyana, Haiti, Honduras, Jamaica, Mexico, Nicaragua, Panama, Paraguay, Peru, Saint Kitts and Nevis, Saint Lucia, Saint Vincent and the Grenadines.

### Caribbean-Canada

There exist bilateral treaties for mutual legal assistance in criminal matters between Canada and Caribbean countries, including Bahamas, Jamaica, and Trinidad and Tobago.

### Military Training Assistance Program (MTAP) - Canada

It emerged from agreements signed in the early 1960s to provide military training assistance to certain recently independent Caribbean nations. It includes education to foreign students in Canada and offers advisory teams to member countries. Funds were assigned to the Program to contribute to the construction of the Jamaica Military Aviation School (JMAS), which is used for training to other countries in the region.

Participating countries: Antigua and Barbuda, Argentina, Barbados, Belize, Bolivia, Brazil, Chile, Dominican Republic, Ecuador, El Salvador, Guatemala, Guyana, Honduras, Jamaica, Mexico, Nicaragua, Paraguay, Peru, Trinidad and Tobago and Uruguay.

### Caribbean-United States

Bilateral treaties in force provide for assistance in the fight against drug-trafficking and other criminal matters between the United States and the Caribbean countries Antigua and Barbuda, Bahamas, Barbados, Dominica, Belize, Saint Kitts and Nevis, Saint Vincent and the Grenadines and Trinidad and Tobago.

### Strategic links and international assistance to organizations

Organization	Program	Counter party
CARICOM	Security Cooperation Plan	United Kingdom
CARICOM	Ministerial Forum	United Kingdom
CARICOM	CDEMA	Austria, Canada, United States, United Kingdom, Japan and European Union
CARICOM	IMPACS	European Union United States
RSS	Exercise and Training	United States, United Kingdom

### Caribbean-France

Exercises are conducted by military forces from France and the Caribbean countries Jamaica and Trinidad and Tobago, aside from maritime anti-narcotics operations with Trinidad and Tobago.

## Defence in the Anglophone Caribbean

### Dion Phillips

University of the Virgin Islands.

Defence in the Anglophone Caribbean in contemporary time has its antecedents in the insertion of the British military in what was then referred to as the West Indies in the 17th century. This pattern took the form of garrisons, the militias and even fortifications. However, since the demise of the Federation in 1962 and acting on nationalist impulses, Anglophone Caribbean states have opted for national defence forces. These forces as a whole have been small, not well funded and dependent on foreign assistance from the US, Britain, Canada and to a lesser extent, China, for their training, development and survival. At the outset, most of the regular military or defence forces of the Anglophone Caribbean were clearly established for external defence. However, this emphasis has been downgraded if not dropped in favour of an emphasis on internal security at the local level or in a neighbouring Caribbean territory as well as for relief operations, particularly for hurricanes.

By the middle of the 17th century, Britain established permanent colonies of settlement in the An-

glophone Caribbean (also called the British West Indies), examples of which are St. Christopher (better known as St. Kitts) in 1624, Nevis in 1628, Montserrat and Antigua in 1632 and Jamaica in 1655.<sup>1</sup> By so doing, Britain was responsible for the defence of these colonies even though they were expected to provide for their own internal security and a holding force against rivals.<sup>2</sup> Formed under the control of the colonial government, militia forces existed until the aboli-

1 The Anglophone Caribbean group of states is the smallest of the smallest in the Western Hemisphere. Even the next smallest, its Central American neighbours in the Caribbean Basin, are larger. It refers to the English-speaking countries of the Caribbean littoral: Antigua and Barbuda (1980), Bahamas (1973), Barbados (1966), Belize (1981), Dominica (1978), Grenada (1974), Guyana (1966), Jamaica (1962), St. Kitts and Nevis (1983), St. Lucia (1979), St. Vincent and the Grenadines (1979) and Trinidad and Tobago (1962). These countries were all under British colonial rule and gained their independence in the year that is provided. Bermuda and Montserrat are in effect internally self-governing. However, defence and foreign affairs remain the responsibility of Britain.

2 Richard A. Preston. *Canada and "Imperial Defense": A Study of the Origin of the Commonwealth's Defense Organizations, 1869-1919*, (Durham, N. C.: Duke University Press, 1967), 7.

### Caribbean Basin Security Initiative

The resources initially used to finance the Merida initiative include funds for Mexico, Central America, Dominican Republic and Haiti. For 2010, the United States administration proposed a new security system for the Caribbean: the Caribbean Basin Security Initiative (CBSI).

Objective: designed to strengthen the capabilities of Caribbean countries, including maritime security, law enforcement, information sharing, border control and migration, transnational crime and criminal justice.

Participating countries: Antigua and Barbuda, Bahamas, Barbados, Belize, Dominica, Dominican Republic, Grenada, Guyana, Haiti, Jamaica, Saint Kitts and Nevis, Saint Lucia, Saint Vincent and the Grenadines.

#### Matters

- Financing through the Global Conflict Prevention Pool (GCPP).
- Support to security sector reform, and (civil, police and military) leadership.

- Main dialogue vehicle between the parties.
- Coordination of different matters including civil defence and security.

Natural disaster response.

Funds for institutional strengthening.

IMPACS Implementation.

Assistance in courses related to drug-trafficking combat, imparted to civilians, and military and police officers.

<sup>1</sup> Only European Union and governmental cooperation agencies are included. The contributions of multinational and non-governmental organisations are not included. Source: websites of Caribbean organisations, United States Department of State, United Kingdom Foreign & Commonwealth Office, Guyana Government Information Agency, National Defence and the Canadian Forces, Embassy of China in Barbados; and information supplied by the ministries of Bahamas, Jamaica, and Trinidad and Tobago.

### Caribbean-China

China has in place an agreement for the free provision of military assistance with Barbados, and an agreement for the provision of military training and equipment with Guyana.

### Caribbean-United Kingdom Security Cooperation Plan

In 2004 a Plan was approved to supply a more coordinated and strategic approach to joint operations for security in the region. The GCPP is a source of financing through which the United Kingdom offers assistance in a variety of areas, including the reform of the security area, leadership training, and prison system reform.

Regional projects implemented since 2003:

- Leadership and command training for high defence and security officers (customs, police, military).
- Security force training.
- Training of prison staff leaders and review of penitentiary systems to meet United Nations minimum standards.
- Workshops for Public Defenders' Office Directors.

tion of slavery (1838), except for Jamaica.<sup>3</sup>

However, due to their size and training, these forces could never hope to provide adequate defence in times of war. Hence, the defence of the islands and other territories really depended upon the sea power of the Royal Navy. Also, because the militia forces were not always capable of maintaining internal order, especially when confronted by uprisings of some magnitude, they were reinforced by regular troops stationed in the colony and elsewhere in the region. The configuration of this defence took the form of British soldiers arriving in the West Indies in 1652.<sup>4</sup>

This incipient insertion of ground forces must be understood with the knowledge that English soldiers tended to follow English settlers, with the ensuing garrisons serving as instruments of social order. During this period, English colonial society largely determined the nature of defence. The British garrison in the West

<sup>3</sup> The militias were also mobilized during wars or threat of invasion to assist the defence of the colonies. In the case of Jamaica, its militia existed until the 1860s because Jamaica, unlike Guyana (formerly British Guiana) and Trinidad, was not a crown colony but enjoyed "representative government."

<sup>4</sup> Roger Norman Buckley, *The British Army in the West Indies: Society and the Military in the Revolutionary Age*, (Miami, Florida: University Press of Florida, 1998), xiii.

Indies had a critically important function, namely, the protection of the region's then profitable plantation economics. The post-emancipation period demanded new arrangements for maintaining internal security. Militia forces, originally recruited from free whites, were inappropriate for societies where formal universal freedom prevailed. And so, for the maintenance of internal order, the British required the development of police forces as well as volunteer forces in the 1870s and beyond.

Up to the time of World War II, all troops in the British West Indies were under the Northern Caribbean Command with its headquarters in Jamaica or the South Caribbean Command with its headquarters in Trinidad. After the war, the British government initiated the process of granting relative authority to its West Indies colonies as a result of the lack of resources necessary to maintain the British Empire as well as due to the great expenditure and the effects of the war. In 1958, the Anglophone Caribbean countries created the West Indies Federation on the initiative of the British government but controlled by the West Indies. Its headquarters was located in Trinidad, with Port-of-Spain as its capital. The intent was to establish a loose



## Strategic links - Excercises

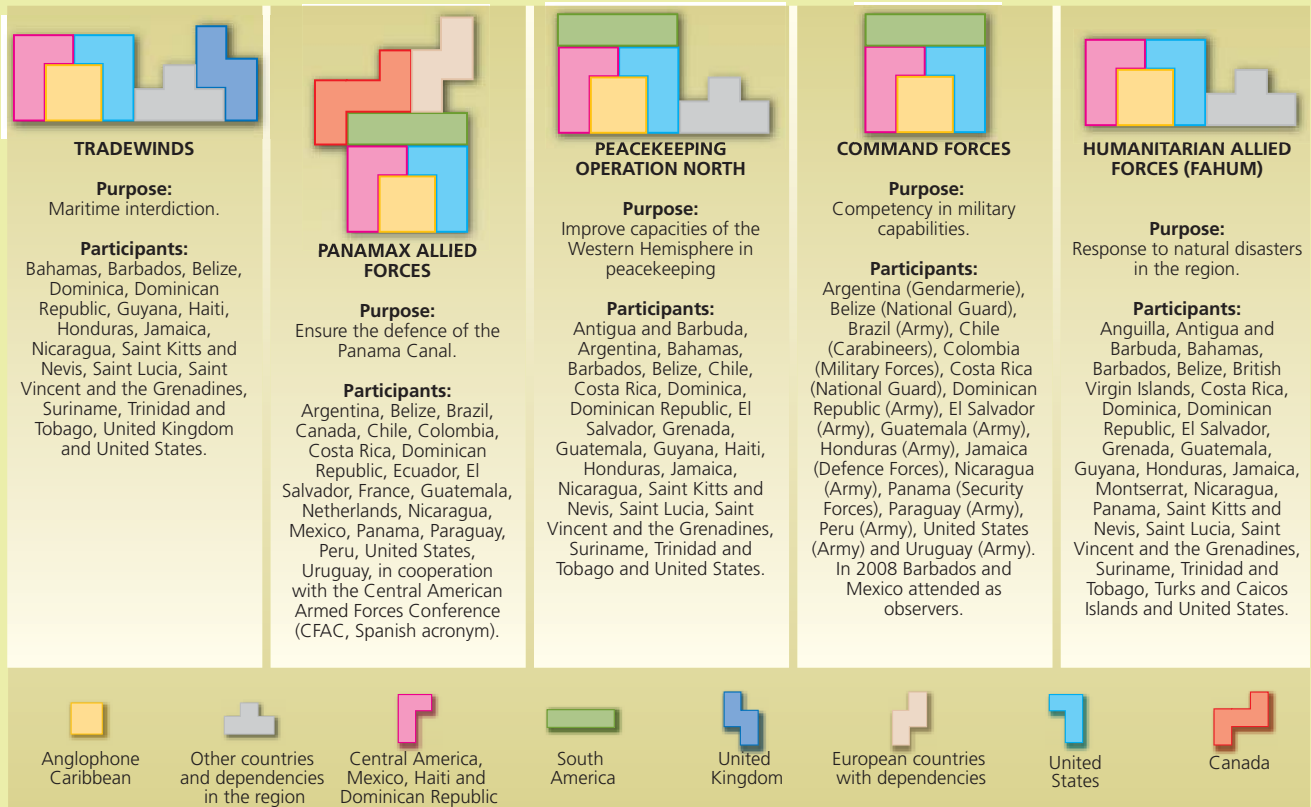

Source: Compilation based on information supplied by the US Southern Command.

Dion Phillips / Defence in the Anglophone Caribbean

federation aimed at fostering political and cultural solidarity and breaking down the barriers between the islands.<sup>5</sup> The defence arm of the West Indies Federation was the Federal West Indies Regiment (FWIR) formed in 1959.

Before the establishment of the FWIR, troops in the sub-region existed in Barbados, Trinidad and Tobago and Jamaica. Barbados had had a small regular regiment of reserves but in Trinidad and Tobago, the only serving officer was Captain Josette Serrete who returned in the mid-1950s as Garrison Quartermaster. In Jamaica, no regular black troops existed before 1926, except the Jamaica Military Band which was started in 1927 and remains active. Defence rested solely on British troops until 1938 when the Jamaica Infantry Volunteers, which later became the Jamaica Regiment, was established. However, in December 1958, the Federal Legislature passed the Defence Act. The act revived the regiment on January 1, 1959, to serve as the nucleus of the military arm of the West Indies Federation. Consequently, the pre-existing Jamaica Regiment was integrated into the Federal Defence Force to become the FWIR.

<sup>5</sup> David Killingray, "The West Indian Federation and Decolonization in the British Caribbean", *Journal of Caribbean History*, vol. 34, no. 1 & 2 (2000): 71.

### Post-West Indies Federation and Regional Defense

In the aftermath of the demise of the West Indies Federation in 1962, the Anglophone Caribbean's efforts at cooperation and integration displayed little concern with regional defence. Once political integration had eroded, it was virtually impossible to maintain the level of coordination and centralized defence policy that was once the goal of the Federation. In the same way that emerging nationalism had fragmented the West Indies Federation, so too did the impulse for national defence forces serve to replace the FWIR. And so, in the relatively free environment of the 1970s, regional defence was regarded by the Caribbean governments as peripheral and hence, beginning with Jamaica in 1962, followed by Trinidad and Tobago in that very year, several of the territories became independent and established separate defense forces. In fact, one of the preconditions for formal independence of the new Anglophone Caribbean states as imposed by Britain was the establishment of a defence force.

After 1962, economic issues overshadowed all other concerns and the Caribbean appeared to be secure in a turbulent world. The birth of CARIFTA in 1973 once again provided a framework for a collective defence

### Association of Caribbean States (ACS)

The Convention Establishing the Association of Caribbean States (ACS) was signed on 24 July 1994 in Cartagena de Indias, Colombia, with the aim of promoting consultation, cooperation and concerted action among all the countries of the Caribbean. The main organs of the Association are the Secretariat and the Ministerial Council, made up of the Ministers of Foreign Relations of the Member Countries. The Ministerial Council is in charge of policy-making and the conduct of the Association, and meets every year since 1995. The XV Ministerial Council Meeting took place in January 2010.

**Members:** Antigua and Barbuda, Bahamas, Barbados, Belize, Colombia, Costa Rica, Cuba, Dominica, Dominican Republic, El Salvador, Grenada, Guatemala, Guyana, Haiti, Honduras, Jamaica, Mexico, Nicaragua, Panama, Saint Kitts and Nevis, Saint Lucia, Saint Vincent and the Grenadines, Suriname, Trinidad and Tobago and Venezuela.

**Associated Members:** Aruba, France (on behalf of the French Guiana, Guadeloupe and Martinique), Netherlands Antilles and Turks and Caicos Islands.

**Observers:** Argentina, Brazil, Canada, Chile, Ecuador, Egypt, Finland, India, Italy, Korea, Morocco, Netherlands, Peru, Russia, Spain, Turkey, Ukraine, and United Kingdom.

### Summit of the Americas

Declaration of the V Summit of the Americas, Trinidad and Tobago, 2009:

- Addressing the threats to security, according to the priorities of each State, and strengthening cooperation bonds in the matter (Art. 68).
- Condemnation to terrorism (Art. 69).
- Fight against organised crime and illicit trafficking of drugs, arms, etc. (Art 70).

**Guyana** is a member and Pro Tempore President of the UNASUR South American Defence Council for 2010-2011.

### Central America Integration System (SICA)

The Secretaries-General of the Central America Integration System (SICA, Spanish acronym) and of the Caribbean Community (CARICOM), during the First Meeting of the CARICOM Conference of Heads of Governments and the SICA plus the Dominican Republic (2007), agreed upon an action plan to develop human and institutional capabilities needed to adequate responses to natural disaster vulnerabilities. In the matter of security, they undertook to discuss the possibility of adopting mechanisms for sharing crime information and condemned terrorism in all forms.

**Source:** Convention establishing the Association of Caribbean States, 1994. Action Plan of the Commonwealth of the Caribbean and the Central America Integration System, 2007. V Summit of the Americas, Declaration of Commitment of Port of Spain, 2009.

**Summit of Latin America and the Caribbean on Integration and Development (CALC)**  
Objective: promote further regional integration.

Antigua and Barbuda, Bahamas, Barbados, Dominica, Grenada, Saint Lucia, Saint Kitts and Nevis, Saint Vincent and the Grenadines, and Trinidad and Tobago.

**Rio Group**  
Objective: expand and systematize the political cooperation among member states  
Argentina, Belize, Bolivia, Brazil, Chile, Colombia, Costa Rica, Cuba, Dominican Republic, Ecuador, El Salvador, Guatemala, Guyana, Haiti, Honduras, Jamaica, Mexico, Nicaragua, Panama, Paraguay, Peru, Suriname, Uruguay and Venezuela.

### Unity Summit of Latin America and the Caribbean

Seeks to consolidate and project, at global level, Latin American and Caribbean identity based on the following common principles and values, among others:

- the respect for international law.
- the sovereign equality of States.
- the non use nor threat of use of force.
- democracy.
- the respect for human rights.
- respect of the environment, taking into consideration the environmental, economic, and social pillars of sustainable development.
- the unity and integration of Latin-American and Caribbean countries
- an ongoing dialogue that promotes peace and regional security.

**Note:** The I Summit of Latin America and the Caribbean on Integration and Development (CALC, Spanish acronym) was held in Salvador, Brazil, on December 16 and 17, 2008. The Rio Group was created on December 18, 1986. The Unity Summit of Latin America and the Caribbean was created by the XXI Summit of the Rio Group and the II Summit of Latin America and the Caribbean on Integration and Development on February 22 and 23, 2010, Riviera Maya, Mexico.

**Source:** Summit of Latin America and the Caribbean, Declaration of Salvador de Bahia, 2008. Rio Group, Declaration of Rio de Janeiro, 1986. Unity Summit of Latin America and the Caribbean, Declaration of the Unity Summit of Latin America and the Caribbean, 2010.

policy. CARICOM, the successor to CARIFTA, lacked the political cohesion necessary for the direction of an inclusive defence policy in the way that the West Indies Federation was coordinated by the Federal parliament. The predominance of national interest over regional considerations took precedence and served as an obstacle to any CARICOM-wide regional defence mechanism. A CARICOM defence force remained but a fleeting idea in the midst of the plethora of national defence forces that exist throughout the Caribbean sub-region.

In December of 1979, there was the temporary seizure of state power in Union Island in the Grenadines which prompted the signing of an MOU that later led to the establishment of the Organization of Eastern Caribbean States (OECS) Defence and Security Committee in July 1981. This Defence and Security Committee of the OECS, established under Article 8 of the Treaty, was charged with coordinating collective defence. Barbados, the strongest militarily of the Eastern Caribbean states, was not included. Two factors served as catalysts to revive the need for defence and regional security cooperation, namely, the coming to power of the socialist People's Revolutionary Government (PRG) of Grenada in March 1979 as well as the perception of the

US of this development. As a result, the Regional Security System (RSS) was formed on October 29, 1982 by the member-states that were party to the OECS as well as Barbados. The special arrangement was the second time since World War II that the Anglophone Caribbean had adopted a coordinated and centralized approach to defence policy.

In view of the crisis that had developed in Grenada on 19 October 1983, the OECS formally notify Britain and the United States of the decision to take joint action to restore order in Grenada. Subsequently, a more formal request for US assistance was made in writing in October 23. An OECS emergency session was held in Trinidad and Tobago but CARICOM heads of government were unable to reach a consensus on the proposal for joint action in Grenada. They agreed only to impose sanctions on Grenada, including suspension of its CARICOM membership. It was the OECS countries as well as Barbados and Jamaica who actively supported the joint US-Caribbean operation on October 25, 1983 called Operation Urgent Fury, although three OECS members –Grenada, St. Kitts and Montserrat- did not participate in the voting. After the Grenada operation, the US, Britain and neighbouring states began to rebuild Grenada's security forces.





• On July 30, 1974, a Cooperation Agreement was signed by Mexico and the Caribbean Community under which the CARIOM-Mexico Joint Commission was created.

• The Cuba - CARICOM Summit is held every year an half since 2005.

The US also began to increase its military training assistance to the RSS member states. It trained SSU personnel on each of the RSS islands, including the newly independent St. Kitts and Nevis and, along with Britain and Canada, started to develop and equip the coast guards of the region.

In response to the creation of the RSS and the SSUs, some elements in the Eastern Caribbean charged that these measures were designed by the US to keep conservative, pro-US governments in power. In addition to the regional debate concerning the advisability of establishing the RSS, two other related security concerns emerged in the 1980s. One was the proposal to establish a regional defence force, revived by Barbadian Prime Minister Tom Adams. The other was the charge being made that the Eastern Caribbean was being militarized. Plans to establish a regional defence force date back to the 1960's and again in April 1979, John Compton, then Premier of St. Lucia, put forward a proposal that the embryonic OECS include, in addition to its political and economic arms, a sub-regional defence force. This was in part a reaction to the Grenada coup in March 1979, but because of differences over that and other practical obstacles the proposal made little headway.

The idea of a region-wide regular army was rejected as too costly. The creation of such a regional defence force, at the time, would have been unprecedented for a sub-region that had been guarded largely by police since the islands became independent from Britain in the 1960s. Again, in February 1984, the RSS Council of Ministers, meeting in Bridgetown, studied a report on the implications of establishing a regional security force that did not include Trinidad and Tobago. By that time, the proposal envisioned an 1,800-member force costing US\$100 million over 5 years. This figure included the purchase of coast guard vessels and helicopters. The idea was stillborn, again due to its cost. Rather, the emphasis was placed on the creation of SSUs in each RSS country. The thrust for Caribbean regional security in the form of a standing army never materialized. In fact, regional security cooperation took the form of exercises<sup>6</sup>, and the charges of militarization were sidelined,

<sup>6</sup> Humberto García Muñoz, *Boots, Boots, boots: Intervention, Regional Security and Militarization in the Caribbean 1979-1986*, (Río Piedras, Puerto Rico: Proyecto Caribeño de Justicia y Paz, 1986).

particularly as the RSS got involved in the mitigation of hurricanes, beginning with 'Hugo' in Jamaica, which resulted in a great deal of goodwill towards the forces. However, the call for greater regional security cooperation again emerged in the aftermath of the Jammal al Muslimeen's insurrection against the ANR Robinson government in Trinidad in July 1990. It was Barbados' Prime Minister Erskine Sandiford, at the 11th Heads of Government Summit in Jamaica in 1990, who made a plea for the implementation of a system of closer cooperation in collective matters.<sup>7</sup> The meeting was held without the then Prime Minister of Trinidad and Tobago, who had been wounded by gunfire and held hostage in parliament during the assault. The following year, Sandiford indicated that three studies on regional security had been commissioned and disclosed that they had been done by the CARICOM Secretariat, the RSS and the Barbados government. In March 1996, the RSS MOU, which was updated in 1992, acquired juridical status in March 1996 under a treaty which was signed at St. George's, Grenada.

The affordability consideration has also been a constant in defence policy formation. From the days of scepticism toward funding for the FWIR in the 1950s, Anglophone Caribbean countries, constrained as they are by their limited resources, have always had leaders who view alleviating the social conditions of their peoples as a foremost priority area of action. Some Anglophone Caribbean countries, particularly the OECS, have tended not to invest in defence while the larger countries did. The general trend is that defence budgets are low compared to education for example. This proclivity has created a dependence on donations, mainly from the United States, Britain, Canada and even China, to fund training programmes, carry out maintenance and make acquisitions.

<sup>7</sup> Address by L. Erskine Sandiford, Prime Minister of Barbados to 1990 CARICOM summit in "Communiqué and Addresses—Eleventh Meeting of the Heads of Government of the Caribbean Community", *CARICOM Perspective Special Supplement*, 49 (July-December 1990): 6.

# THE COUNTRIES

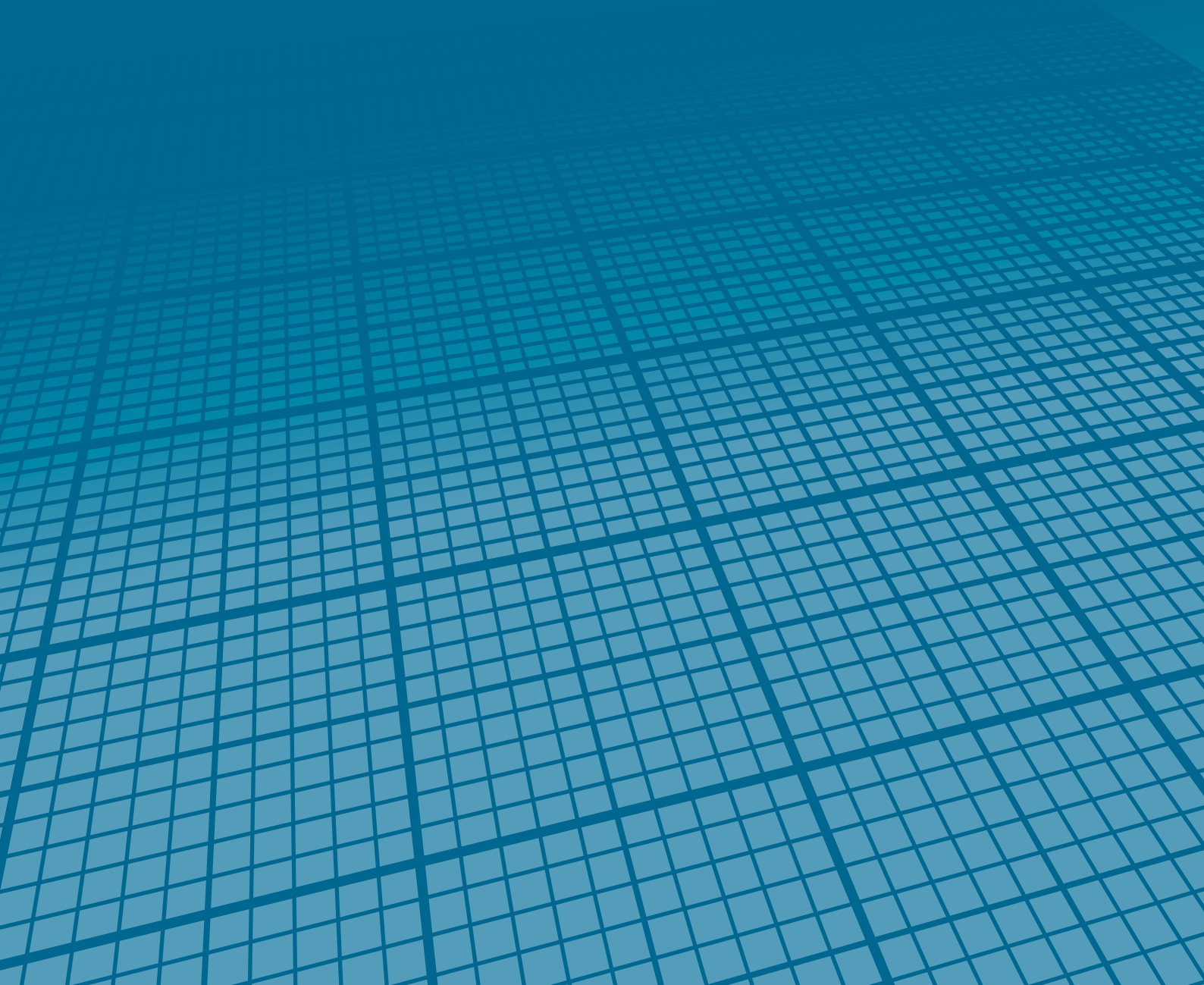



# Argentina

## The Legal Framework and the Defence System

### National Legislation

#### Systems and Concepts

- National Defence Act (N° 23.554 - 1988/05/05)
- Internal Security Act (N° 24.059 - 1992/01/17)
- Ministerial Law (N° 22.520 - 1992/03/20)
- Act on the Restructuring of the Armed Forces (N° 24.948 - 1998/04/08)
- National Intelligence Act (N° 25.520 - 2001/12/06)

#### Military Organization

- Military Service Act (N° 17.531 - 1967/11/16)
- Military Personnel Act (N° 19.101 - 1971/07/19)
- Financial Aid Institute Act for Pension and Retirement Payments (N° 22.919 - 1983/09/26. Last amendment: Decree N° 860-2009/07/07)
- Voluntary Military Service Act (N° 24.429 - 1995/01/10)
- Act on the Entry of Foreign Troops and the Deployment of National Troops outside the Country (N° 25.880 - 2004/04/23)
- Act which derogates the Code of Military Justice, approves reforms to the Criminal Code and to the Criminal Code of Procedures of the Nation; it also approves Instructions to Civilians in War Times and in other Armed Conflicts, as well as the Armed Forces Code of Discipline and the Organization of the Joint Justice Service of the Armed Forces (N° 26.394 - 2008/08/26)

**Source:** Compilation based on the legislation above mentioned. For constitutional provisions see Chapter 1.

- Advisory and assistance functional relationship
- Command reporting line
- - - Joint planning and management relationship

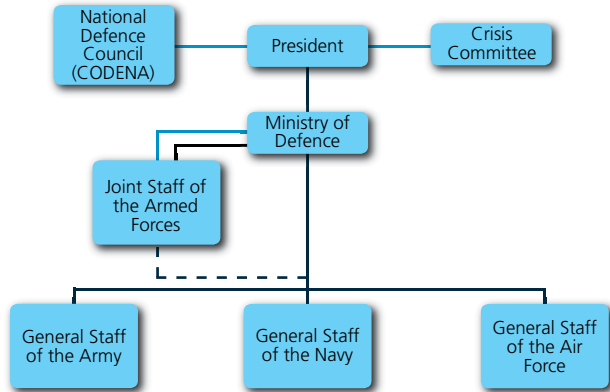

The President may receive assistance and advice from the National Defence Council, an organ that also includes the Vice President, the Ministers, the Secretary of Intelligence and the Chairmen of the parliamentary Defence Committees. The Minister of Defence is in charge of the direction, organization and coordination of national defence activities. The Minister receives the advice of the Joint Staff, responsible for the joint military doctrine, planning and training. Congress enjoys the powers granted by the Constitution and is permanently monitoring the issues related to defence through the Defence Committees in both Houses.

**Source:** Compilation based on *Ley de Defensa Nacional* (N° 23.554 - 1998/05/05) and *Reglamentación de la Ley de Defensa Nacional* (Decree N° 727/2006 - 2006/06/13)

## The Budget

Year	Defence Budget (in US\$)	Government Budget (in US\$)	GDP (in US\$)
2006	1,952,165,821	31,549,633,439	187,035,000,000
2007	2,120,829,805	39,004,202,398	248,332,000,000
2008	2,628,157,098	50,781,906,344	323,800,000,000
2009	2,849,654,256	61,143,165,088	301,331,000,000
2010	3,138,200,705	66,779,810,249	344,143,000,000

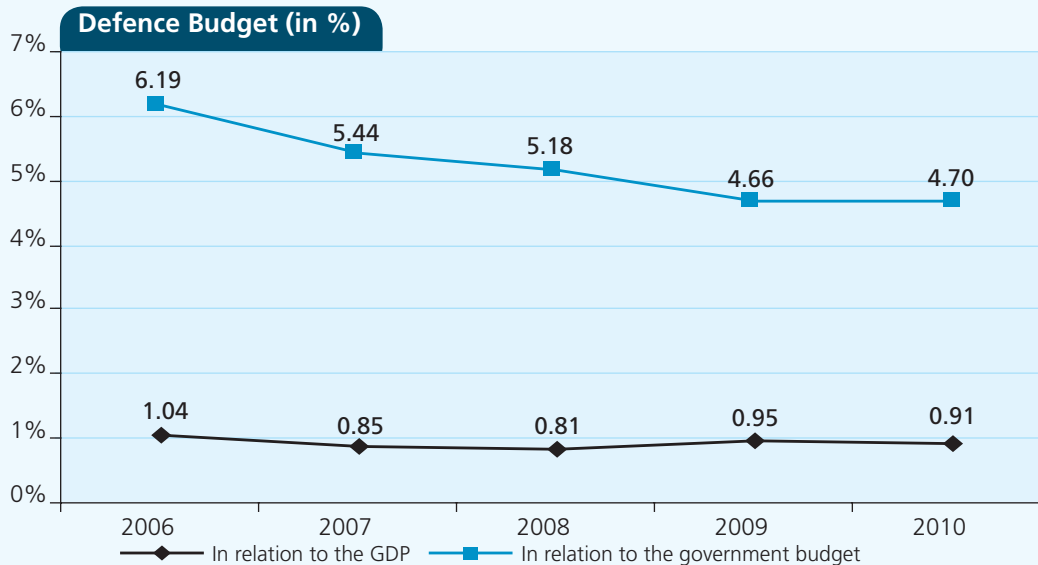

**Defence Budget Breakdown**

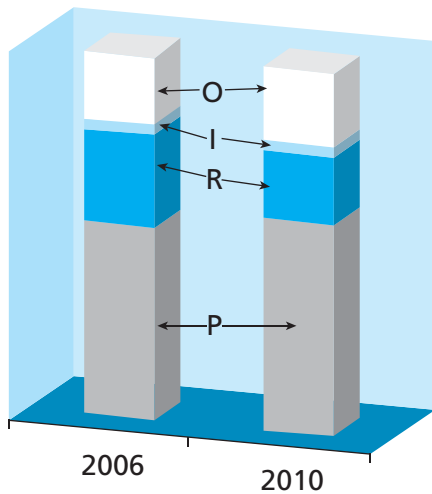

P: Salaries and other benefits  
R: Retirement and pension funds / I: Investment  
O: Other expenses

**Comparative Increase (% variation 2006-2010)**

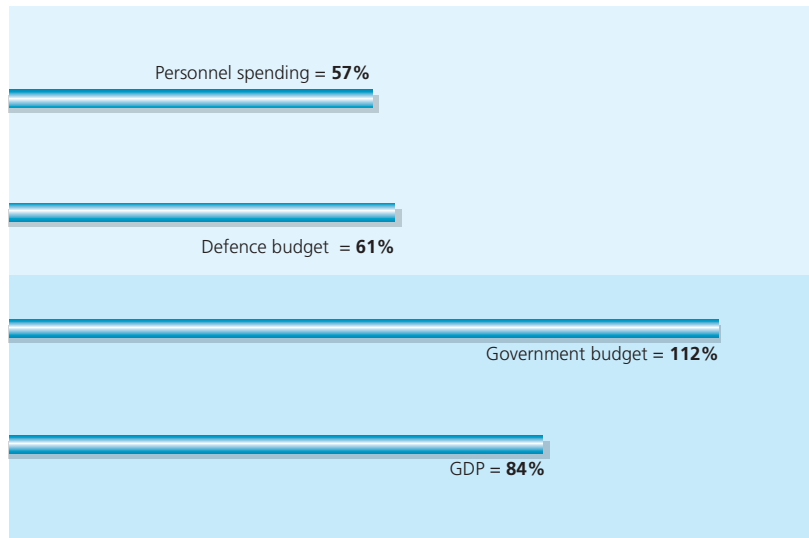

**Defence Budget 2010 (in Local Currency)**

Jurisdictions and Entities	Personnel Expenses	Consumer Goods and Non-personal Services	Fixed Assets	Others *	TOTAL
<b>Ministry of Defence</b>					
Ministry of Defence	117,246,827	300,877,225	343,990,181	8,754,611	770,868,844
General Staff of the Army	3,476,517,997	655,920,418	43,372,190	758,000	4,176,568,605
General Staff of the Navy	1,927,845,492	542,605,484	113,719,000	834,000	2,585,003,976
General Staff of the Air Force	1,603,541,724	536,742,554	120,193,464	548,000	2,261,025,742
Joint Staff of the Armed Forces	20,178,000	222,233,609	82,095,099	84,000	324,590,708
Military Geographic Institute **	20,362,000	25,742,000	4,065,000	165,000	50,334,000
National Weather Service **	44,484,008	25,828,000	2,246,000	2,134,000	74,692,008
Institute for the Financial Support to the Payment of Military Retirements and Pensions (IAFPRPM)***	17,225,000	2,958,000	420,000	2,341,826,000	2,362,429,000
<b>General Department of Military Manufacturing</b>	109,023,000	90,064,000	30,641,000	0	229,728,000
<b>TOTAL</b>	<b>7,336,424,048</b>	<b>2,402,971,290</b>	<b>740,741,934</b>	<b>2,355,103,611</b>	<b>12,835,240,883</b>

\* Includes transfers, financial assets, figurative expenses, debt service, and decrease of other liabilities.  
\*\* Decentralized organization.  
\*\*\* Social security organization.

**Composition of Defence Budget 2010**

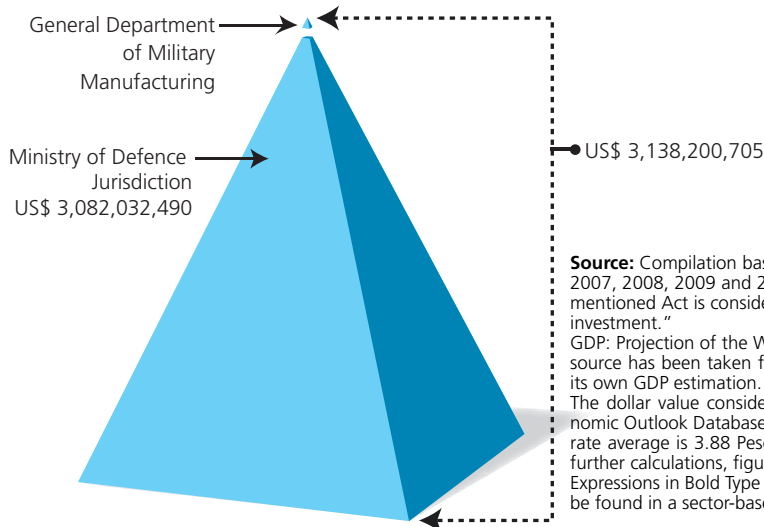

For 2009 and 2010, the Ministry of Defence received, in accordance to the budget, US\$ 197,907,696 for expenses in security and military equipment. This amount accounts for 3.31% of the budget allocation for that period.

**Source:** Compilation based on *Ley de presupuesto general de la administración nacional* 2006, 2007, 2008, 2009 and 2010. The State Budget passed by the Congress by means of the above mentioned Act is considered herein. The concept of investment is that expressed in "Real direct investment."  
GDP: Projection of the World Economic Outlook Database, IMF, of each year under review. This source has been taken for comparative purposes. Each country prepares the budget based on its own GDP estimation.  
The dollar value considered corresponds to the exchange rate determined by the World Economic Outlook Database, IMF, for each year under consideration. As of July, the 2010 exchange rate average is 3.88 Pesos, based on the data provided by the Central Bank of Argentina. For further calculations, figures are provided in local currency.  
Expressions in Bold Type (Table) make reference to the various defence budget items, which can be found in a sector-based or institutional classification of the Budget Act.



**The Ministry of Defence**

**Responsibility:**

The Ministry of Defence exercises the direction, organization and coordination of the activities that are proper to national defence and are not exclusively or directly conducted by the President or assigned to other officials, bodies or organizations. (Ley de Defensa Nacional, N° 23.554 – 1988/05/05, Sec. 11)

**Organization Chart and Personnel**

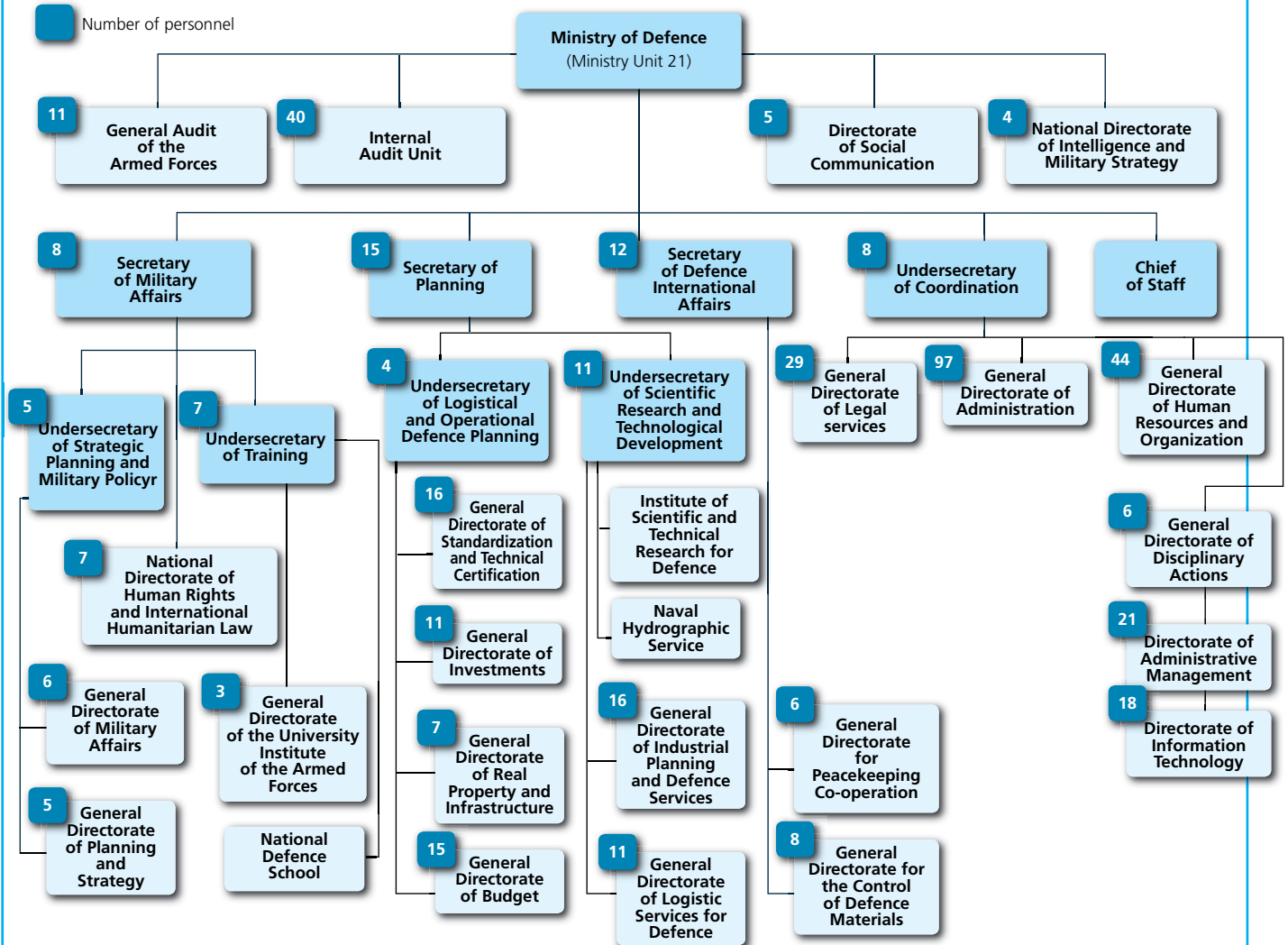

**Note:** The number of personnel refers to the permanent staff, with a total amount of 477 employees. The General Directorate of Legal Services has the Offices of Judicial Matters and Legal Matters, and the Department of Juridical Information under its charge; the General Directorate of Administration has the Directorate of Accounting Budget Management, the General Services and Contracts Directorate and the Treasury Department under its responsibility; and the General Directorate of Human Resources and Organization is responsible for the Offices of Human Resources Policy and Personnel Administration.

<b>Date of Foundation:</b> 1958
<b>Current Minister:</b> (September 2010) Nilda Garré
<b>Can military members be Ministers of Defence?:</b> Yes
<b>Number of military members who were Ministers of Defence:</b> 4
<b>Number of civilians who were Ministers of Defence:</b> 33
<b>Have there been any women in charge of the Ministry of Defence?:</b> Yes (The current Minister of Defence performed functions as Minister in the former administration)
<b>Average permanence in the Minister of Defence position:</b> 1 year and 3 months

[The Minister currently in charge is not considered. The creation date is related to the moment in which the term "Defence" becomes part of the Institution's name]

**Source:** Compilation based on information provided by the Ministry of Defence.

Political Definitions

Policy Guidelines

The notions, positioning and strategic posture embedded in the Nation's Defence Policy are based on the concept of "legitimate defence" as the essential principle around which the entire Argentine defence system is organized. The defence system must converge to repel any military external aggression through the use of the Armed Forces, the military instrument of national defence, in order to guarantee and safeguard the sovereignty, independence and self-determination of the Nation, its territorial integrity and the life and freedom of its people. The Argentine posture also recognizes the importance of inter-agency cooperation as well as the multilateral dimension of defence and security, as genuine supplementary instruments of the defence policy. It conceives defence in its two-fold dimension: the "individual" dimension and the "cooperative" one.

Directives

- Continue and enhance the process of strengthening and consolidating total and effective political governance of national defence (including the consolidation of the institutional architecture designed to that end).
- Advance in the process of building and implementing an integrated logistic system. Strengthen the budget planning capability.
- Further enhance the process of strengthening the defence production industry.
- Develop a fully coordinated and functional defence scientific and technological system.
- Continue the process of defining education policies, as well as the education, training and advanced course structures for the Armed Forces, including curriculum development.
- Develop and strengthen, through the National Defence College, the education and training of the necessary personnel.
- Continue to promote the policy that can, in an integrated and horizontal manner, ensure a human rights perspective. Particularly:
  - a) Collaboration and coordination with the process of memory, truth and justice with respect to the State terrorism process.
  - b) Promotion of an institutional culture of respect of human rights, especially considering the gender factor.
  - c) Deepen the review of statutes, regulations and/or institutional practices.
  - d) Continue the process of overall reform and modernization of the military justice system.
  - e) Develop and optimize the implementation of mechanisms for claim filing and response to cases of abuse of authority, discrimination and other forms of violation of rights in the Armed Forces.
- Give continuity to the gender policies and promote equity conditions and equal opportunities for men and women.
- The organization and operation of the defence system must be mainly organized around its main mission. Subsidiary missions shall not result in changes to the organization and operation. As priority, the focus shall be placed on the country's involvement in peacekeeping operations under the UN or other international organizations. Likewise, priority shall be given to the creation and further enhancement of the Argentina-Chilean Binational Peace Force "Cruz del Sur".
- Provide for and consider the Antarctica as a "scenario" in the framework of which the military instrument is responsible for the provision of logistic support.
- Military Strategic Planning and the force design resulting from it shall be elaborated in accordance with the "capability-based" criterion.
- The organizational and functional design, makeup and characteristics of armed forces' territorial deployment, considered as specific organizations, must strictly serve:
  - I) The missions and competences assigned to them by the legal and regulatory framework in effect.
  - II) The military strategic planning guidelines.
  - III) The reduction of administrative and bureaucratic structures and elimination of organizational entities with no practical purpose.
  - IV) The criterion of "concentration-dispersion" aimed at optimizing resources and logistic support.
  - V) The efficient and rational use of facilities.
  - VI) The joint nature of the military defence system.
- Enhance and strengthen jointness and, particularly, the structure and operation of the Operational Command and specific operational levels and/or entities provided for in the military planning.

Source: *Directiva de Política de Defensa Nacional*, 2009.

Argentina published the *Libro Blanco de la Defensa Nacional (White Paper on National Defence)* in 1999 and the *Revisión de la Defensa (Defence Review)* in 2001.\*

\*At the time of writing, Argentina was in the process of elaborating its *Libro Blanco de la Defensa 2010 (2010 Defence White Paper)*.

Reports Submitted to the United Nations and the OAS

1997	1998	1999	2000	2001	2002	2003	2004	2005	2006	2007	2008	2009
✘	✘	✘	✘	✘	✘	✘	✘	✘	✘	✘	✘	✘
◊	◊		◊		◊			◊	◊	◊	◊	◊
☛				☛				☛	☛	☛		☛

Register of Conventional Arms: ✘ Register of Military Expenditures: ◊ Implementation of Confidence and Security Building Measures: ☛

Source: Compilation based on reports submitted to the United Nations Register of Conventional Arms and the United Nations Instrument for Reporting Military Expenditures and reports submitted to the OAS on the Implementation of Confidence and Security-Building Measures.



**Military Career**

**Commissioned Officers' Career Path <sup>1</sup>**

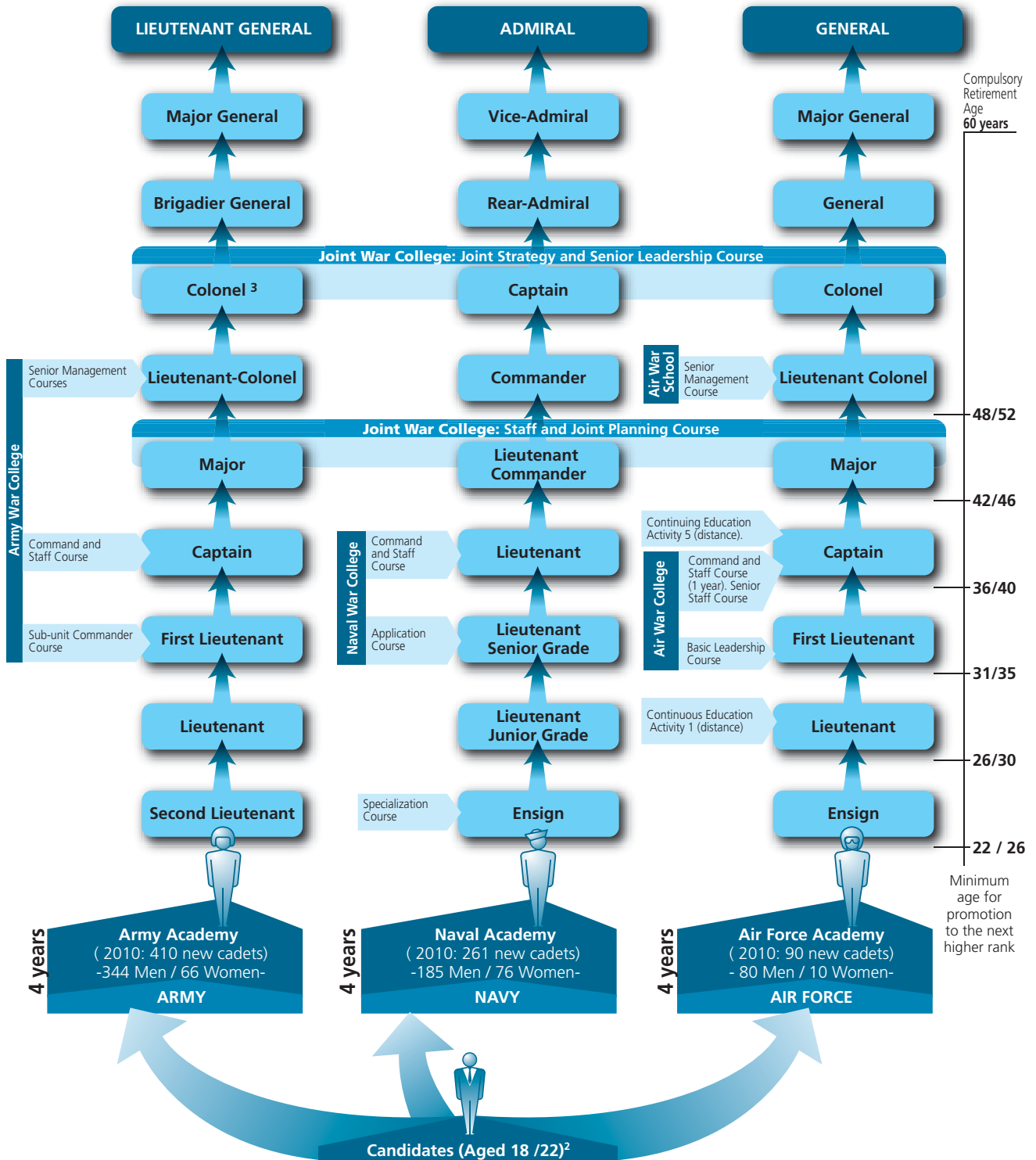

1 Line corps includes officers who have been educated at military academies from the beginning of their professional careers. Further requirements for promotion have not been considered.  
 2 The age of 18-22 has been considered for comparative purposes. Entry age varies depending on the Service: in the Army, 18-25, in the Navy it is 18-22 and in the Air Force, 16-22. The minimum age for promotion shall depend on age of graduation from the military institution.  
 3 The rank of Colonel Major bears and honorific character.

**Source:** Compilation based on *Ley de reestructuración de las Fuerzas Armadas* (N° 24.948 – 1998/04/08). New cadets: Information provided by the Ministry of Defence.

**The Armed Forces**

**General Mission**

The Armed Forces, military instrument of the national defence, will be used in case of external aggressions by the Armed Forces of other State/s, without prejudice to Act N° 24.059 of Internal Security and the Armed Forces Reorganization Act N° 24.948 regarding scenarios foreseen for the use of the military instrument, and the regulations defining the scope of such intervention in support to the internal security operations.  
 (Reglamentación de la Ley de Defensa Nacional N° 23.554, Decree N° 727/2006 - 2006/06/13, Sec. 1)  
 Their primary mission is to repel all external state military aggressions to continually guarantee and protect the sovereignty, independence and self-determination of the Nation, its territorial integrity and the life and freedom of its inhabitants.  
 Their secondary missions involve participating in multinational operations within the framework of the United Nations; participating in internal security missions, in accordance with Internal Security Act N° 24.059; support the national community and friendly countries; while participating in the construction of a subregional defence system.  
 (Directiva de Organización y Funcionamiento de las Fuerzas Armadas, Decree N° 1691/2006 - 2006/11/22)

**Specific Missions**

**Army**

The Argentine Army shall serve the Motherland to contribute to national defence in order to protect its vital interests: the country's independence and sovereignty, self-determination, territorial integrity; natural resources, protection of assets, life and freedom of its inhabitants. Likewise, it shall also contribute to maintaining the representative, republican and federal system of government.

**Navy**

Primary mission: to prepare, train and sustain the Nation's naval power means, in order to contribute to their effective employment within the framework of the joint military planning, thus contributing to the effective fulfilment of the missions assigned to the national defence's military instrument.  
 Complementary missions: involvement in peace operations and/or multinational coalitions under the command of international organizations; maritime and fluvial tasks and of naval security; maritime search and rescue; support to activities carried out in Antarctica; humanitarian assistance; community support; contribution to the preservation of the environment; participation in the development of military cooperation measures, confidence building measures in the regional and international regional framework to prevent situations of conflict; and participation in internal security operations in accordance with Act N° 24.059.

**Air Force**

Contribute to national defence acting effectively and in a deterrent manner in the air space, to continually guarantee and protect the vital interests of the Nation.

**Total Strength: 77,660**

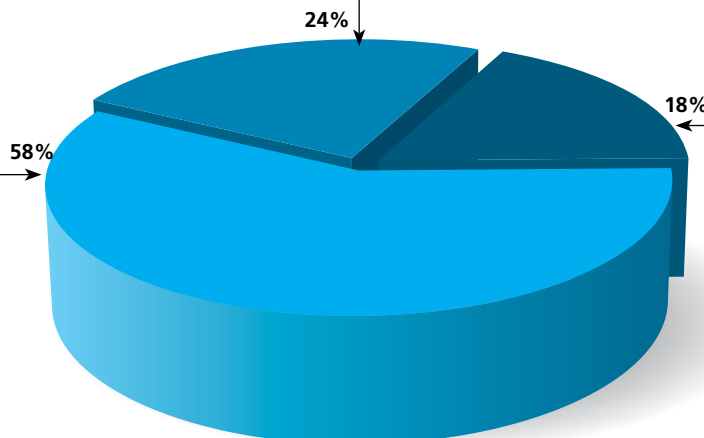
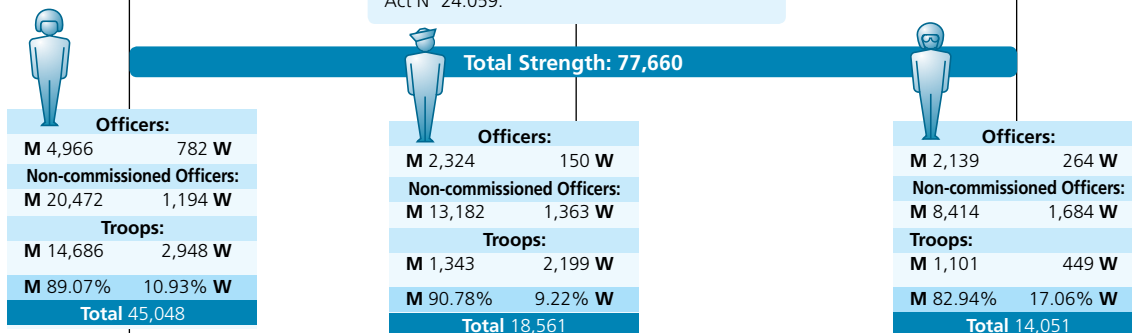

M: Men / W: Women

Source: Websites of the Armed Forces (missions) and information provided by the Ministry of Defence (Regular Forces).





**Women in the Armed Forces**

**Women's Admission to the Armed Forces (year)**

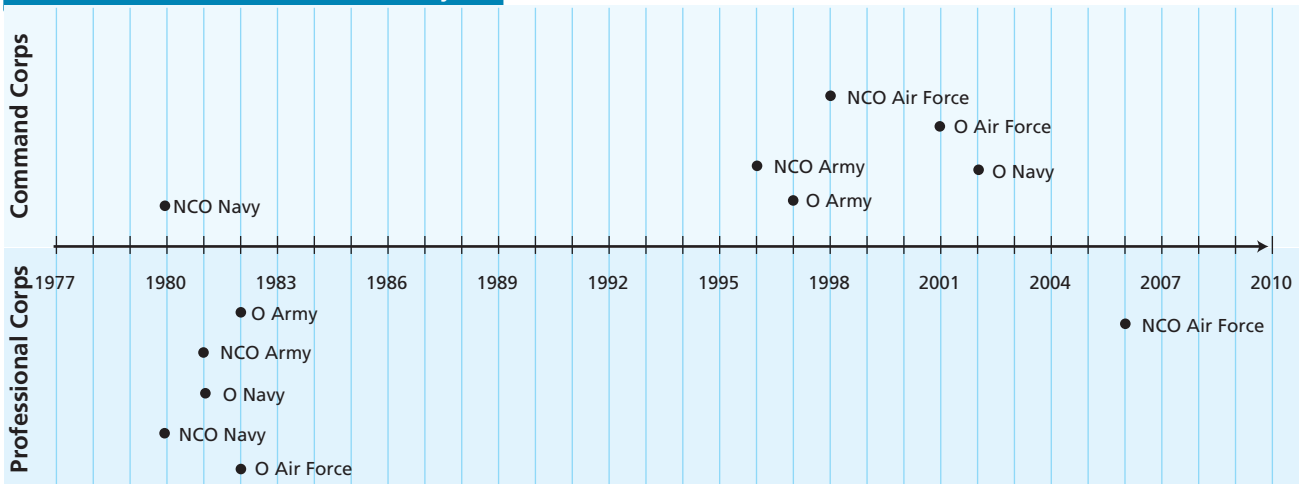

O: Officers - NCO: Non-commissioned Officers

**Note:** The Command corps includes officers who have been educated at military academies from the beginning of their professional careers. The Professional corps refers to those who develop a career in the civilian sphere and are then incorporated to the armed forces.

**Women Officers who have reached the highest rank in the Command Corps (2010)**

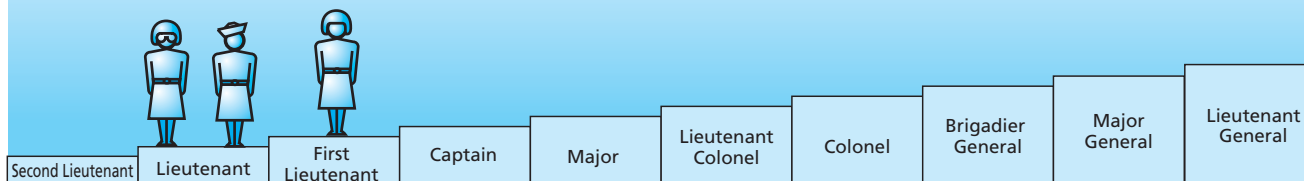

**Note:** These ranks correspond to the Army, as an example. The equivalent ranks for lieutenant are Lieutenant Junior Grade (Navy) and Lieutenant (Air Force). In the naval force, there is one Lieutenant Senior Grade woman serving under a specific time duty regime IDP.

**11.63% (9,033) of the total Armed Forces are women.**

**Source:** Information provided by the Ministry of Defence, and Project 07-184 Global Peace and Security Fund-RESDAL.

**Military Service**

The Military Service is voluntary and is open to all the citizens (men and women) that meet the requirements. The Voluntary Military Service has a two-year duration.

**Army – Applicants and Enlisted per Region (2009)**

Region	Applicants		Enlisted		% of Applicants enlisted
	Men	Women	Men	Women	
Buenos Aires	830	152	377	64	44.91%
Metropolitan Area	749	426	924	187	94.55%
Entre Ríos	517	175	438	46	69.94%
Salta – Jujuy – La Rioja – Tucumán	907	176	327	27	32.69%
Neuquén – Rio Negro	585	259	363	79	52.37%
Mendoza – San Luis – San Juan	1,053	317	375	70	32.48%
Chubut	140	80	231	40	123.18%
La Pampa	453	147	338	19	59.50%
Santa Cruz	106	40	673	47	493.15%
Formosa – Chaco – Corrientes – Misiones – Santa Fe	3,447	834	627	55	15.93%
Córdoba – Santiago del Estero	251	105	603	114	201.40%
<b>TOTAL</b>	<b>9,038</b>	<b>2,711</b>	<b>5,276</b>	<b>748</b>	<b>51.27%</b>

Navy – Enlistment (2009 - 2010)	
Enlisted	
Men 345 soldiers	Women 99 soldiers
TOTAL: 444 soldiers	

Air Force Applicants and Enlisted	
2009	
Applicants 1,494	Enlisted 10
2010	
Applicants 1,913	Enlisted 207

**Note:** In September 2010 a bill for the creation of a voluntary civic service was being discussed in Congress; through this the State would offer the possibility of completing formal education and receiving training in various skills for a minimum period of one year.

**Source:** Compilation based on information provided by the Ministry of Defence.

## Defence and National and International Community

### Participation in Peace Operations

Current Missions	Military Component			
	MEM		MC	
	Men	Women	Men	Women
MINURSO (Western Sahara)	3	-	-	-
MINUSTAH (Haiti)	-	-	673	36
UNFICYP (Cyprus)	-	-	257	9
UNTSO (Israel and Palestine)	5	-	-	-

The CAECOPAZ, Argentine Joint Training Center for Peacekeeping Operations, was created on June 27, 1995.  
In 2009 it trained 2,289 militaries and civilians.



MEM: Military experts on mission, including military observers, judge advocates and military liaison officers, among others - MC: Military Contingent.

**Source:** Compilation based on documents from the Department of Peacekeeping Operations of the United Nations. Data as of 31 August 2010.

Argentina contributes 983 military troops to the United Nations peacekeeping missions, which represents 12.85% of the total contribution of Latin America.

### Gender Policy

In the area of defence, the gender perspective has gained a relevant significance, and it is considered a necessary part of every comprehensive policy for the promotion of human rights. In recent years, the actions have focused on three main aspects:

- 1) The Argentine participation in peacekeeping operations under the United Nations.
- 2) The development of a national plan for day care centers and responsible parenthood.
- 3) The joint work of the health and personnel areas of the Armed Forces on issues of domestic violence.

• **Gender Offices in the Services:** created under Resolution 719/08, to deal with problems and claims from the military personnel without neglecting the hierarchies, and through procedures that facilitate the prevention of personal and institutional damages responding in time and manner.

• **Observatory of the insertion of women in the military career:** responsible for defining policies that promote equality and ensuring that they lead to the professionalization of the Armed Forces in accordance with the core objectives assigned by the National Government.

#### Observatory - Functions

- **Diagnosis:** production and processing of regulatory, statistical and qualitative information on the insertion of women in the military profession.
- **Intervention:** formulation of guidelines for the design of policies leading to the institutionalization of guarantees for the protection of equal opportunities for women throughout their professional careers.
- **Instance of articulation:** between women in the Armed Forces and the Ministry of Defence.

## Support Actions

### Army

- Argentine Army National Plan for Community Support (PLANACEA), under an agreement with the Ministry of Social Development.
- Solidarity campaign (2009) in the province of Chaco, where an average of 160 tons of food were distributed to 3,800 families on a bi-monthly basis.
- Support to the district of Tartagal, province of Salta, in the area affected by the floods, with 25 vehicles and 115 troops. Treatment of 353,100 litres of water.
- 1,101 troops and 553 material units were engaged in humanitarian assistance tasks from December 2008 to November 2009.
- Plan water + jobs: drilling of 33 wells in the district of La Matanza under an agreement with the company AySA.

### Navy

- Support in the search of missing people.
- Logistic support, food and boarding in community assistance efforts.
- Sponsoring of 258 schools.
- Job insertion program (since 2005) and "Let's Sail Together" Program (from 2003), both for individuals with disabilities.
- March 2009: dengue prevention awareness campaign.
- April 2009: contribution to the cleaning of the Bridges Isles.
- June 2009: assistance in the flu immunization campaign.
- Support to festivities, anniversaries and ceremonies in the provinces of Río Negro, La Pampa and Buenos Aires.

### Air Force

- Flights to provide assistance to the Ministry of Health during the sanitary emergency for the dengue epidemics in the NE and NW of the country (2009, domestic and foreign assignments: Catamarca, Chaco, Asunción del Paraguay).
- Fire control.
- Disaster relief.
- Relocatable hospital that can be transported and set up to provide medical assistance in combat zones, or emergency or disaster areas.

### Institute of Scientific and Technical Research for Defence – CITEDEF

Institute under the Ministry of Defence, devoted to research and development activities in the area, as the only joint institution for the Armed Forces. Executive Order 1451/08 assigns to CITEDEF the primary responsibility for the execution of the research and development plans, programmes and projects under the scientific and technological policies for defence that may be assigned by the Ministry.

**Source:** MOD Annual Report, 2008; *Informe para la Modernización del Sistema Logístico de la Defensa*, Ministry of Defence, 2009; information provided by the Ministry of Defence and websites of the Armed Forces.



Analysis:

## Argentina: An Active Player in the Regional Cooperation Process

**Jaime Garreta**

*Advisor to Argentina's National Senate.*

The consequences of the dictatorial processes that ravaged our region were diverse. Those which occurred in our country after the fall of the dictatorship in 1983 appeared from the very beginning of our recovery of democratic institutions and make up the framework that is needed to understand the process that developed since then to this day.

The burdensome past that the young democracy had to face can be summarized in a deep political, institutional, economic and social crisis that needed to be overcome, with 30,000 disappeared who demanded urgent trial and punishment to the military; strong foreign indebtedness; the defeat suffered by our Armed Forces in the Malvinas war, for which we are still paying a high price; and the need to peremptorily solve the conflicting situation with our sister Republic of Chile (derived from old border disputes escalated due to the Messianic attitudes of General Videla, which left us on the verge of war in 1979.)

In sum, the overall result was a weakened, impoverished, isolated and internationally punished Argentina, with a clear confrontation of the society and its political leaders against the armed forces, which in turn made it urgent for civilians to first of all regain political control over the military and security forces.

In order to guarantee this critical aspect of conduct for the democracy, political leaders devoted them-

selves to the task of producing a new legal framework by enacting two key laws: the Defence Act and Internal Security Act. The former established the purpose of the defence system, as well as its civil control, its new chain of command, its structure, the Forces' organization, the national defence service, the territorial organization of defence and their mobilization in case of war. As for the role of the armed forces, this law explicitly excludes them from participating in internal security tasks. The latter regulated the missions and functions of the security forces of the Nation.

Almost a decade later, the National Congress was able to enact the regulatory framework through a law governing the national intelligence system, clearly establishing its functions and missions, and dividing it into two well-defined and ample fields, defence intelligence and internal intelligence, with iron-handed control by the Congress over these activities.

Only once all this was achieved, was the Argentine State able to concentrate in advancing in two areas: development, and the country's reinsertion into the international context. Many conceptual changes were to be introduced in these areas. As for international politics, a new approach had to be defined for the way in which the democratic State was to interact with our nation's closest neighbours, as well as with the rest of the international community.

These conceptual changes, in turn, made it necessary to redefine security and defence policies as well, that needed to go hand in hand with the modifications that neighbouring countries were introducing in their government structures and policies. This allowed the signing by Alfonsín and Sarney, on November 30, 1985, of the *Foz Iguazu* Declaration, the founding stone of MERCOSUR. This was the genesis of the confluence concept and process between Brazil and Argentina, joined later on by Paraguay and Uruguay. This integration idea not only disrupts our countries' economic and commercial relations, but also has impacts on security and defence, with the result that, in these particular fields, we went from the strategic concept of balance of forces for confrontation, to cooperation for sub regional integration. This allowed eliminating from the leadership's mind, simultaneously, the scenario of crossed war between neighbouring countries, as the main support of the security and defence concept in our countries, and at the same time, in terms of interstate alliances, replacing the “*domino*” strategy, which instituted the enemies of our enemies as main strategic allies, and vice versa.

This new cooperation and integration environment had an impact outside the MERCOSUR as well, an example of which is the relationship with Chile. Following the signing of the Treaty of Peace and Friendship between both countries, under which this relation has been nurtured for more than twenty five years, among other things, a final solution has been found to all border disputes dating back to the Independence period. Another example is the sustained mutual defence cooperation policy, covering from confidence building measures to the advancement in the joint comparative study of defence spending, and finally to the development of a binational interoperable force for future peacekeeping operations.

This regional integration process has enabled Argentina not only to place greater emphasis on the resolution of critical issues, such as achieving growth coupled with a more equitable distribution of wealth, but also to gradually emerge from its state of international isolation and become a central actor in the construction of the Southern Cone as a peace and cooperation area.

This MERCOSUR integration process, combined with other processes already underway in the region, and the political will of all twelve South American countries, enabled the signing on May 23, 2008, of a treaty that resulted in the creation of the South American Defence Council (UNASUR), the main objective of which is summarized in the following paragraph of its constitutive treaty: “Their determination to build a South American

identity and citizenry, and develop a regional space integrated in political, economic, social, cultural, environmental, and infrastructure terms, so as to contribute to the strengthening of the union of South America and the Caribbean.”<sup>1</sup> The unanimous appointment of former Argentine President Néstor Kirchner as Secretary-General of UNASUR marked the growing commitment and importance that our country had gained in this South American integration process.

In this context, the South American Defence Council of UNASUR was created in Santiago de Chile, on December 11th, 2008, as a consultation, cooperation and coordination body focused on defence matters. Within this framework, the “*Center for Strategic Defence Studies of the South American Defence Council (CEED-CDS)*” was set up for the generation of knowledge and dissemination of a South American strategic defence and security vision, to be seated in the city of Buenos Aires. As for this Center, Argentina will have an extensive role to fulfill, comprising not only the proposal of candidates to the Director's office, but also being responsible for the financing of its operating structure, maintenance and recruitment of technical, administrative, and professional staff, as well as ensuring an equitable participation of experts from the different member countries, until the entry into force of UNASUR's Constitutive Treaty.

In sum, the process that commenced with MERCOSUR, and is now strengthened with the creation of UNASUR, has been steadily transforming South American geography in an area where not only the concept of peace and cooperation is being enforced, but also where progress is being made in developing a new community identity, respectful of diversity amongst our peoples. In this process, Argentina has been playing an active role also in relation to the institutions that represent our citizenries, such as parliaments. In the case of MERCOSUR, it was strengthened through the creation of PARLASUR, a parliament operating since 2007 with its own Defence Committee dedicated to the promotion of community regulations. Furthermore, efforts are being made towards the completion of the UNASUR's Parliament, in accordance with the provisions of its constitutive treaty. Strategic debate must be incorporated into this process of building the new regional parliament, so that from its very inception, the concept is loud and clear, of the kind of security we all wish to establish in our regional community space.

1 Unión de Naciones Suramericanas, *Tratado Constitutivo de la Unión de Naciones Suramericanas*, (Brasilia: UNASUR, may 23 2008), Preamble.



# Bolivia

## The Legal Framework and the Defence System

### National Legislation

#### Systems and Concepts

- Organic Law of the Armed Forces (N° 1.405 - 1992/12/30)
- Organization of the Executive Power Act (N° 2.446 - 2003/03/19)

#### Military Organization

- Decree-Law on the Military Social Insurance Corporation (N° 11.901 - 1974/10/21. Last amendment: Law N° 1.732- 1996/11/29)
- Decree-Law of Organization of Military Justice (N° 13.321 - 1976/04/02)
- Manual on the Use of Force in case of Internal Conflict (Supreme Decree N° 27.977 - 2005/01/14)

**Source:** Compilation based on the legislation above mentioned. For constitutional provisions see Chapter 1.

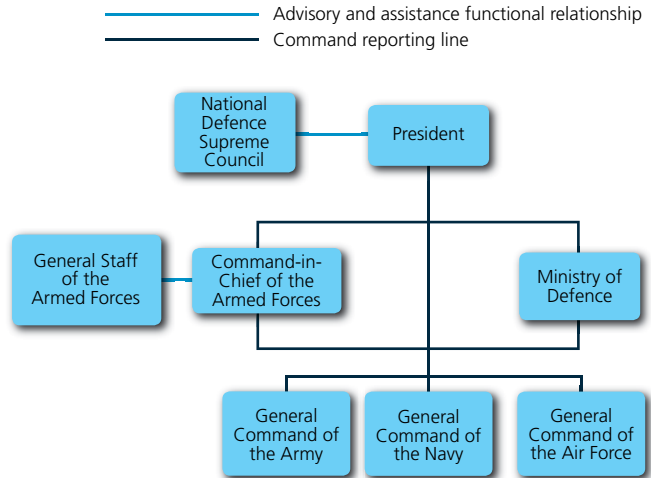

The Military High Command is the highest decision-making organ of the Armed Forces. It is composed of the President, the Minister of Defence, the Commander-in-Chief, the Chairman of the Joint Chiefs of Staff, and the General Commanders of the Armed Forces. They form the Supreme Council of National Defence, the highest advisory body. The President issues the orders to the Armed Forces through the Minister of Defence in political and administrative matters, and through the Commander-in-Chief in technical and operational matters. The Commander-in-Chief receives the advice of the General Staff. The Congress holds the powers granted by the Constitution and permanently monitors defence related issues through the specific committees in both Houses.

**Source:** Compilation based on *Ley orgánica de las Fuerzas Armadas* (N° 1.405 - 1992/12/30).

## The Budget

Year	Defence Budget (in US\$)	Government Budget (in US\$)	GDP (in US\$)
2006	197,291,177	6,220,975,988	10,207,000,000
2007	193,405,756	7,401,725,343	12,710,000,000
2008	254,520,509	11,203,635,538	16,699,000,000
2009	307,478,493	14,797,415,012	17,549,000,000
2010	336,894,359	15,202,917,715	19,086,000,000

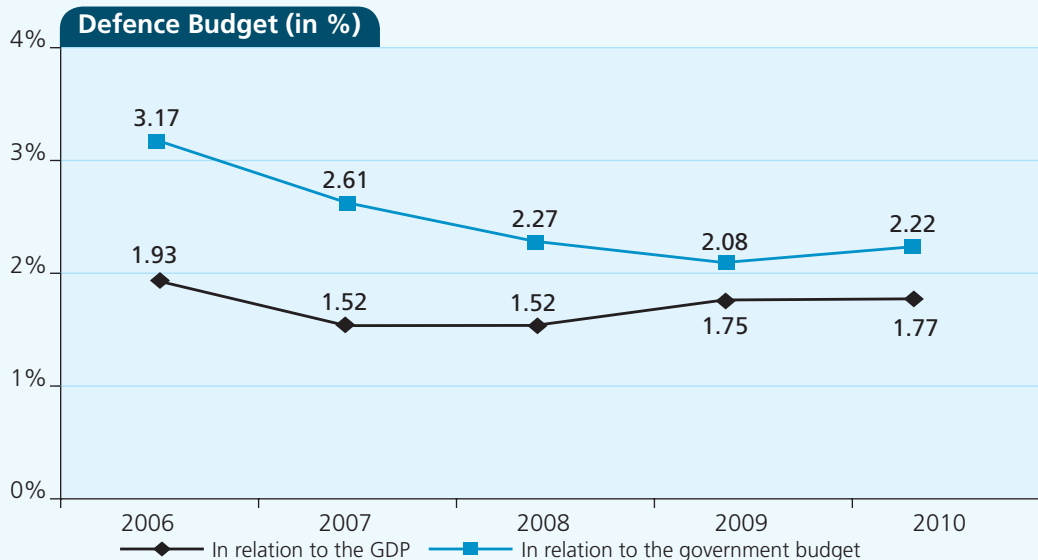

**Defence Budget Breakdown**

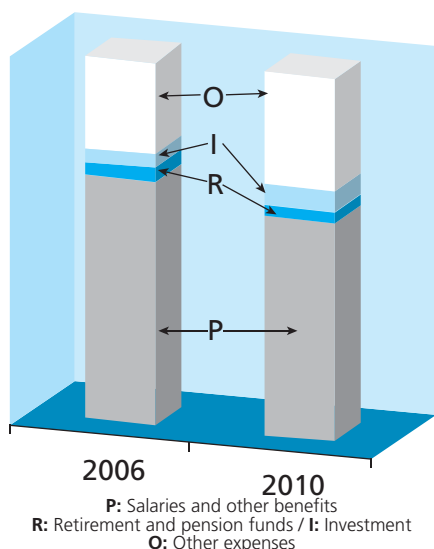

**Comparative Increase (% variation 2006-2010)**

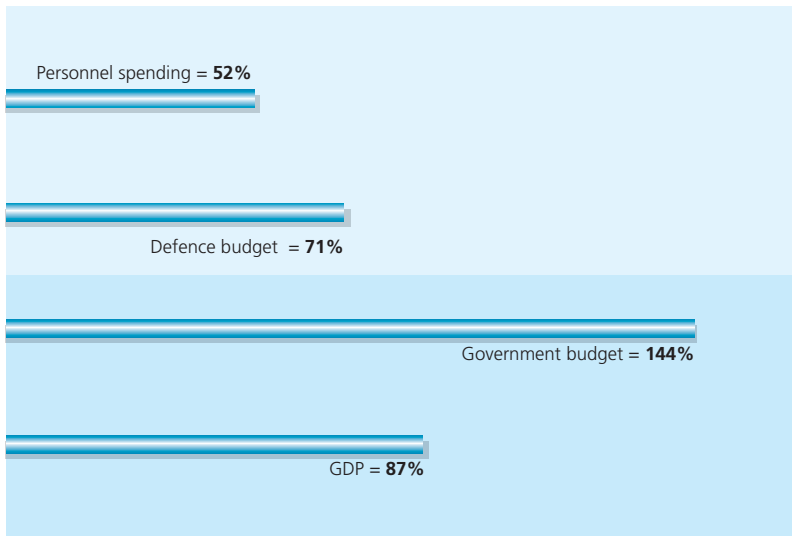

**Defence Budget 2010 (in Local Currency)**

Institutions	Personnel Services	Non Personnel Services	Materials and Supplies	Others*	TOTAL
<b>Ministry of Defence</b>	1,324,422,442	135,560,128	147,027,515	295,312,273	1,902,322,358
Military Social Security Corporation **	56,474,852	30,334,390	33,111,307	108,180,577	228,101,126
Military School of Engineering**	7,046,195	21,737,151	4,394,292	35,096,417	68,274,055
Engineering Command of the Army**	9,277,640	39,334,060	67,372,638	24,036,329	140,020,667
National Naval Hydrography Service**	111,203	1,525,882	541,347	2,030,006	4,208,438
National Aerophotogrametric Service **	256,683	1,229,981	1,622,460	1,094,390	4,203,514
Geodesic Maps Service**	351,048	214,807	79,678	0	645,533
<b>Supreme Council of Plurinational Defence</b>	<b>243,201</b>	<b>39,880</b>	<b>94,911</b>	<b>0</b>	<b>377,992</b>
<b>TOTAL</b>	<b>1,398,183,264</b>	<b>229,976,279</b>	<b>254,244,148</b>	<b>465,749,992</b>	<b>2,348,153,683</b>

\* Includes real assets, financial assets, public debt services, transfers, taxes, royalties, and other expenses. The financial assets of the Military Social Security Corporation are not taken into consideration.

\*\* Institutions under the responsibility of the Ministry of Defence.

**Composition of Defence Budget 2010**

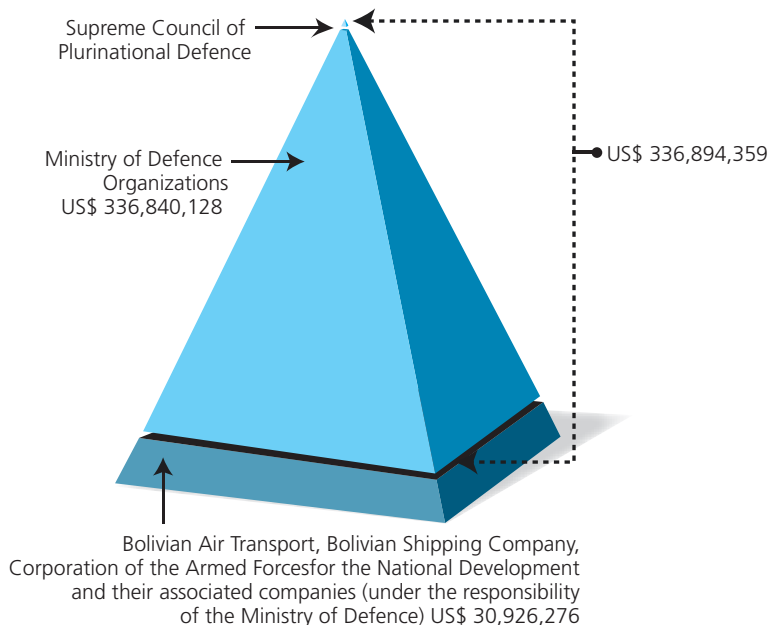

In 2009, a contract was entered into with China for US\$ 57,800,000 for the acquisition of aircraft systems for the Air Force. The payment shall be due in 2012. This amount accounts for 5.3% of the budget allocated to defence in the last four years. Other contracts with the Russian government are under discussion.

**Source:** Compilation based on *Ley del presupuesto general del Estado para el año*. The State Budget passed by the Congress by means of the above mentioned Act is considered herein. The concept of investment is that expressed in "Real assets". Acquisitions: Supreme Decree N° 0310 (2009/09/28).

GDP: Projection of the World Economic Outlook Database, IMF, of each year under review. This source has been taken for comparative purposes. Each country prepares the budget based on its own GDP estimation.

The dollar value considered corresponds to the exchange rate determined by the World Economic Outlook Database, IMF, for each year under consideration. As of July, the 2010 exchange rate average is 7.07 Bolivianos, based on the data provided by the Central Bank of Bolivia. For further calculations, figures are provided in local currency.

Expressions in Bold Type (Table) make reference to the various defence budget items, which can be found in a sector-based or institutional classification of the Budget Act.



**The Ministry of Defence**

**Responsibility:**

The Ministry of Defence is the political and administrative body of the Armed Forces. The Minister of Defence is the legal representative of the armed institution before the public powers.

(Ley orgánica de las Fuerzas Armadas, Nº 1.405 – 1992/12/30, Sec. 22)

**Organization Chart**

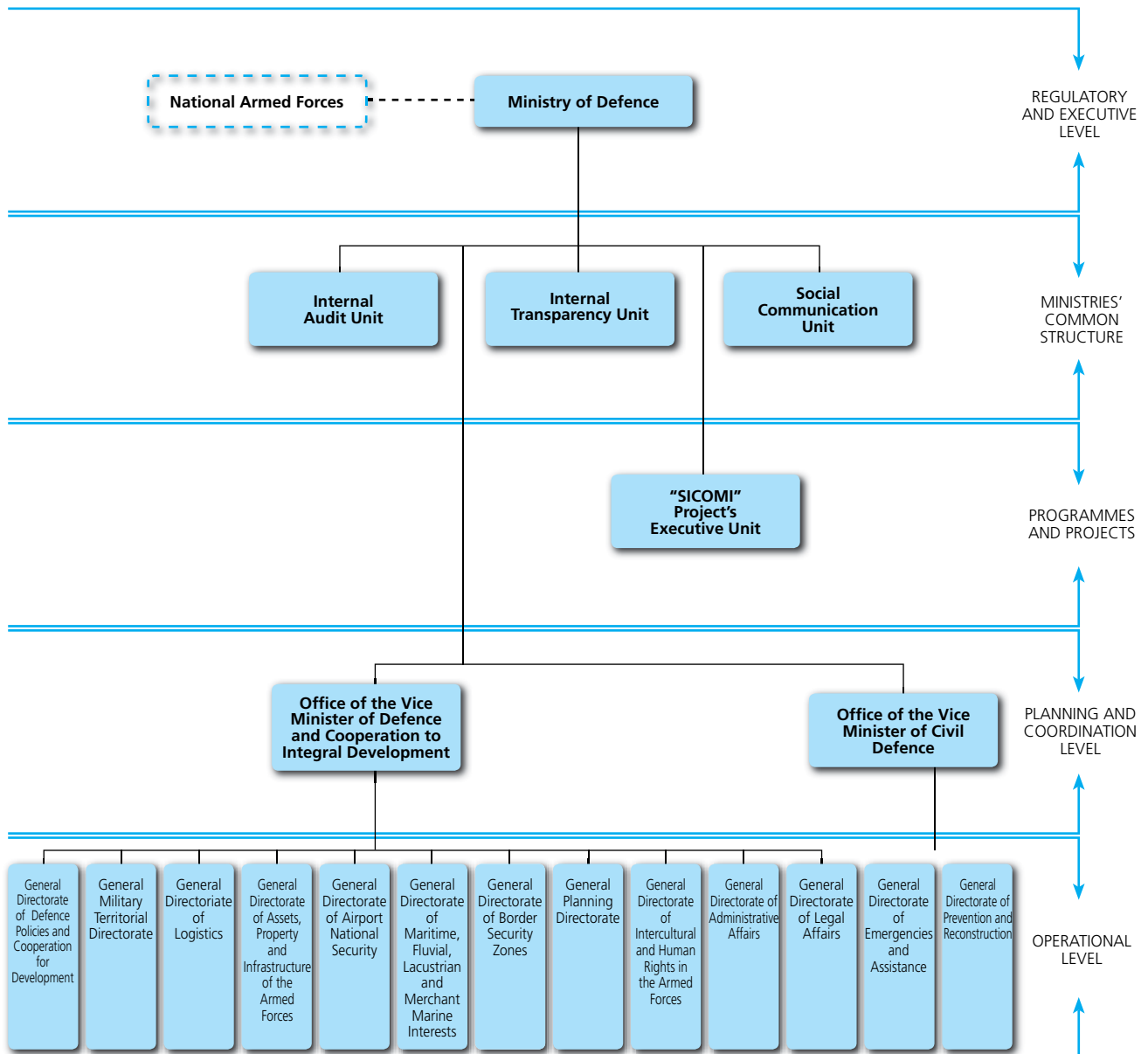

**Date of Foundation:** 1933

**Current Minister (September 2010):** Rubén Aldo Saavedra Soto

**Can military members be Ministers of Defence?:** Yes (if they have retired)

**Number of military members who were Ministers of Defence:** 39

**Number of civilians who were Ministers of Defence:** 37

**Have there been any women in charge of the Ministry of Defence?:** No

**Average permanence in the Minister of Defence position:** 1 year

[The Minister currently in charge is not considered. The creation date is related to the moment in which the term "Defence" becomes part of the Institution's name]

**Source:** Bases para la Discusión de la Doctrina de Seguridad y Defensa del Estado Plurinacional de Bolivia, 2010 and information provided by the Ministry of Defence.

**Political Definitions**

**Policy Guidelines**

**State Objectives**

The State's objectives around defence and security are the set of goals that the State intends to attain, which result from the interpretation of the complex and polysemic concept of "live well", and respond to the doctrine of a Plurinational State and to the New Political Constitution of the State which are needed to streamline and guide the political action of the government.

- Preserve the existence of the State with independence, sovereignty, dignity and the integrity of its possessions.
- Consolidate unity within plurinational diversity.
- Strengthen democracy.
- Expand social justice with inclusion and solidarity.
- Ensure integrated development.
- Preserve the environment and use our resources in harmony with nature.
- Reaffirm and promote international presence of the State.
- Promote sea claims with sovereignty.

The country has a non-common military defence model, not aggressive, creative and dynamic, based on civil-military co-responsibility, allowing the concurrent integration of all actors of society for the defence of the nation. This strategic concept requires giving effective response, balancing the intensity of external and internal threats with the resources available to the State.

This model responds to a bi-dimensional concept, consisting in the use of conventional military force, based on the employment of highly versatile joint units. Considering, on the one hand, a response level proportionate to the intensity of the threat to be faced; on the other hand, in face of a scenario of external threat of asymmetric aggression to our sovereignty or territorial integrity which places us in a situation disproportionate in terms of means, modifying the conventional force structure, avoiding direct confrontation to gain greater freedom of action.

**Purpose of State Defence**

The following purposes are considered for the defence of a Plurinational State:

- Guaranteeing the security of the population to "live well."
- Protecting and preserving cultural diversity.
- Protecting and preserving natural renewable and non renewable resources.
- Maintaining the State's sovereignty and territorial integrity.
- Actively participating to attain high social and economic development.
- Participating in cooperative and collective security.
- Maintaining the non renounceable and imprescriptible claim to recover access to the Pacific Ocean.
- Protecting and preserving biodiversity and the environment.

**Security and Defence Policies:**

- Optimization of the Armed Forces' joint operational structure, building upon their immediate response capability in face of internal or external threat situations.

- Technology modernization and logistics renewal of the Armed Forces, in order to guarantee a reasonable operational capability facilitating compliance with its essential mission and granting it the technical conditions for its effective participation in integrated development.

- Strengthening security and promoting the integrated development in border security areas.

- Promote a culture of respect for human rights and create dignified conditions, with equity, reciprocity and multiculturalism to "live well" in troops quarters.

- Promote the use and peaceful exploitation of the outer space and apply telematic systems allowing the protection of the State's sensitive information.

- Promote the reform of defence area legislation, in consonance with the new precepts in the Constitution, contributing to legal stability and making possible the modernization of the institution.

- Generating a defence culture creating awareness among Bolivian population of their importance for the State's existence and development.

- Becoming the guarantors of democracy and the State's institutional order.

- Strengthen the State's Civil Defence System with the means and the structure of the defence area for the performance of activities associated with emergency response.

- Supporting the State's social protection policy.

- Strengthen defence industries for the purpose of benefiting the State's productive undertakings.

- Promoting the development of science and technology within the Armed Forces in order to contribute to innovation and technological advance within the defence sector and to the integrated development of the State.

- Project military service as an alternative for youth access to technology.

- Defence of the environment and cultural heritage.

- Promote a culture of gender equality and the removal of all forms of discrimination as the axis for human development.

- Sustain our claim to sea access.

- Promote the development of sea, river, lake, and merchant marine interests.

- Strengthen regional military integration for security and defence.

- Actively participate in international initiatives geared to strengthen and maintain regional and world peace.

- Support international initiatives to reduce the production of chemical substances for mass destruction arms.

Bolivia published the *Libro Blanco de la Defensa* (White Book on Defence) in 2004 and *Bases para la Discusión de la Doctrina de Seguridad y Defensa del Estado Plurinacional de Bolivia* (Basis for the Discussion of the Security and Defence Doctrine of the Bolivian Plurinational State) in 2010.

Source: *Bases para la Discusión de la Doctrina de Seguridad y Defensa del Estado Plurinacional de Bolivia*, 2010.

**Reports Submitted to the United Nations and the OAS**

1997	1998	1999	2000	2001	2002	2003	2004	2005	2006	2007	2008	2009
		✘	✘	✘	✘	✘	✘	✘	✘		✘	✘
								◊	◊	◊		

Register of Conventional Arms: ✘ Register of Military Expenditures: ◊ Implementation of Confidence and Security Building Measures: ●

Source: Compilation based on reports submitted to the United Nations Register of Conventional Arms and the United Nations Instrument for Reporting Military Expenditures and reports submitted to the OAS on the Implementation of Confidence and Security-Building Measures.





**Military Career**

**Commissioned Officers' Career Path <sup>1</sup>**

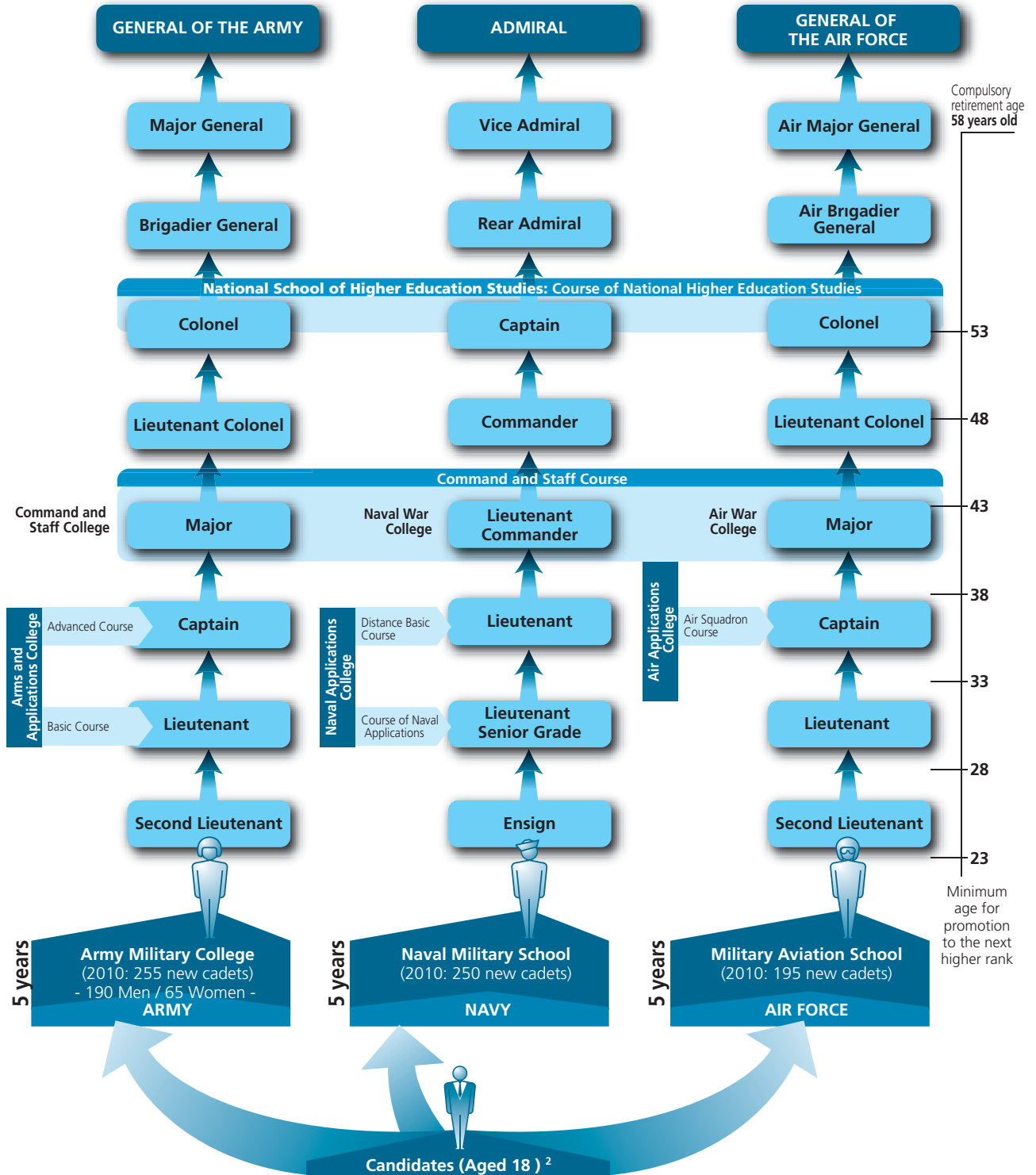

1 Command corps includes officers who have been educated at military academies from the beginning of their professional careers. The graph makes a theoretical reconstruction of officers' promotion through the completion of mandatory courses. Further requirements for promotion have not been considered.

2 The age of 18 has been considered for comparative purposes.

3 Since 2010, all new cadets of Military College of the Army attend complementary studies at the Engineering Military College, the Naval Military School and the Military Aviation School.

**Source:** Compilation based on *Ley orgánica de las Fuerzas Armadas de la Nación* (Nº 1.405 – 1992/12/30). New cadets: Information provided by the Military College, the Naval Military School and the Military Aviation School.

### The Armed Forces

#### General Mission

The Armed Forces have the fundamental mission to defend and maintain national independence, security and stability of the Nation, its national honour and sovereignty; ensure the rule of the Political Constitution, guarantee the stability of the legally established Government and cooperate in the integral development of the country. (Constitution, Sec. 244)

#### Specific Missions

##### Army

- Defend the sovereignty and the integrity of the national territory.
- Guarantee land security and cooperate with maintaining the public order as instructed by the Commander-in-Chief.
- Take part in the integration of the national territory by building and opening roads, motorways and other access ways.
- Occupy, protect and support the development of national borders.
- Protect vital areas and cities of the country.
- Carry out specific missions with the support of the Air Force and/or the Naval Force.
- Actively participate in the integral development of the Nation, according to the guidelines of the Commander-in-Chief.
- Contribute to the empowerment of the country in coordination with other Forces, enhancing, fostering and protecting national development.
- Create and edit geographic and political maps of the national territory.
- Protect the sources of production and legally constituted services, as well as the natural resources and ecological preservation within the national territory.

##### Navy

- Ensure the sovereignty and defence of river, marine and lake interests of the Nation.
- Guarantee free navigation for the Merchant Marine in seas, rivers and lakes controlling the right to use the territorial sea, adjacent areas, continental shelf and seabeds.
- Contribute to the empowerment of the Nation in coordination with the other Services, enhancing, fostering and protecting military, merchant and private shipping.
- Create the national hydrographical maps.
- Prevent and repress acts of piracy in navigation, trade and fishing.
- Carry out specific missions supporting the Army and/or Air Force.
- Actively participate in the integral development of the Nation according to the guidelines issued by the Commander-in-Chief.
- Exercise competence and jurisdiction on patrimonial waters, ports and naval facilities in accordance with the regulations established in the Fluvial, Maritime, and Lake Navigation Act.

##### Air Force

- Ensure the sovereignty and defence of the national air space.
- Reach and maintain a position of supremacy in the air space, enabling the execution of a deterrent action on a given enemy.
- Contribute to the integration of the national territory by means of air transport services.
- Carry out the necessary and timely airlift to support all military operations of national defence.
- Execute specific missions to support the Army and/or Navy.
- Actively participate in the integral development of the Nation, in accordance with the guidelines issued by the Commander-in-Chief.
- Permanently surveil and repress acts of piracy in military and civil air navigation.
- Protect and foster the development of military and civil aviation, infrastructure, aerospace industry and institutes of aerospace scientific research of the Nation.

Total Strength: 39,492

	<b>Officers:</b>
M 2,793	90 W
<b>Non-commissioned Officers:</b>	
M 4,337	55 W
<b>Troops:</b>	
M 21,218	0 W
M 99.49%	0.51% W
<b>Total 28,493</b>	

	<b>Officers:</b>
M 915	0 W
<b>Non-commissioned Officers:</b>	
M 1,549	0 W
<b>Troops:</b>	
M 2,870	0 W
<b>Total 5,334</b>	

	<b>Officers:</b>
M 902	0 W
<b>Non-commissioned Officers:</b>	
M 1,644	81 W
<b>Troops:</b>	
M 3,038	0 W
M 98.57%	% 1.43 W
<b>Total 5,665</b>	

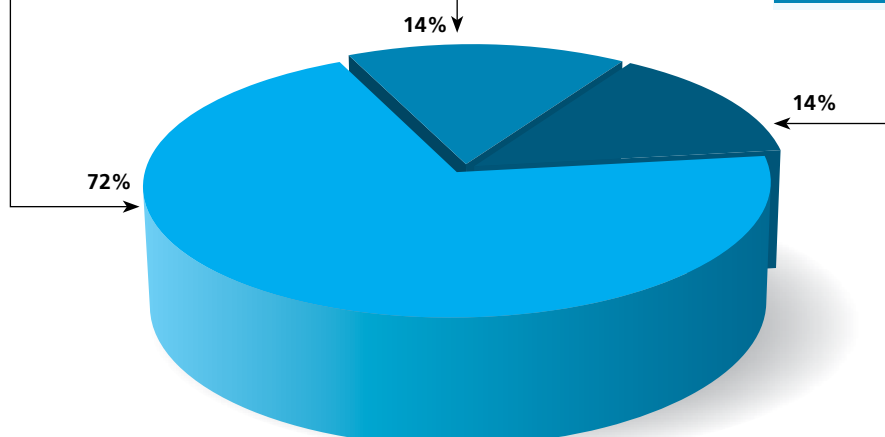

M: Men / W: Women

Source: Ley orgánica de las Fuerzas Armadas (Nº 1.405 - 1992/12/30) (missions) and information provided by the National Army (Regular Forces).



**Women in the Armed Forces**

**Women's Admission to the Armed Forces (year)**

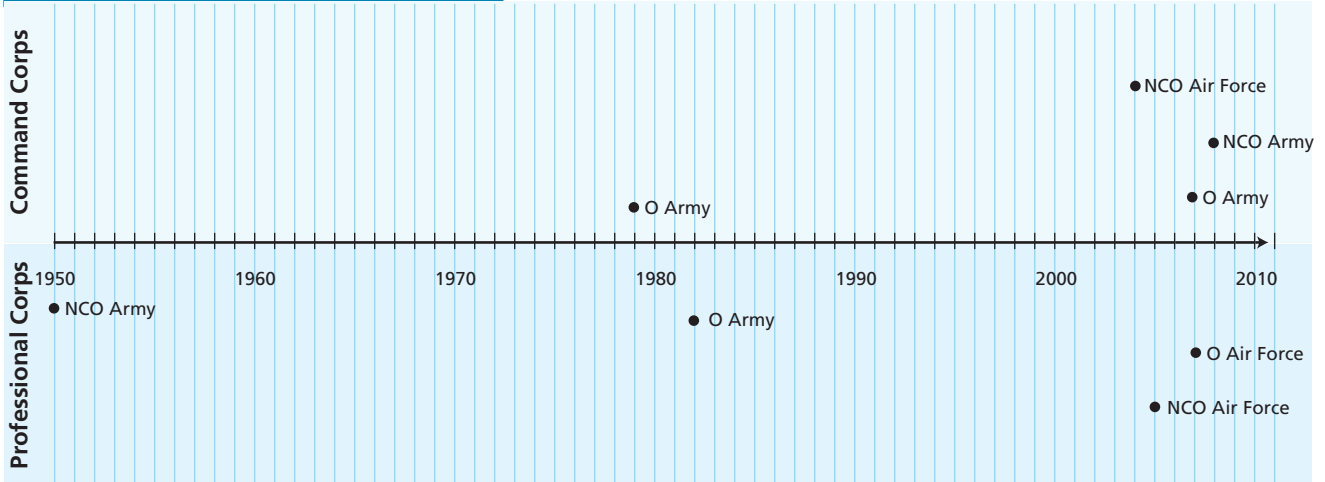

O: Officers - NCO: Non-commissioned Officers

**Note:** In Bolivia, the first women entered the service between 1979 y 1985, later admission re-opened in 2003. Women are not entering the Naval Force, although future officers are trained abroad. The Command corps includes officers who have been educated at military academies from the beginning of their professional careers. The Professional corps refers to those who develop a career in the civilian sphere and are then incorporated to the armed forces.

**Women Officers who have reached the highest rank in the Command Corps (2010)**

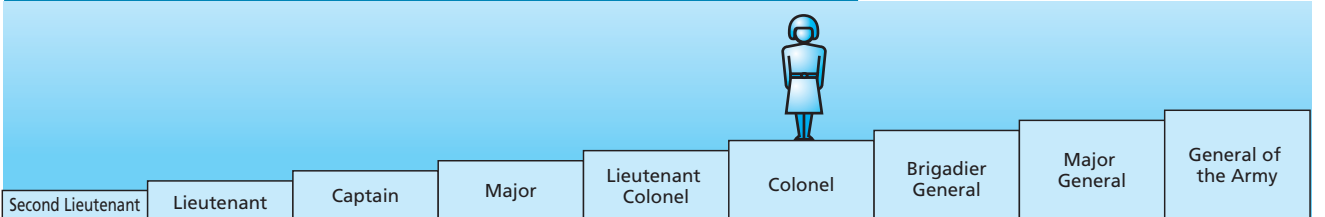

**Note:** These ranks correspond to the Army, as an example. Today's women Colonels are graduates from the Officers School's first cohort. Women officers from the Air Force are in their 4<sup>th</sup> year of instruction.

**0.57 % (226) of the total Armed Forces are women.**

**Source:** Information provided by the Ministry of Defence, and Project 07-184 Global Peace and Security Fund.- RESDAL.

**Military Service**

It is mandatory for all men of the appropriate age to enter the military service as conscripts. Soldiers and sailors are paid a per-diem rate. Currently, the Pre-military Service programme has been re-implemented for men and women in their 3rd and 4th year of high school, to voluntarily provide military service during weekends.

**Regionalized recruitment (in %)\***

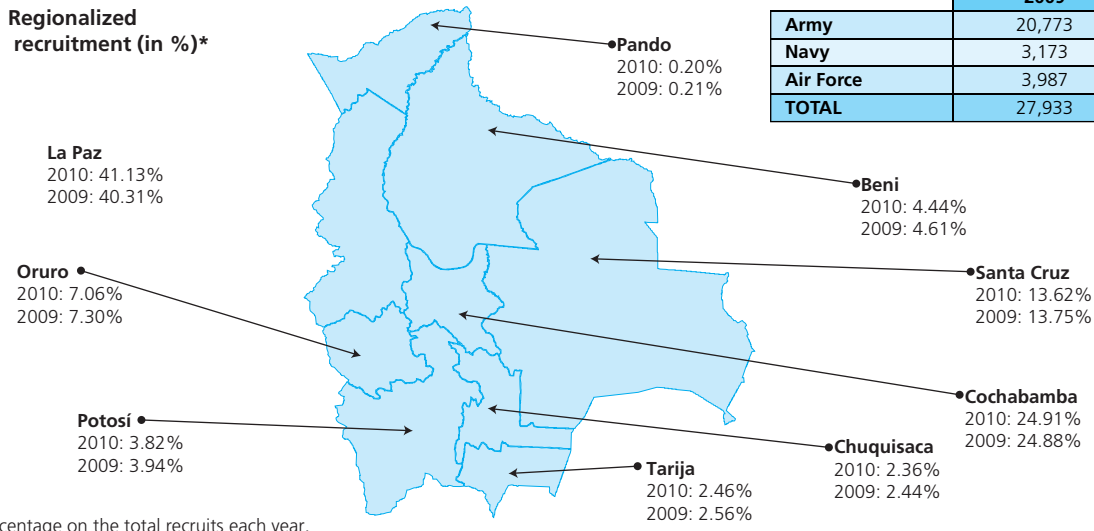

\* Percentage on the total recruits each year.

	Number of recruits	
	2009	2010
<b>Army</b>	20,773	21,218
<b>Navy</b>	3,173	3,803
<b>Air Force</b>	3,987	4,284
<b>TOTAL</b>	27,933	29,305

**Source:** Bases para la Discusión de la Doctrina de Seguridad y Defensa del Estado Plurinacional de Bolivia, 2010 and information provided by the Ministry of Defence.

## Defence and National and International Community

### Participation in Peace Operations

Current Missions	Military Component			
	MEM		MC	
	Men	Women	Men	Women
MINUSTAH (Haiti)	-	-	192	16
MONUSCO (Dem. Rep. of Congo)	10	-	19	-
UNAMID (Darfur)	1	-	1	-
UNMIL (Liberia)	2	-	1	-
UNMIS (Sudan)	14	1	-	-
UNOCI (Ivory Coast)	3	-	-	-

The Centre of Peacekeeping Operations of the Bolivian Army (COMPEBOL), was created on January 23, 2007.

In 2009, 259 force members and civilians were trained on peacekeeping operations.



MEM: Military experts on mission, including military observers, judge advocates and military liaison officers, among others - MC: Military Contingent.

**Source:** Compilation based on documents from the Department of Peacekeeping Operations of the United Nations. Data as of 31 August 2010.

Bolivia contributes 260 military troops to the United Nations peacekeeping missions, which represents 3.40 % of the total contribution of Latin America.

### Equal Opportunities Programme for Indigenous Candidates to the Army's Military Academies

The Government of the Plurinational State has adopted a public policy of social inclusion and equal opportunities for all the Bolivian people, in the different public and academic sectors. Through the Ministry of Defence, the programme is aimed at inclusion of indigenous peoples, who have completed their high school education in rural schools and have no economic funds to enter the men and women cadet instruction programme in the Army's Military School "Cnel. Gualberto Villarreal", or as students of the Army's various military academies. The programme was created to respond to a historical demand, thus opening the doors to sectors previously deprived for these social groups, in a process designed to eliminate discrimination and racism.

Stages of the Program: *First stage:* Official announcement, levelling, selection and admission.

*Second stage:* Military instruction in institutes.

Year of admission into the programme*	Admitted Men / Women	Year of entry in Military School	Students Attending Military School Year – Men / Women
2005	20 / -	2006	5to año- 7 / - cadets
2006	20 / 5	2007	4to año- 10 / 2 cadets
2007	20 / 5	2008	3er año- 13 / 3 cadets
2010	21 / 6	2011	
<b>Total</b>	<b>81 / 16</b>		<b>30 / 5 cadets</b>

\*In 2008 and 2009, no students entered due to the closing of the first years of Armed Forces' institutes. The programme is expected to be extended in 2011 to the Air Force and the Navy.

## Support Actions

### Literacy Programme "YO SI PUEDO" (I CAN)

Pursuant to Supreme Decree No. 28,675, of April 13, 2006, the programme was created with the main purpose of eradicating illiteracy (823,256 illiterate persons in all 9 departments); the Armed Forces made available all necessary human, material and technical resources to effectively support the programme, implementing literacy centres in military premises, participating as facilitators and teachers for illiterate persons, transporting equipment and material with available means to all educational premises, and reaching the national territory's most remote areas.

#### Renta dignidad

Bonus granted to all persons over 60 years old from the Plurinational State, with the purpose of reducing poverty levels and providing for a dignified old age



-The Armed Forces conduct the monthly payment distribution in all 9 departments - comprising 185 centres of payment. In 2009, 89,880 payments were effected.

#### Juancito Pinto

Bonus granted every year to school age boys and girls for school material and clothing, to contribute to increase school completion rates.



-The Armed Forces conduct the annual distribution of this payment, particularly in rural and border areas. In 2009, it was able to reach a student population of 974,120 children.

#### Juana Azurduy

Bonus granted to all pregnant and post-partum women, to help improve mother-child nutritional levels, thus reducing infant mortality rates.



- The Armed Forces grant this bonus across the entire national territory and, particularly, in border areas reaching 207 points of payment and effecting 37,983 payments in 2009.

**Source:** Information provided by the Directorate of Human Rights and Intercultural Affairs of the Ministry of Defence, The National Army, *Bases para la Discusión de la Doctrina de Seguridad y Defensa del Estado Plurinacional de Bolivia*, 2010 and website of the Ministry of Education.



## Analysis:

# Plurinational State and Armed Forces in Bolivia

## Loreta Tellería Escobar

*Political Scientist and Master in Latin American Social and Political Studies.*

*Bolivia is constituted as a Social Unitarian State of Community Plurinational Law, which is free, independent, sovereign, democratic, intercultural, decentralized and with several autonomies. (Political State Constitution, Sec. 1)*

### The State Political Constitution

Since 2006, Bolivia has started a process of redesigning its political, economic and social structures. This brought about the breakup of the old state structures that had implemented a highly dependent liberal economy pervaded by a colonial spirit built since the inception of the Republic in the 19<sup>th</sup> century.

The challenges of the new State underpinned by the Political Constitution promulgated on February 9, 2009 have as a principle, the start of the decolonization cycle<sup>1</sup> in the country, which in effect, should occur at all State spheres, from the ministries to the last governmental agency existing at the boundaries. In reality, the concrete tasks required by this challenge are hindered by the very bureaucratic architecture the change of which is being sought. While the process is a response to a historically overlooked demand, the actions required by change call for a transformation of the people's mindset, which is in fact the hardest and slow objective to be attained.

1 In general terms, the Bolivian decolonization case can be observed at several levels: anti-imperialist fight, sovereignty, deconstruction of the colonial institutions and an environment with hierarchical and discriminatory relations, disassembly of the colonial State, elimination of a patriarchal state, emergence of alternative, pluralist and heterogeneous modernities. Raúl Prada Alcoreza, “¿Qué es la descolonización?”, Cambio, <http://www.cambio.bo/noticia.php?fecha=2010-03-24&idn=16304>.

### The New Armed Forces

In this new environment, the armed forces have to submit to a plurinational, intercultural, pacifist State that promotes a culture of peace,<sup>2</sup> which involves its institutional and doctrinary redesign. Plurality must be reflected in a strategic thinking reproducing the birth of the new Country.

At present, there is urgency for the commencement of a transition process, which should be framed in doctrinary, legislative and functional changes. All of this taking into account that in this process social movements and society as a whole prevail as the main actors of the process of change. In the new State structure, the fundamental stronghold of democracy is no longer the State institutions but the strength of an organized society.

From this perspective, changes must seek a new defence doctrine based on the following premises:

a) The culture of peace and the resignation of war as a result of a foreign defence and security policy at State level.

Bolivia's projection as a pacifist State requires the building up of a foreign policy elaborated jointly by the Ministry of Defence, the legislative branch and the Ministry of Foreign Affairs. This would not only consolidate the Country's vision, but would organize inter-institutional efforts, now uncoordinated, in relation to Bolivia's participation in military cooperation

2 “Bolivia is a pacifist State that promotes a culture of peace and the right to peace, as well as the cooperation among the nations of the region and the world. As a country it rejects every aggressive war as an instrument to solve disputes and conflict between States. In addition, no foreign military base may be installed in the Bolivian State.” Estado Plurinacional de Bolivia, *Constitución Política del Estado*, sec. 10.

agreements, confidence building measures and peace keeping missions. The organization of an external security and defence policy in Bolivia would be the most reliable expression of an attitude matching the principles claimed.

b) The recovery of sovereignty in international defence and security matters.

The main challenge of the new doctrine is to nationalize the defence and security policy, the first step in the decolonization process. This will demand the development of a broad debate and reflection on the whole area, aside from clear political guidelines on the type of armed forces to be organized from a plurinational State perspective.

c) The definition of the armed forces strategic horizon as regards territorial domination.

Territorial domination is a key factor in nationalization and decolonization processes in defence and security doctrine. The actual presence of the armed forces in border areas<sup>3</sup> entails not only an event-driven deployment but the transformation of the whole functional structure until now anchored to the country's urban centers and disconnected from the problems that relate to rural area security, including smuggling, arms and drug trafficking, etc. This new deployment could become the core of reform, as it would imply a new doctrinary, functional and operational framework that would bring the armed forces into contact with the social sectors that are most excluded and separated from political decisions, where the State is almost absent and with high insecurity levels.

d) The definition of the armed forces strategic role in external defence, support to development and associated tasks.

Over the past years, the armed forces have been in charge of tasks associated with support to development and humanitarian assistance in disaster situations. This allowed greater closeness to the society and resulted in an improvement of its perception of the armed forces. It also had direct impact on the development of new institutional capabilities. The challenge vis-a-vis these new roles is putting together a regulatory-institutional framework that may prioritize functions and organize the institution according to this functional prioritization. Otherwise, the risk would be

maintaining a traditional structure that accommodates to the roles designated to face any new situation and having they changed according to the political interest prevailing at any time, a procedure that would do nothing but prevent the institutional conformation of the country's defence area.

e) An active role of the armed forces in the protection of natural resources and mother earth (*madre tierra*).

The new State has as a premise the defence of mother earth and the armed forces has been involved in this work, under a vision of preservation of the environment related to the country's natural resources. This new area for military work, still scarcely addressed by academic studies, suggests a fundamental change which, despite any doctrinary loopholes, seems to be an immediate role.

f) A reform to the interior of the defence and armed forces institutions including education, military justice, interculturalism, gender and mandatory military service.

One of the main reforms within the armed forces is undoubtedly oriented to their internal institutional environment, with urgent matters including: i) A deep transformation of education, values and codes of conduct, a fundamental step towards the destructuring of the colonial mentality. ii) The strengthening of interculturalism inside the armed forces, which will lead to the harmonious participation of different cultures under equal conditions and the building up of institutions formed by diverse people. iii) The decolonization entails the demolition of the patriarchal and malechauvinist State; under this premise the armed forces must implement policies directed not only to the inclusion of women in their ranks, but also to a gender perspective mainstreaming. iv) The mandatory military service reform as a means towards the deconstruction of an institution with hierarchical and discriminatory relations, seeking for more innovative and democratic alternatives.

In sum, under the premise of the new plurinational State, the new armed forces of Bolivia must develop a new doctrine and a legislative framework to support it, always bearing in mind that the key to change lies not on the forms but at the very bottom of military members' mindsets. Decolonialization represents a breakup with the past: it cannot be conservative, functional or rhetorical; it needs to be creative and irreverent and for that a perfect dose of willpower, dedication and commitment to the new country is needed.

<sup>3</sup> "The fundamental duties of the Armed Forces are the defence, protection, and control of the border security areas. The armed forces shall take part in the policies of integrated and sustainable development of those areas and shall ensure their permanent physical presence in them". *Estado Plurinacional de Bolivia, Constitución Política del Estado*, art. 263.



# Brazil

## The Legal Framework and the Defence System

### National Legislation

#### Systems and Concepts

- Act which establishes the Deployment of Brazilian Troops Overseas (Nº 2.953 - 1956/11/20)
- Act which determines the Cases when Foreign Armed Forces can transit or remain temporarily in National Territory (Complementary Act Nº 90 - 1997/10/02)
- Act which institutes the Brazilian System of Intelligence, creates the Brazilian Agency of Intelligence – ABIN (Nº 9.883 - 1999/12/09)
- Act on the Organization and Operation of the National Defence Council (Nº 8.183 - 1991/04/11. Last amendment: 2001/08/31)
- Act on the Organization of the Presidency of the Republic and the Ministers (Nº 10.683 - 2003/05/28. Last amendment: MP 499/10 – 2010/08/25)
- Act which Rules over National Mobilization and creates the National System of Mobilization (Nº 11.631 - 2007/12/28)

#### Military Organization

- Military Pension Act (Nº 3.765 – 1960/05/04. Last amendment: Provisional Measure 2215-10 - 2001/08/31)
- Military Service Act (Nº 4.375 - 1964/09/03)
- Military Penal Code (Decree-Law Nº 1.001 - 1969/10/21. Last amendment: Act Nº 9.764 - 1998/12/17)
- Code of Military Penal Procedure (Decree-Law Nº 1.002 - 1969/10/21. Last amendment: Act. Nº 9.299 - 1996/08/07)
- Act on the Statute of the Members of the Armed Forces (Nº 6.880 - 1980/12/11)
- Act on Education at the Air Force (Nº 7.549 – 1986/12/11)
- Act on the Organization of Military Justice (Nº 8.457 - 1992/09/04. Last amendment: Act Nº 10.445 - 2002/05/07)
- Act on rendering Alternative Service to Compulsory Military Service (Nº 8.239 – 1991/10/07)
- Act on Education at the Army (Nº 9.786 – 1999/02/08)
- Act on Regulations for the Organization, Preparation and Use of the Armed Forces, to establish New Subsidiary Powers (Complementary Act Nº 117 - 2004/09/02; modifies Complementary Act Nº 97 - 1999/06/09)
- Act on Education at the Navy (Act Nº 11.279 – 2006/02/09)
- Complementary Act on Defence (Complementary Act Nº 136 – 2010/08/25; modifies Complementary Act Nº 97 - 1999/06/09)

Source: Compilation based on the legislation above mentioned. For constitutional provisions see Chapter 1.

- Advisory and assistance functional relationship
- Command reporting line
- - - Joint planning and management relationship

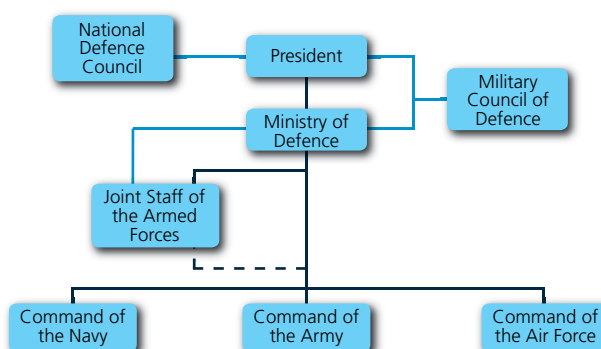

The President is advised by the National Defence Council, composed of the Vice President, the House Speaker and the President of the Federal Senate and the Ministers of Justice, Defence, Foreign Affairs and Economy. In matters related to the use of military resources, the President is advised by the Military Defence Council, made up of the Ministry of Defence, the Commanders of the Armed Forces and the Chairman of the Joint Chiefs of Staff. The Minister of Defence holds the highest command of the Armed Forces. The Minister receives the advice of the Joint Staff, responsible for planning for the joint employment of the Armed Forces. The Congress holds the powers granted by the Constitution and permanently monitors defence related issues through the foreign affairs and defence committees in both Houses.

Source: Compilation based on the Political Constitution, *Lei que dispõe sobre a organização e o funcionamento do Conselho de Defesa Nacional e dá outras providências* (Nº 8.183 – 1991/04/11. Last amendment: 2001/08/31), *Lei sobre as Normas Gerais para a Organização, o Preparo e o Emprego das Forças Armadas* (Complementary Act Nº 97 - 1999/06/09. Last amendment: Complementary Act Nº 136 – 2010/08/25).

## The Budget

Year	Defence Budget (in US\$)	Government Budget (in US\$)	GDP (in US\$)
2006	13,692,057,669	633,054,904,995	784,509,000,000
2007	20,973,055,774	795,899,305,906	1,295,355,000,000
2008	26,202,709,813	832,977,021,070	1,621,274,000,000
2009	25,911,333,511	814,083,164,256	1,481,547,000,000
2010	33,055,029,481	1,022,213,470,647	1,910,495,000,000

### Defence Budget (in %)

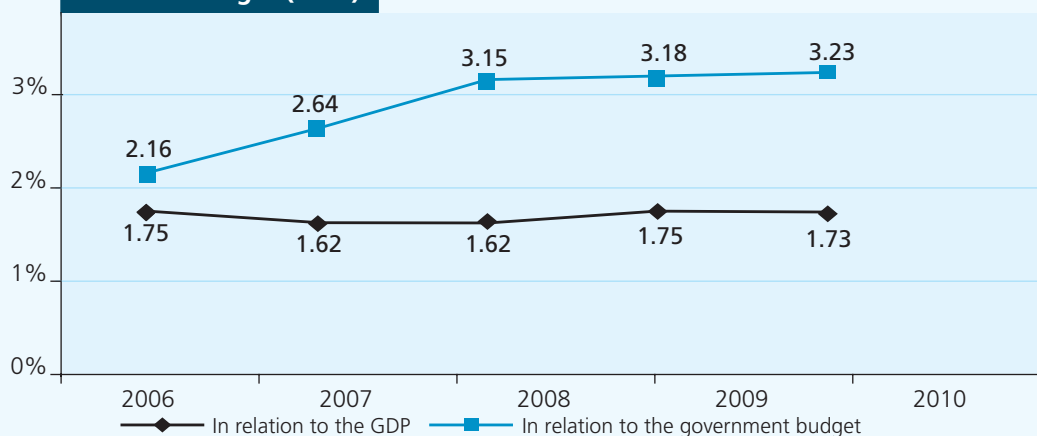

Defence Budget Breakdown

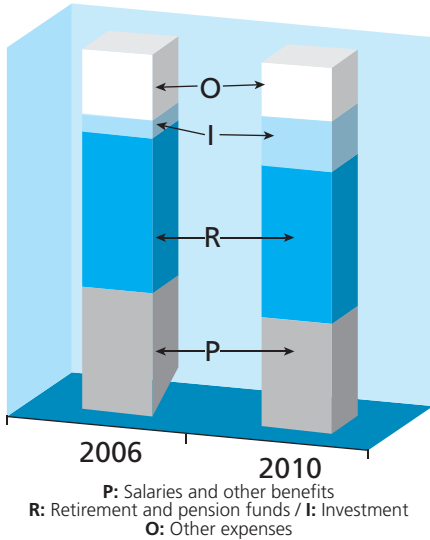

Comparative Increase (% variation 2006-2010)

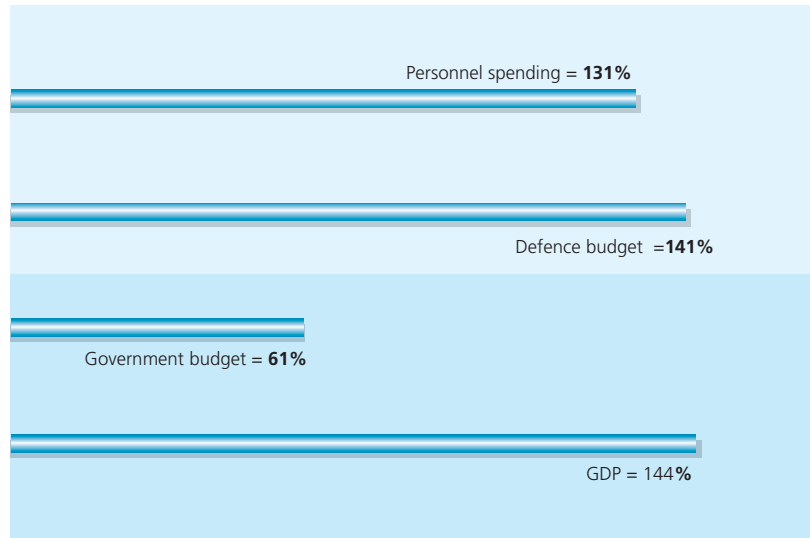

Defence Budget 2010 (in Local Currency)

Fiscal and Social Security Budget	Personnel and Benefits	Other Current Expenses	Others*	TOTAL
<b>Ministry of Defence</b>				
Ministry of Defence	40,743,119	435,353,200	803,740,553	1,279,836,872
Command of the Air Force	9,536,128,148	1,238,239,019	2,958,042,659	13,732,409,826
Command of the Army	21,917,851,050	1,672,959,556	640,767,930	24,231,578,536
Command of the Navy	10,874,403,471	936,949,732	2,873,649,544	14,685,002,747
Directorate of the Interministerial Commission for Maritime Resources	0	7,528,736	1,802,703	9,331,439
National Civil Aviation Agency	144,681,366	189,851,605	19,508,395	354,041,366
Real Estate Fund of the Air Force	698,988	2,357,426	4,979,000	8,035,414
Warfare Material Industry of Brazil (IMBEL)	33,365,193	142,400,280	44,900,000	220,665,473
Osório Foundation	6,916,626	3,810,155	388,000	11,114,781
Housing Construction Fund for the Brazilian Navy Personnel (CCCMB)	1,923,135	14,339,610	0	16,262,745
Ministry of Defence Fund	0	1,737,517	715,021	2,452,538
Administration Fund of the Armed Forces Hospital	122,125,039	46,690,934	7,732,000	176,547,973
Military Service Fund	0	5,398,043	1,126,730	6,524,773
Air Force Fund	0	893,742,302	1,191,722,973	2,085,465,275
Army Fund	0	741,871,356	71,211,735	813,083,091
Navy Fund	0	290,299,841	140,507,325	430,807,166
Fund for the Maritime Professional Education	0	83,411,326	32,061,012	115,472,338
<b>Military Justice of the Union</b>	299,597,015	41,678,272	7,704,000	348,979,287
<b>Military Public Ministry</b>	115,457,616	22,384,400	1,000,000	138,842,016
Subtotal	43,093,890,766	6,771,003,310	8,801,559,580	
<i>Investment Budget</i>				
<b>Ministry of Defence</b>				1,493,700,000
<b>TOTAL</b>				<b>60,160,153,656</b>

\*Includes interests and debt payments, investment, public investment, debt recovery/repayment and contingency reserve.

Composition of Defence Budget 2010

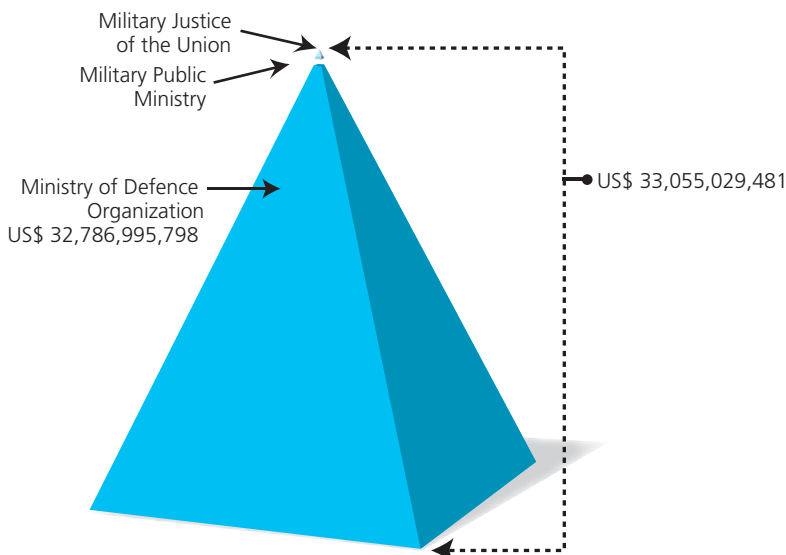

One of the most significant military acquisitions is the agreement signed with France in 2009 for submarine building (See page 159).

**Source:** Compilation based on *Ley que estima los ingresos y fija los gastos de la Unión for fiscal years 2006, 2007, 2008, 2009 and 2010*. The State Budget passed by the Congress by means of the above mentioned Act is considered herein. The concept of investment is that expressed in Fiscal and social security budget investments and investment Budget.

GDP: Projection of the World Economic Outlook Database, IMF, of each year under review. This source has been taken for comparative purposes. Each country makes the budget based on its own GDP estimation. The dollar value considered corresponds to the exchange rate determined by the World Economic Outlook Database, IMF, for each year under consideration. As of July, the 2010 exchange rate average is 1.79 Reales, based on the data provided by the Central Bank of Brazil. For further calculations, figures are provided in local currency. Expressions in Bold Type (Table) make reference to the various defence budget items, which can be found in a sector-based or institutional classification of the Budget Act.





### The Ministry of Defence

The Minister of Defence exercises the senior leadership of the Armed Forces, on the advice of the Military Council of Defence as the permanent consultation body, the Joint Staff of the Armed Forces, the secretariats and other bodies, in accordance with the law.  
 (Lei sobre as Normas Gerais para a Organização, o Preparo e o Emprego das Forças Armadas, Complementary Act Nº 97 - 1999/06/09. Last amendment: Complementary Act Nº 136 - 2010/08/25, Sec. 9)

#### Organization Chart

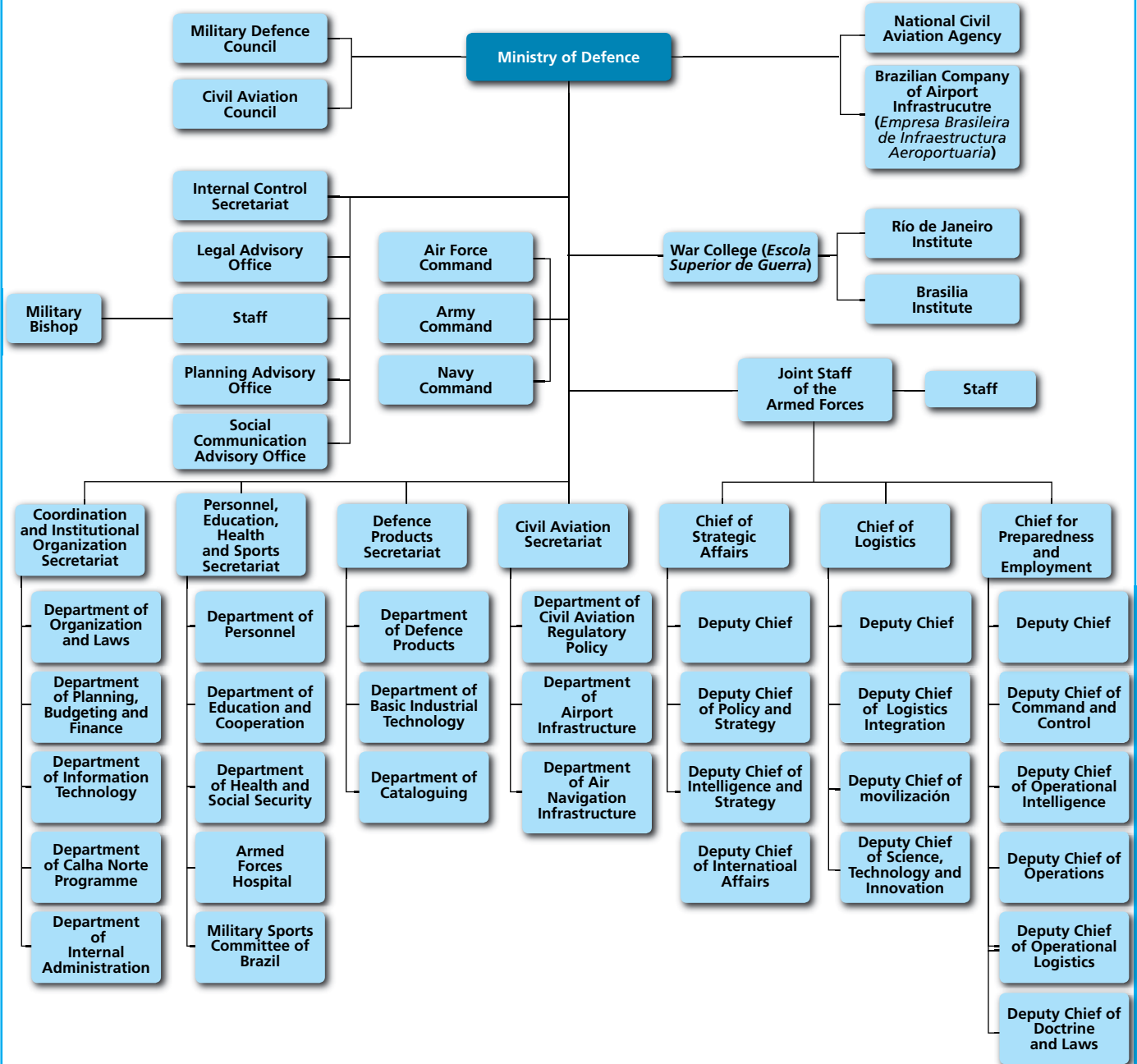

<b>Date of Foundation:</b> 1999
<b>Current Minister (September 2010):</b> Nelson Jobim
<b>Can military members be Ministers of Defence?:</b> Yes (if they have retired)
<b>Number of military members who were Ministers of Defence:</b> None
<b>Number of civilians who were Ministers of Defence:</b> 5
<b>Have there been any women in charge of the Ministry of Defence?:</b> No
<b>Average permanence in the Minister of Defence position:</b> 1 year and 7 months

[The Minister currently in charge is not considered. The creation date is related to the moment in which the term "Defence" becomes part of the Institution's name]

Source: Compilation based on information provided by the Ministry of Defence.

**Political Definitions**

**Policy Guidelines**

Brazil is a peaceful country by tradition and conviction. It lives at peace with its neighbours. It manages its international relations under the constitutional principles of non intervention, defence of peace and peaceful settlement of disputes. This trace of pacifism is part of its national identity and a value that must be preserved by the Brazilian people. The national defence strategy is inseparable from the national development strategy. The latter drives the former, and the former provides a shield to it. Both strategies reinforce each other's underlying principles. In both, the focus is placed on nationality and nation building. If defended, Brazil has the ability to say "no", when it has to. It shall have the capability to build its own development model.

**It is based on three fundamental principles:**

- How the Armed Forces must be organized and focussed in order to accomplish their constitutional mission and role in times of peace and war.
- The reorganization of the national defence industry to ensure that needs for equipment may be supported by national industry technologies.
- The composition of Armed Force personnel and, consequently, the future of the compulsory military service.

**It shall be governed by the following guidelines:**

1. Deter the concentration of hostile forces on the ground frontiers and Brazil's jurisdictional waters and prevent the use of the national air space. To deter, however, it is necessary to be prepared for combat.
2. Organize the Armed Forces under the monitoring/control, mobility and presence trinomial umbrella.
3. Develop capabilities to monitor and control the air space, territory and territorial waters of Brazil.
4. Develop the capacity to quickly respond to any threat or aggression: strategic mobility.
5. Strengthen the connection between the technological and operational aspects.
6. Strengthen the three sectors of strategic importance: space, IT and nuclear energy.
7. Unify the operations of all three Services
8. Reposition the three Services personnel.
9. Concentrate the presence of Army, Navy and Air Force units on the border areas.
10. Prioritize the Amazon region.
11. Develop the logistics capability, in order to strengthen mobility.
12. Develop the concept of flexibility in combat.
13. Develop operational practices and training.
14. Promote in the Brazilian militaries the skills and attributes required by the concept of flexibility.
15. Review, following the policy of human resource optimization, the composition of the three Services' personnel.
16. Lay out the strategic potential around capability-based criteria.
17. Train troops for the fulfillment of missions aimed at securing law and order under the terms specified in the Federal Constitution.
18. Promote the integration of South America.
19. Prepare the Armed Forces to operate under their growing role in peacekeeping operations.
20. Enhance their capacity to meet international SAR commitments.
21. Develop the potential of military and national mobility to ensure the deterrence and operational capability of the Armed Forces.
22. Provide training to the national defence industry enabling it to acquire the capabilities necessary on technologies that are essential for defence.
23. Maintain the draft system (conscription).

Brazil published the *Política de Defesa Nacional* (National Defence Policy) in 1996 and 2005 and the *Estratégia Nacional de Defesa* (National Defence Strategy) in 2008.

Source: *Estratégia Nacional de Defesa, 2008.*

**Reports Submitted to the United Nations and the OAS**

1997	1998	1999	2000	2001	2002	2003	2004	2005	2006	2007	2008	2009
✘	✘	✘	✘	✘	✘	✘	✘	✘	✘	✘	✘	✘
◊	◊	◊	◊	◊	◊	◊	◊	◊	◊	◊	◊	◊
✱				✱	✱				✱			✱

Register of Conventional Arms: ✘ Register of Military Expenditures: ◊ Implementation of Confidence and Security Building Measures: ✱

Source: Compilation based on reports submitted to the United Nations Register of Conventional Arms and the United Nations Instrument for Reporting Military Expenditures and reports submitted to the OAS on the Implementation of Confidence and Security-Building Measures.

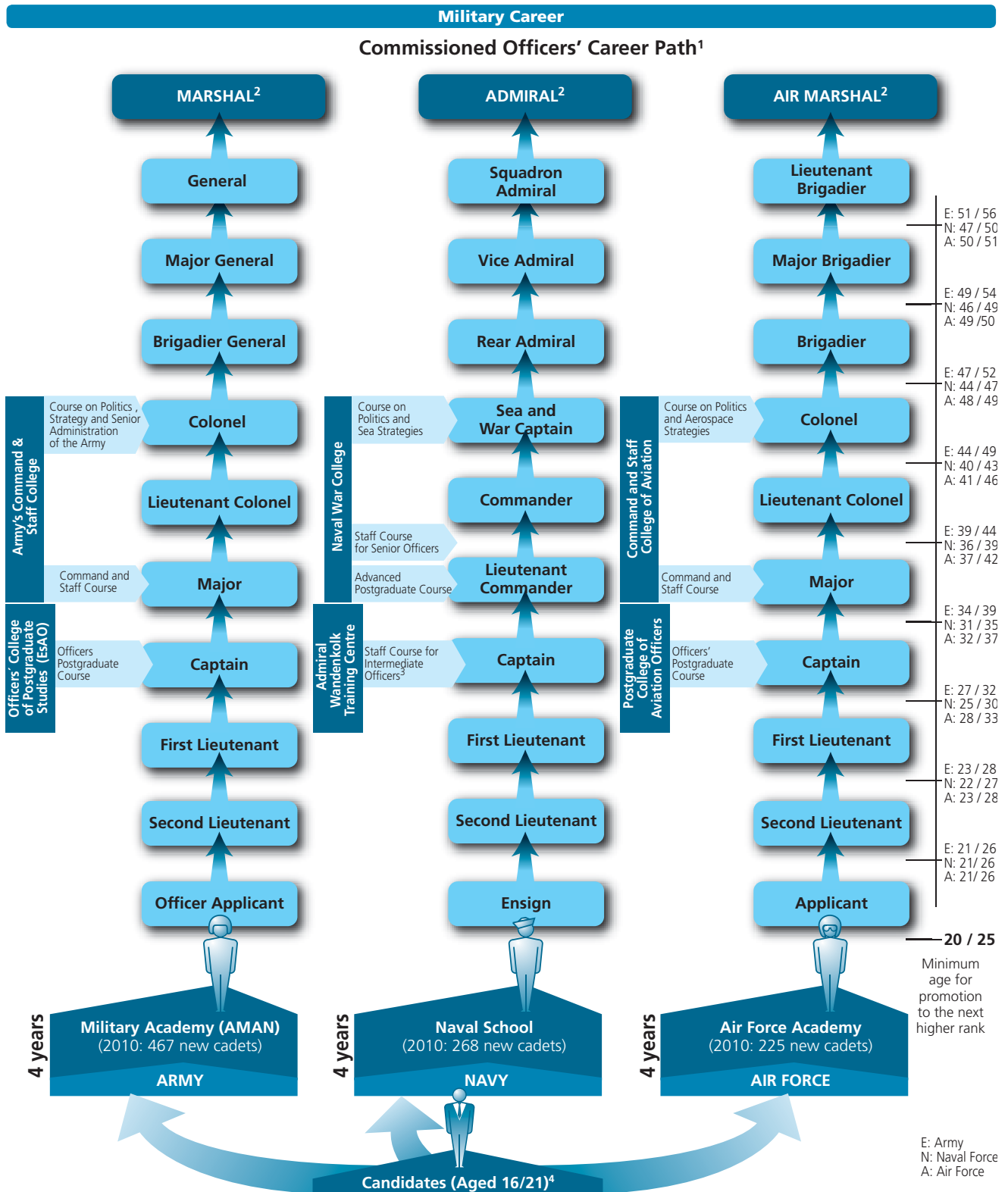

<sup>1</sup> Command corps includes officers who have been educated at military academies from the beginning of their professional careers. The graph makes a theoretical reconstruction of officers promotion through the completion of mandatory courses. Further requirements for promotion have not been considered.

<sup>2</sup> Ranks are granted only in war times.

<sup>3</sup> This course is given at the Naval War School.

<sup>4</sup> Ages of 16-21 years old have been considered for comparative purposes. Entry age varies depending on the services: Army 15-20 years old, Naval Force 18-22 years old, Air Force 17-22 years old. The minimum age for promotion will depend on the age of graduation from the military education institution.

**Source:** Compilation based on *Ley de estudios en el Ministerio de Aeronáutica* (N° 7.549 – 11/12/1986), *Ley que rige educación en el Ejército* (N° 9.786 – 08/02/1999), *Ley que regula la educación en la Armada* (N° 11.279 – 09/02/2006), *Ley sobre el Estatuto Militar* (N° 6.880 - 11/12/1980), Decree N° 3998 – 05/11/2001, Decree N° 71.727 – 17/01/1973, Portaria 508/GC1 – 29/07/2010. New cadets: Information provided by the Armed Forces.

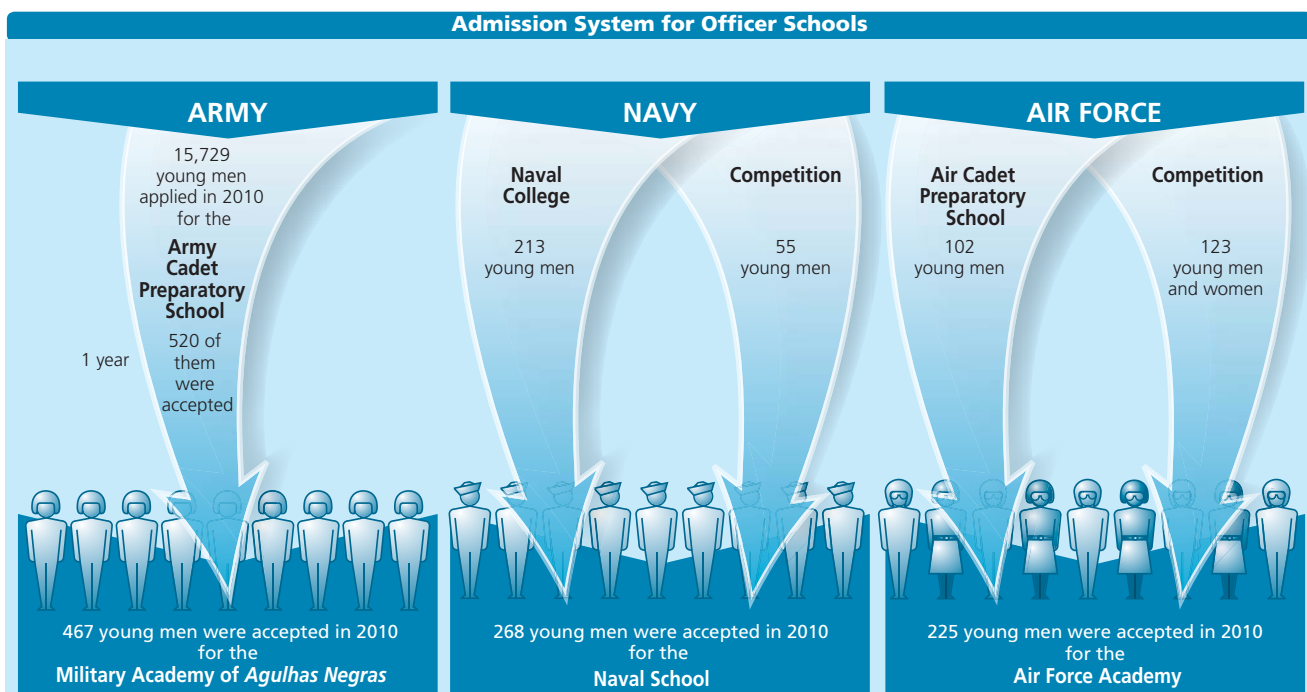

#### War College (*Escola Superior de Guerra - ESG*)

This is a higher education institute which directly reports to the Minister of Defence, aimed at developing and consolidating the necessary knowledge to conduct national security leadership and planning roles. It was created by Act N° 785 dated 20 August 1949 and is currently located in the city of Rio de Janeiro. In 2009, it trained 154 people.

Courses	Participants			People Trained in 2009
	Military personnel	Civilians	Other Nations	
Course of Higher Political Studies and Strategy	X	x	x	77
Senior Course of Strategic Intelligence	X	x		28
Course of Logistics and National Mobilization	X	x		28
Combined Staff Course	X			21
Defence Resource Management Course	X	x		-
Law of Armed Conflicts Course	X	x		-
Updating Course	X	x		-

#### Pro- Defesa – Programme for the Support of Science and Technology Teaching and Research in National Defence

This action of the Brazilian government is aimed at promoting cooperation between civilian and military institutions to implement projects seeking the promotion of education, science and technology research and qualified human resource training in the national defense area. The programme is executed by way of a collaboration between the Ministry of Defence and the Foundation for the Coordination of Senior Personnel Training (Capes).

#### Rondon Project – Defence, Universities and Society

Launched in 2005, this Project is coordinated by the Ministry of Defence in collaboration with state and municipal governments and civic organizations. It is a project seeking for the integration of students to the national development process. It implies the voluntary participation of university professors and students for the purpose of finding solutions that contribute to the sustainable development of poor communities and enhance the population's wellbeing. The project intends to put students in contact with the reality of the country and contribute to the development of the communities served. The Armed Forces provide the logistic support required for the operations.

The main activities involve communication, culture, human rights and justice, education, environment, technology and production, health and employment.

**Received Proposals (operations to be performed in January, 2011): 882**  
**Approved and Selected Proposals: 151**

**Source:** Websites of the Ministry of Defence, the Armed Forces and the War College. Accepted candidates (military schools): information provided by the Armed Forces.



## The Armed Forces

### General Mission

Aimed at defending the Motherland and guaranteeing constitutional powers and, upon the initiative of any of these powers, protect law and order. (Constitution, Sec. 142)

Subsidiary Powers:

- Participate in peace operations.
- Cooperate with national development and civil defence.
- Take part in institutional campaigns of public and social interest.
- The Armed Forces are responsible, among other pertinent activities, for subsidiary functions, preserving the exclusive competences of the law-enforcement forces, by means of preventive and repressive measures in border regions, both

at sea and interior waters, regardless of the ownership or destination, acting against transborder and environmental crimes, executing actions including:

- I – patrolling;
- II – control checks of individuals, ground vehicles, ships and aircraft;
- III – arrests in flagrant crime commission.

(Lei sobre as Normas Gerais para a Organização, o Preparo e o Emprego das Forças Armadas, Complementary Act N° 97 – 1999/06/10. Last amendment: Complementary Act N° 136 – 2010/25/08, Sec. 15 and 16).

### Specific Missions

#### Army

Subsidiary Powers:

- Participate in national development and civil defence, in accordance with the law.
- Contribute to making and implementing national policies on land military power.
- Cooperate with federal agencies, with state, municipal and exceptionally with private companies, in the execution of engineering works and services, using the resources provided by the requesting organization.
- Cooperate with federal organizations when necessary to repress crimes of national impact, providing logistic support, intelligence, communications and training.
- Act, through preventive and repressive actions, in land border areas, against cross-border and environmental crimes, individually or in coordination with other bodies of the Executive Branch, carrying out, within hours, patrolling; checking of individuals, land vehicles, ships and aircraft; arrests in cases of flagrant crimes.

#### Navy

Subsidiary Powers:

- Guide and control the Merchant Marine and its related activities, in relation to national defence.
- Provide water navigation security.
- Contribute to making and implementing national policies related to water navigation.
- Implement and supervise compliance with the laws and regulations of the sea and interior waters, in coordination with other bodies of the Executive Branch, federal or state, when necessary, related to specific competencies.
- Cooperate with federal bodies, when necessary, in repressing crimes with a national or international impact, regarding the use of the sea, interior waters and port areas, providing logistics, intelligence, communications and training support.

#### Air Force

Subsidiary Powers:

- Guide, coordinate and control Civil Aviation activities.
- Provide security to air navigation.
- Contribute to making and implementing national policies related to airspace navigation.
- Establish, equip and operate airspace, aviation and airport infrastructure, directly or through an operator.
- Operate the national air mail.
- Cooperate with federal bodies, when necessary, in repressing crimes with national or international impact, in relation to the use of air space and airport areas, providing logistic support, intelligence, communications and training.
- Act continuously and permanently, through actions of control of the Brazilian air space, against all kinds of illegal air traffic, with emphasis on drug, arms and ammunition trafficking and illegal passengers acting in coordination with the competent supervising bodies which will force the aircrafts involved in illegal air traffic to land.

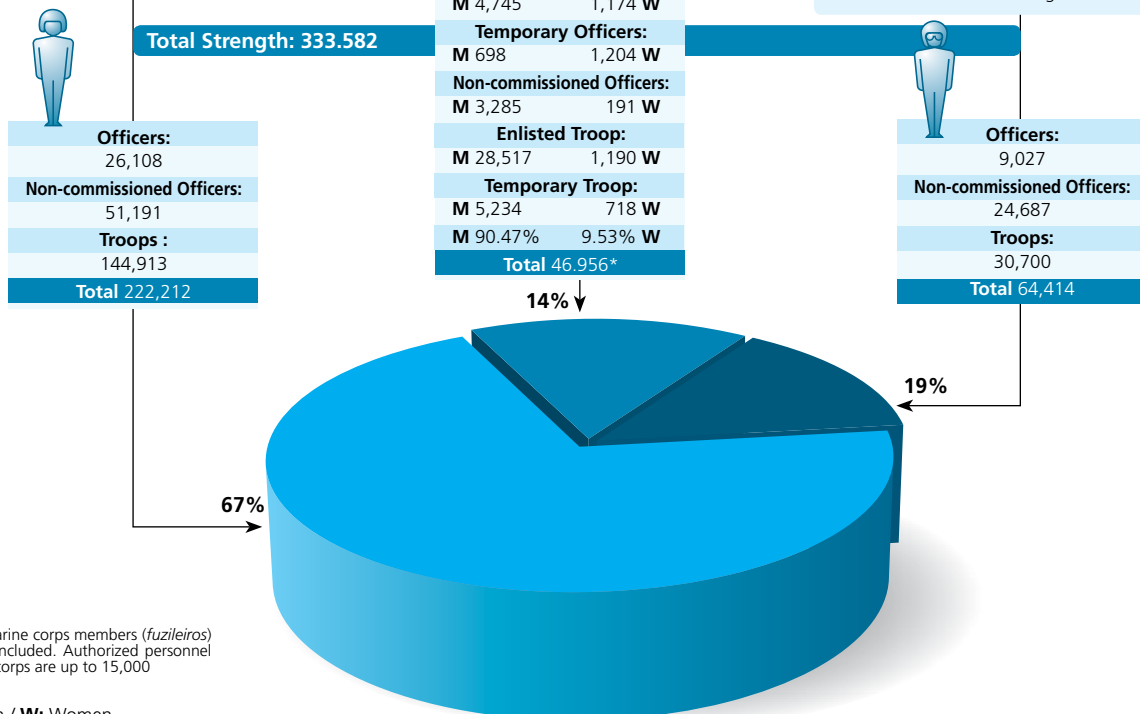

Source: Lei sobre as Normas Gerais para a Organização, o Preparo e o Emprego das Forças Armadas (Complementary Act N° 97 - 1999/06/09. Last amendment: Complementary Act N° 136 – 2010/08/25) (missions). Decree N° 7.173(2010/05/11), Decree N° 7.230 (2010/07/12), Navy of Brazil, and website of the Social Communication Center of the Air Force (Regular Forces).

### Women in the Armed Forces

#### Women's Admission to the Armed Forces (year)

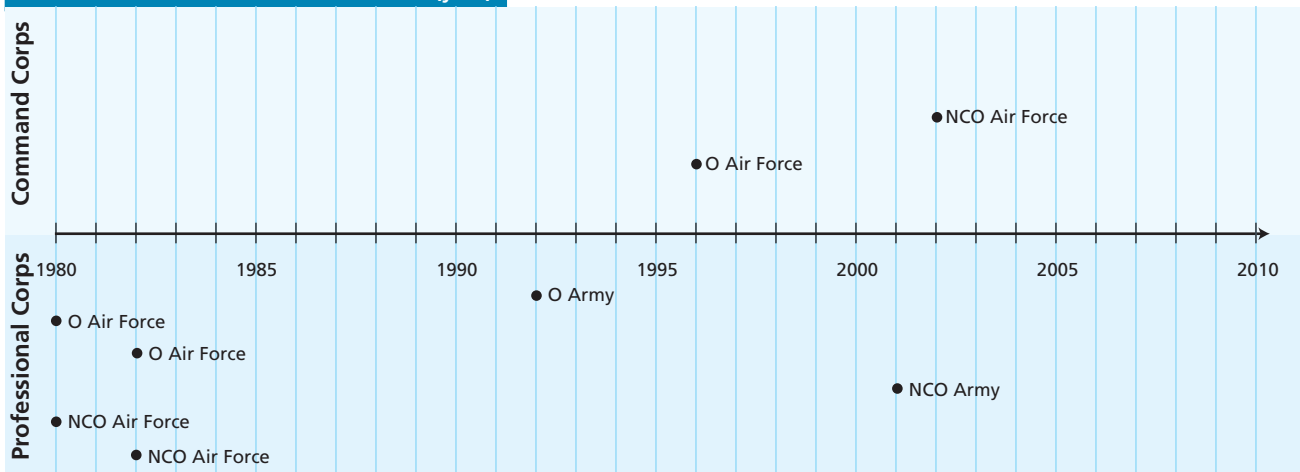

O: Officers - NCO: Non-commissioned Officers

**Note:** Women are not admitted as officers and NCO's of the command corps of the Ground and Naval Forces. The Command corps includes officers who have been educated at military academies from the beginning of their professional careers. The Professional corps refers to those who develop a career in the civilian sphere and are then incorporated to the armed forces..

#### Women Officers who have reached the highest rank in the Command Corps (2010)

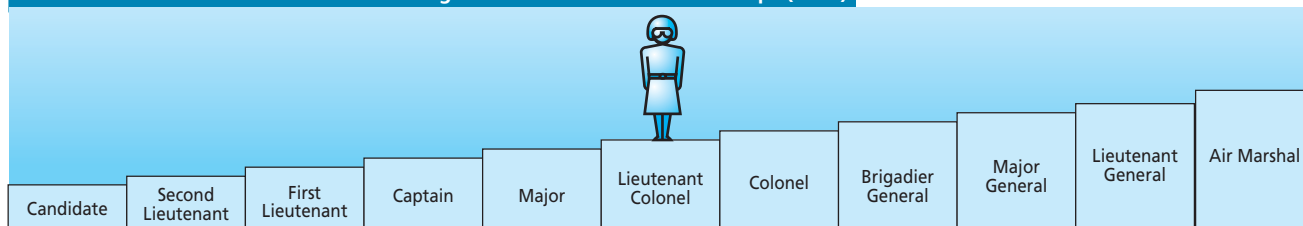

**Note:** These ranks correspond to the Air Force. There are no women in the command corps of the Army and the Navy.

**Source:** Compilation based on information provided by the Armed Forces and Project 07-184 Global Peace and Security Fund-RESDAL.

### Military Service

It is mandatory for all male citizens for the period of one year. Upon turning 17 years old, male citizens may also offer themselves for voluntary service. Women are exempt from military service in times of peace; however, they may offer themselves for voluntary service.

A special regime is available for Medicine, Pharmacy, Odontology and Veterinary School students and graduates.

In the Brazilian Navy, for instance, information for 2009 and 2010 is as follows enlisted by Naval District:

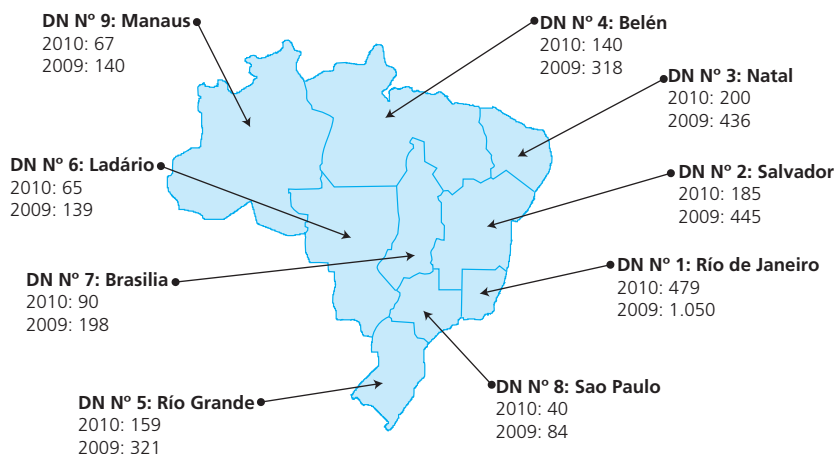

	MFDV (Initial Military Service for Officers)		SMV (Voluntary)	
	Men	Women	Men	Women
2009	161	29	103	199
2010	156	99	149	326

Total enlisted individuals in 2009: 3,131; in 2010: 1,425.

2010 data include the first round of enlisting (March). The second round is still in process (September 2010). DN: Naval District

	Number of Enlisted	
	year 2009	year 2010
Army	61,610	89,138
Air Force	6,553	5,714
<b>TOTAL</b>	<b>71,320</b>	<b>97,740</b>

#### Soldier-Citizen Project

Launched in August 2004, its purpose is to provide social and professional qualifications to enlisted citizens who attend military service for their subsequent entry to the work force. It comprises all the national territory and is based on agreements between the Forces and various institutions that provide training courses. It included 119,152 young citizens between 2004 and 2009.

The National Defence Strategy provides for the establishment of a social service for those individuals who are not enlisted.

There is also an alternative military service involving administrative, charitable, productive and assistance activities which may replace strictly military functions. It is available for citizens alleging conscientious objection due to religious, philosophical or political reasons. Its term is eighteen months.

**Source:** Information provided by the Navy and the Ministry of Defence; *Estratégia Nacional de Defesa*, 2008; *Lei do Serviço Militar* (Nº 4.375 – 1964/09/03) and *Lei de prestação do Serviço Militar pelos estudantes de Medicina, Farmácia, Odontologia e Veterinária e pelos Médicos, Farmacêuticos, Dentistas e Veterinários* (Nº 5.292 – 1967-06/08).



**Defence and National and International Community**

**Participation in Peace Operations**

Current Missions	Military Component			
	MEM		MC	
	Men	Women	Men	Women
MINURSO (Western Sahara)	10	-	-	-
MINUSTAH (Haiti)	-	-	2,295	13
UNFICYP (Cyprus)	-	-	1	-
UNMIL (Liberia)	2	-	2	-
UNMIN (Nepal)	6	-	-	-
UNMIS (Sudan)	20	-	2	-
UNMIT (East Timor)	4	-	-	-
UNOCI (Ivory Coast)	4	-	3	-

MEM: Military experts on mission, including military observers, judge advocates and military liaison officers, among others - MC: Military Contingent.

**Source:** Compilation based on documents from the Department of Peacekeeping Operations of the United Nations. Data as of 31 August 2010.

The Joint Centre for Peacekeeping Operations in Brazil (CCOPAB) was created on July 15, 2010 by Portaria Nº 952 of the Ministry of Defence. It includes the Training Centre for Peacekeeping Operations (CI OP PAZ), created on February 23, 2005.

The *Fuzileros Navais* Peacekeeping School (EOPAZ) trained 12 individuals in 2009 in the Special Course for Staff of UN Observer Member States, and 7 people in the Humanitarian Demining Course.



Brazil contributes 2,362 military troops to the United Nations peacekeeping missions, which represents 30.88% of the total contribution of Latin America.

**Support Actions**

The Armed Forces regularly conduct various community support operations throughout the country. Some of their activities include:

**Navy**

- Between January and April, Navy personnel visited 52,726 homes in Rio de Janeiro to fight dengue.
- They transported 70 tons of food, medicines and clothing to provide aid to flooding victims.
- Winter clothing donation campaign for poor people in the Southern area of Brazil.
- Medical support to 2,106 people in aboriginal communities.

**Air Force**

- It transported more than 400 tons of food, medicines, clothing and mattresses for flooding victims.
- In April, it conducted social and civic actions with the provision of specialized health care to 495 people.
- In March, 1,800 medical visits in support of campaigns to fight dengue.
- Medical support to 39,200 people and vaccination of 2,500 in the Amazonas.

**Army**

- Between January and April 2010, Army personnel visited more than 300,000 homes in Manaus to fight dengue.
- In July, they participated in actions against influenza H1N1 in 75 border districts in more than 10 states.
- Support to flooding victims.

**Fuente:** Information provided by the websites of the Ministry of Defence and the Armed Forces.

**Defence Industry Programme**

The programme was launched in May 2008 and is part of the Productive Development Policy, with the involvement of several Brazilian government agencies. The goal is to invest 1.4 billion reais (approximately 900 million dollars) in modernization and research & development with a 2020 horizon.

**Increasing Domestic Procurement:**

- Increase government procurement of national equipment, especially for Armed and Law Enforcement forces improvement and modernization.
- Regulate procurement by promoting the contracting of local suppliers.

**Financing Expansion and Adequacy:**

- Expand reimbursable and non-reimbursable resources for R&D and human resource training.
- Support the national defence industry by offering counterparts and guarantees for export

**Promoting Sales and Training of Brazilian Companies:**

- Finance the participation of national companies for the creation of international holding companies.
- Create distribution and supply channel management programmes to strengthen Brazilian brands abroad.
- Support national certification adequacy on the international level.
- Strengthen participation in trade fairs and national and international conferences.

**Enhancing the Research and Development Base:**

- Expand national training on strategic areas of defence interest.

In 2009, 24 Armed Forces projects were selected, six of which are part of the first execution phase:

**Navy:** Development of high performance carbon fibre and high power microwave lab (LaMP).

**Army:** Armored vehicle for personnel transportation and SABER M-60 Radar.

**Air Force:** Air-to-air missile project (A-DARTER) and inertial system project for space applications.

**Source:** : *Política de Desenvolvimento Produtivo. Programas Mobilizadores em Áreas Estratégicas. Complexo Industrial de Defesa*, May 2008 and September 2009. *Defence Industrial Park Programme, Relatório de Acompanhamento de Execução da Agenda de Ação*, June 2010.

The Armed Forces in the Amazonas

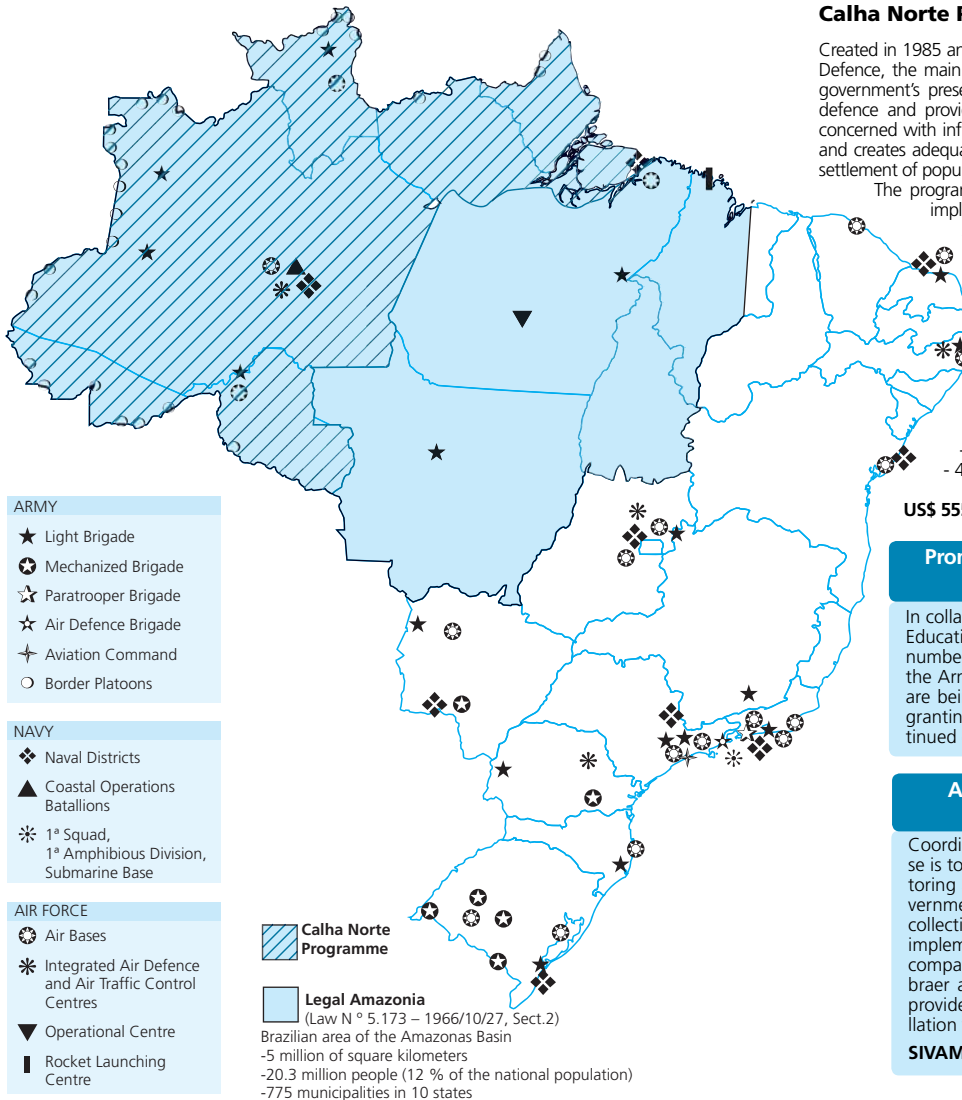

Calha Norte Programme

Created in 1985 and currently under the scope of the Ministry of Defence, the main goals of the programme are to increase the government's presence in the area by contributing to national defence and providing assistance to individuals. It is especially concerned with infrastructure works and promotes development and creates adequate conditions for the local establishment and settlement of population.

The programme's strategy is based on two main areas: implementation and expansion of Navy, Army and Air Force military units and support of environment-friendly sustainable social development.

The Project comprises:

- 194 municipalities (95 located on the border).
- 10,938 kilometers of border.
- 6 states: Acre, Amapá, Amazonas, Pará, Rondônia and Roraima.
- 32% of the national territory.
- 8 million people.
- 46% of the national aboriginal population.

US\$ 555 million between 2003 and 2009

Promoting the Transfer of Physicians to the Legal Amazon

In collaboration with the Ministries of Health and Education, this project aims at increasing the number of physicians who temporarily serve in the Armed Forces in the Amazon region. Studies are being currently conducted to implement the granting of scholarships and the provision of continued education programmes for physicians.

Amazonia Surveillance System (SIVAM)

Coordinated by the Brazilian Air Force, its purpose is to conduct air traffic surveillance and monitoring activities. It also organizes the various government entities in charge of these activities by collecting and processing information. SIVAM's implementation began in 1997. The US-based company Raytheon and Brazilian companies Embraer and Fundación Atech were contracted to provide the necessary equipment. System installation was completed in July 2005.

SIVAM deployment cost was US\$ 1.4 billion.

Submarine Development Programme (PROSUB)

Its purpose is to supply submarines to the country by 2021. The programme's fiscal impact began in 2009 and will end in 2024.

The agreement entered into Brazil and France regarding submarine development, which was executed on December 23, 2008, establishes the procurement of four Scorpène submarines (the first submarine to be assembled in France and the others in Brazil) with full technology transfer. It also includes support by France for long-term development and construction in Brazil of a nuclear-powered submarine. The nuclear reactor and its associated systems will be fully developed and produced in Brazil. France will provide assistance in the design and installation of a shipyard for submarine construction and maintenance and a naval base to host them.

Economic – Financial Aspects	
Description	Price (€)
Material for 4 SBRs and their respective logistic support	1,674,853,000.00
Construction of 4 S-BR submarines	756,200,000.00
Nuclear-powered submarine (SN-BR), except for the reactor	700,000,000.00
SN-BR construction	551,000,000.00
Equipment and sensors	99,700,000.00
Shipyard and naval base	1,785,000,000.00
Contract management	215,000,000.00
Technology transfer	908,580,000.00
<b>TOTAL</b>	<b>6,690,333,000.00</b>

Source: Compilation based on information provided by the the Ministry of Defence, Federal Senate, Amazonia Surveillance System and *Acuerdo entre Brasil y Francia en la área de Submarinos*, 2008.





Analisis:

## Defence policy in Brazil

**Shiguenoli Miyamoto**

*Professor, Political Science, Universidade Estadual de Campinas*

With 15,621 km of land borders, 10,959 km of sea shores and 193 million people over an 8.2 million square km surface area, combined with plenty natural resources, Brazil has demands beyond the South American regional level. Certainly, that is its closest area of influence and of significant importance in political, economic and strategic terms, but it is not necessarily its main priority at all times.

In order to meet all the demands it has, which are considered legitimate in terms of its attributes --such as having a permanent seat in the United Nations Security Council, leading positions in international institutions and a prominent role in the world power context-- the country has invested in several fronts at the same time.

Brazil has had an intense participation in multilateral organizations, marked its presence in UN peace operations, has maintained a strong relation with emerging countries (India, China, Russia and South Africa) and has established privileged links with the rest of countries in the Southern hemisphere, without neglecting keeping up its good relations with the strongest powers.

Together with its attempt to occupy more space in the world's political and economic arenas, over this decade Brazil has been concerned with another variable that until not very long used to attract only a secondary interest: the defence and armed force re-equipping policies. In the first place, seeking to create a solid defence industry, capable of meeting internal demands and serving also as an important source of resources by selling weapons to other countries. Second, the concern for acquiring more sophisticated equipment from more industrialized nations, seeking

to partner with them and requiring technology transfer as consideration, for the purpose of leaving behind the role as mere equipment assemblers.

Although the Brazilian military sector has had good experiences in the 1970s after *Industria de Material Bélico de Brasil* (IMBEL --Brazilian War Material Industry) was created in 1975, this organization did not last through the '80s, except for certain companies still surviving. The current policy for the defence industry has considered several aspects developed over the past years: the preparation of the first political document on *National Defence Policy* (PDN) in 1996, the creation of the Ministry of Defence in 1999, the new updated version of the *National Defence Policy* in 2005, and the most important initiative for the area, the *National Defence Strategy* (END) drafted in December 2008, which was about strengthening the country in strategic and military terms.

With its ambitions and the recent discovery of energy resources along the Brazilian littoral (*pré-sal*), strengthening the military vector has become imperative for the purpose of protecting the region where oil reserves are located and the whole territory of Brazil, especially the Amazonia. These concerns are duly represented in the documents mentioned above, where the Amazonian region and the South Atlantic (also known as the Blue Amazonia) are considered priority areas for Brazilian strategy.

Certain lines have been established in the END to strengthen the strategic-military sector; among them, the reorganization of the armed forces and the restructuring of the defence material industry. In addition, special attention should be paid to mandatory military service, which would be the source of the

troops to counter any problems that could arise. The Brazilian armed forces are estimated to have close to 300,000 members (equivalent to 0.15% of the population), a modest figure if compared to the big powers, and below the actual needs.

In turn, the defence industry moves a large apparatus involving the government and the private sector. More than 300 facilities manufacturing military equipment are registered with the Ministry of Defence and there are at least 700 companies indirectly related to this activity. The plan is defined by the National Policy for the Defence Industry (DINP) through Resolution No. 899 of July 19, 2005, and by the Brazilian Agency for Industrial Development (ABDI) created in 2004.

Certain organizations appeared in the private sector, including the Defence Industry Production Chain Committee (COMDEFESA), created in 2004 by the powerful Sao Paulo State Industry Federation (FIESP) and later on transformed into a department of the FIESP in December 2007. It maintains relations with the ministries of Defence; of Development, Industry and Foreign Trade; and of Science and Technology, aside from other governmental agencies. There is also the Brazilian Association of Defence and Security Industries (ABIMDE) which has more than 100 member companies.

The defence industry accounts for 0.8% of the GDP and has 0.1% share of the world defence market, which places Brazil as the 37th largest weapon exporter.

For the END to become a reality and its directives to be attained, the government proposed certain changes in the political-institutional front. Thus Complementary Law 97 (LC 97 of 1999) and Complementary Law 117 (LC 117 of 2004) have been amended to reflect the demands implicit in the END. LC 97 established the general rules for the organization, preparation and employment of the armed forces and the Ministry of Defence's tasks. In turn, LC 117 has added an article to LC 97 expanding the role of the Army, allowing it to exercise policing and repression functions along national borders and against cross-border crimes (smuggling, drug trafficking) and environmental offences.

A recent bill submitted to the National Congress through Presidential Message No. 988 of December 7, 2009, proposed deeper changes to LC 97. Once approved by the Congress it was enacted by the President on August 25, 2010, and became Complementary Law No. 136.

In addition to changing the procedures for military commander selection, now appointed by the Minister

of Defence --formerly designed by the President after listening to the Minister of Defence-- other significant changes can be observed. First, military doctrine has changed, from combined to a single joint command. Second, the armed forces proposed budget will be, from now on, developed jointly with the Ministry of Defence. There is also evidence of the intention to create a Defence Product Secretariat which will be in charge of acquiring military equipment for all three Military Commands. Third, the Air Force and the Navy have been vested with similar policing and repression powers as those conferred upon the Army in 2004. Finally, a unifying instance for all three Commands has been created, the Joint Staff of the Armed Forces, so that the deployment of each Force may be discussed jointly. The Joint Staff will, therefore, have a more important role than that which used to have the Joint Staff for the Defence, considered rather inactive as compared with military Commands.

A number of conclusions can be drawn from all the proposals: on the one hand, the improvement of capabilities for armed forces' actions as a whole. On the other hand, a larger role of civilian power can be seen for the definition and implementation of the national defence policy, which has ceased to be a prerogative exercised by military echelons only.

The Brazilian policy in the defence area has been fast to move. Unifying efforts made along different lines, Brazil has sought to strengthen itself to show the world that, aside from its economic potential and political influence, it will also have reasonable military conditions to defend its own interests and see to it that its demands as an aspiring protagonist in the world scenario are duly heard.

In addition to these changes, another element is worth of note in the new law: the White Book on National Defence. As a matter of fact, a bill addressing this issue and introduced by Representative Jungman was already going through the pertinent formalities in Congress. The White Book will have to contain strategic and budgetary data and other information, including the strategic scenario, the national defence policy and strategy, the modernization of the armed forces, the streamlining and adaptation of defence structures, the economic support, in addition to the pertinent references to peace operations and humanitarian aid. Beginning in 2012, every four years, the Executive Branch will have to send it, duly updated, to the National Congress. As from now, subordination of the defence policy to Congress clearly demonstrates the responsibility of civilian power on defence policy-making.



# Chile

## The Legal Framework and the Defence System

### National Legislation

#### Systems and Concepts

- Act which creates the Superior Council of National Defence (N° 7.144 - 1942/01/05. Last amendment: 1959/04/06)
- Act which dictates Regulations on Mobilization (N° 18.953 - 1990/03/09)
- Act on the National Intelligence System; creates the National Intelligence Agency (N° 19.974 - 2004/10/02)
- Ministry of National Defence Organization Statute (N° 20.424 - 2010/02/04)

#### Military Organization\*

- Code of Military Justice (Decree-Law N° 806 - 1925/12/23. Last amendment: Act N° 20.357 - 2009/07/18)
- Reserved Copper Law (N° 13.196 - 1958/01/01)
- Act authorizing the President of the Republic the disposition of State-owned Lands and Real Estate used by the Armed Forces (N° 17.174 - 1969/08/21. Last amendment: DL N° 1.195 - 1975/11/01)
- Act on Rules for the Execution of Works designated for Exclusive Military Use (N° 17.502 - 1971/11/12)
- Decree-Law on the Recruiting and Mobilization of the Armed Forces (N° 2.306 - 1978/09/12. Last amendment: Law N° 20.045 - 2005/03/10)
- Decree Law of the Military Public Ministry (N° 3.425 - 1980/06/14)
- Decree which establishes Regulations on the Constitution, Mission, Dependency and Responsibilities of the Armed Forces (DS N° 272 - 1985/03/16)
- Act on National Defence Staff Pension System (N° 18.458 - 1985/11/11. Last amendment: Act N° 20.369 - 2009/09/17)
- Act for Armed Forces' Social Welfare Service Statute (N° 18.712 - 1988/06/04)
- Act establishing the Authority of the Army Military Industry and Engineering Command (N° 18.723 - 1988/07/12)
- Constitutional Organic Act of the Armed Forces (N° 18.948 - 1990/02/27. Last amendment: Act N° 20.424 - 2010/02/04)
- Act of the Armed Forces Health System (N° 19.465 - 1996/08/02)
- Decree with force of law which establishes Armed Forces Staff's Statute (DFL N° 1 - 1997/10/27. Last amendment: DFL N° 1 - 2009/05/12)
- Act which modernizes the Mandatory Military Service (N° 20.045 - 2005/09/10)
- Act on Staff and Professional Troops for the Armed Forces (N° 20.303 - 2008/12/04)
- Act which amends Act N° 19.067 and sets out Rules for Chilean Troops to take part in Peace Operations (N° 20.297 - 2008/12/13)
- Act of War Crimes and Crimes against Humanity (N° 20.357 - 2009/07/18)

- Advisory and assistance functional relationship
- Command reporting line
- - - - Joint planning and management relationship

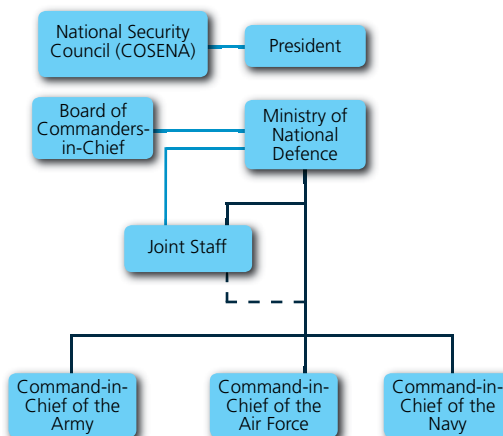

The President may request the advice of the National Security Council, which is composed of the Chairmen of the Senate, the House of Representatives and the Supreme Court, the Commanders-in-Chief of the Armed Forces, the General Director of Carabineros and the General Comptroller of the Republic. The Armed Forces are under the Ministry of Defence. The Minister is advised by the Board of Commanders in Chief, composed of the Chairman of the Joint Chiefs of Staff and the Commanders of the Armed Forces, and the Joint Staff, responsible for the joint preparation and employment of the Armed Forces. The Congress holds the powers granted by the Constitution and permanently monitors defence related issues through the Defence Committees in both Houses.

Source: Compilation based on the Political Constitution, *Ley del Estatuto Orgánico del Ministerio de Defensa Nacional* (N° 20.424 - 2010/02/04) and *Libro de la Defensa Nacional*, 2010.

\* A military justice code reform was passed by Congress. By the closing of this edition, the law was sent to the President for its enactment.

Source: Compilation based on the legislation above mentioned. For constitutional provisions see Chapter 1.

## The Budget

Year	Defence Budget (in US\$)	Government Budget (in US\$)	GDP (in US\$)
2006	3,177,404,842	25,967,436,886	107,703,000,000
2007	4,276,790,277	38,367,602,309	160,784,000,000
2008	4,459,645,809	37,017,804,099	169,919,000,000
2009	4,353,450,717	46,105,933,786	150,361,000,000
2010	4,778,329,754	50,953,560,313	196,451,000,000

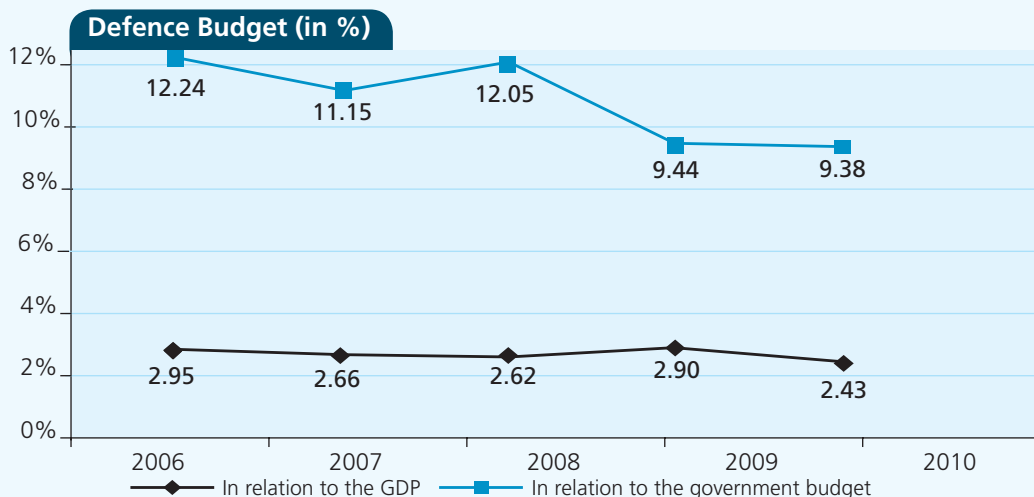

### Defence Budget Breakdown

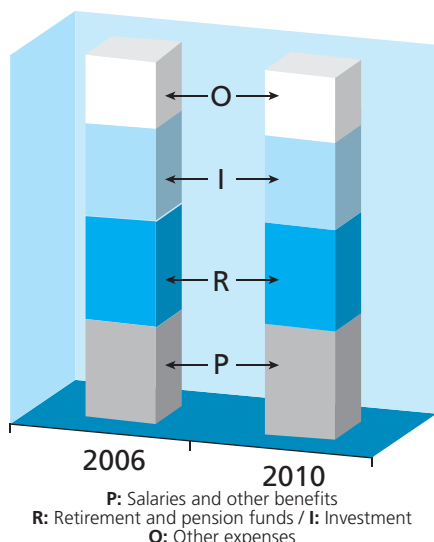

### Comparative Increase (% variation 2006-2010)

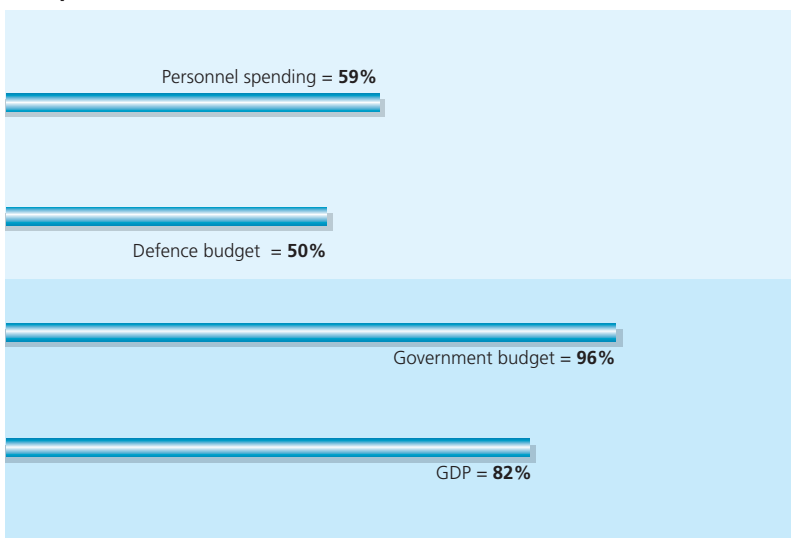

### Defence Budget 2010 (in Local Currency)

Items	Personnel*	Consumer Goods and Services	Other**	TOTAL
<b>Ministry of Defence</b>				
Army of Chile	315,803,208,030	66,692,330,620	10,320,882,470	392,816,421,120
Undersecretary of War	3,151,729,950	3,131,937,990	19,981,083,220	26,264,751,160
Health Organizations	25,864,018,000	14,906,724,000	5,400,586,000	46,171,328,000
Military Industry Organizations	1,780,176,000	751,958,000	339,993,000	2,872,127,000
Navy of Chile	206,283,565,080	89,758,991,710	7,821,966,350	303,864,523,140
Undersecretary of the Navy	749,834,000	309,087,000	13,386,000	1,072,307,000
General Directorate of Maritime Territory	10,957,952,000	25,287,978,000	10,990,726,000	47,236,656,000
Directorate of Health Services	17,023,065,000	26,424,008,000	5,413,504,000	48,860,577,000
Air Force of Chile (FACH)	126,784,211,460	54,877,367,380	4,925,333,800	186,586,912,640
Undersecretary of Aviation	1,230,683,000	427,151,000	21,737,000	1,679,571,000
General Directorate of National Mobilization	964,277,000	1,370,535,000	1,408,624,000	3,743,436,000
FACH Health Organisms	8,589,503,000	9,297,270,000	1,746,850,000	19,633,623,000
Ministry of Defence Administrative Directorate	1,009,226,000	402,173,000	31,590,000	1,442,989,000
Military Geographic Institute	1,780,512,000	1,305,322,000	374,142,000	3,459,976,000
Hydrography and Oceanography Service of the Navy	1,651,916,000	1,535,420,000	370,049,000	3,557,385,000
General Directorate of Civil Aviation	50,872,144,000	17,829,574,000	35,969,560,000	104,671,278,000
FACH Aerophotogrametric Service	655,951,000	757,771,000	587,866,000	2,001,588,000
<b>Ministry of Labour and Social Services</b>				
Retirement Funds National Defence (Capredena)	698,214,895,000	2,949,663,000	98,830,602,000	799,995,160,000
Subtotal	1,473,366,866,520	318,015,261,700	204,548,480,840	1,995,930,609,060
<b>Extra-budgetary funds</b>				
Codelco-Reserved Copper Law***				528,461,000,000
<b>TOTAL</b>				<b>2,524,391,609,060</b>

\* Includes supply of social services.

\*\* Current and capital transfers, tax payments, other current expenses, acquisition of financial and non-financial assets, investment initiatives, loans, debt service and cash final balance. CAPREDENA's acquisition of financial assets and loans are not considered.

### Composition of Defence Budget 2010

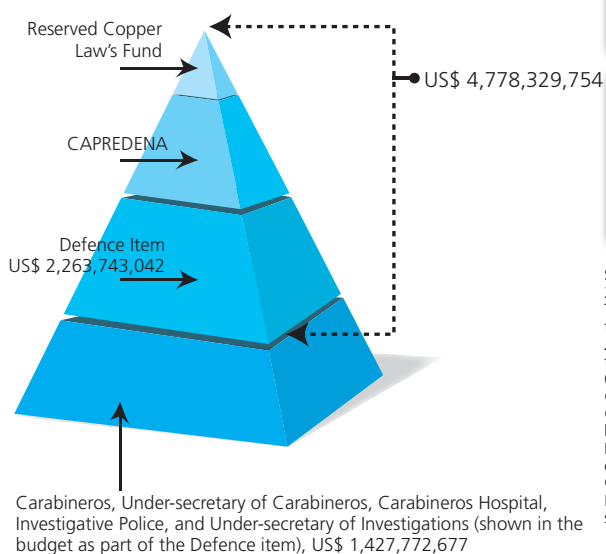

As a contribution for the country's reconstruction process, in 2010 and 2011 a total of 600 million dollars shall be transferred by the Reserved Copper Law's Fund, in addition to 520 million dollars to fund the repair of military facilities damaged by the past earthquake.

Between 2007 and 2009, contracts for military acquisitions and upgrades signed with countries of the European Union (Germany, Austria, Denmark, Spain, Finland, France, the Netherlands, Italy, Norway, Sweden, Switzerland, United Kingdom and the Czech Republic) totalled US\$ 786,500,000 and US\$ 279,866,789 with the United States. That amount represents 30% of the Funds for copper sales in 2007, 2008 and 2009.

**Source:** Compilation based on *Ley de presupuesto del sector público para el año 2006, 2007, 2008, 2009 and 2010*. The State Budget passed by the Congress by means of the above mentioned Act is considered herein. The concept of investment is that expressed in "Acquisition of non-financial assets" and "Investment initiatives", and revenues for the copper fund. Extra-budgetary funds: *Estadísticas de las Finanzas Públicas 2000-2009*. Budget Directorate, Ministry of Economy of the Republic of Chile. Acquisitions: reports submitted by the member States in accordance with the Common Position 2008/944/PESC of the European Union Council (reports issued as of October, 2010) and Just the Facts (Center for International Policy, Latin American Working Group Education Fund and Washington Office on Latin America). GDP: Projection of the World Economic Outlook Database, IMF, of each year under review. This source has been taken for comparative purposes. Each country prepares the budget based on its own GDP estimation. In the case of tables expressed in national currency for the budget amounts expressed in dollars, an average exchange rate of 525.51 as of July has been used; this rate was calculated based on figures provided by the Central Bank of Chile. Expressions in Bold Type (Table) make reference to the various defence budget items, which can be found in a sector-based or institutional classification of the Budget Act.



**The Ministry of National Defence**

**Responsibility:**

The Ministry of National Defence is the highest body in assisting the President in its government and administration functions of national defence. (*Ley del Estatuto Orgánico del Ministerio de Defensa Nacional*, N° 20.424 – 2010/02/04, Sec. 3)

**Organization Chart**

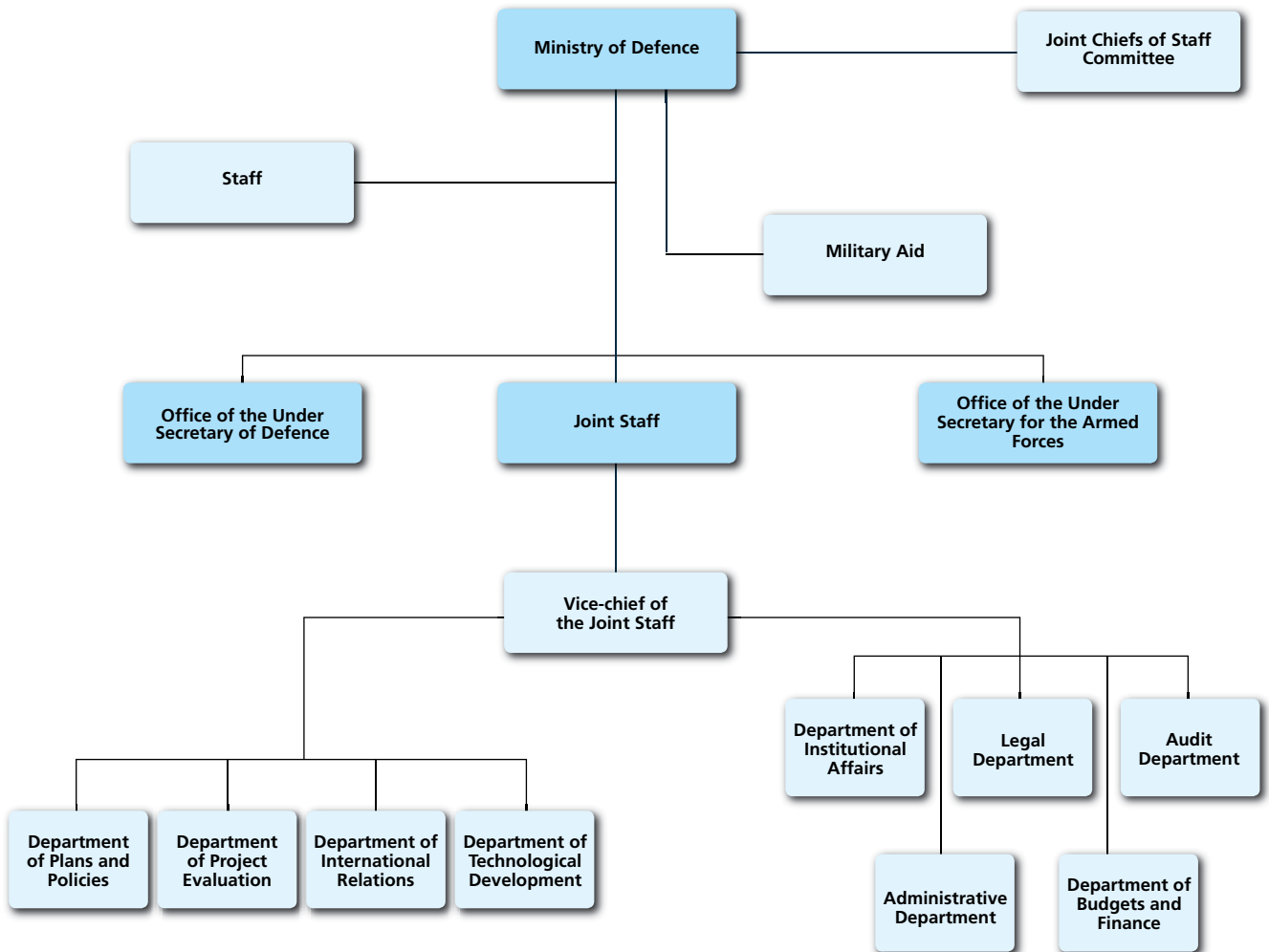

<b>Date of Foundation:</b> 1932
<b>Current Minister (September 2010):</b> Jaime Ravinet de la Fuente
<b>Can military members be Ministers of Defence?:</b> Yes (if they have retired)
<b>Number of military members who were Ministers of Defence:</b> 18
<b>Number of civilians who were Ministers of Defence:</b> 31
<b>Have there been any women in charge of the Ministry of Defence?:</b> Yes (Michelle Bachelet, 2002-2004 and Vivianne Blanlot, 2006-2007)
<b>Average permanence in the Minister of Defence position:</b> 1 year and 7 months

[The Minister currently in charge is not considered. The creation date is related to the moment in which the term "Defence" becomes part of the Institution's name]

**Source:** Compilation based on information provided by the Ministry of National Defence. As this work was going to press, the personnel corresponding to the new structure determined by the law passed in 2010 is being defined.

**Political Definitions**

**Policy Guidelines**

- Chile's Defence Policy is framed within the following general State principles:
- The Chilean State nurtures no aggressive purposes against any of the world's nations, nor does it have any territorial claims against its neighbours.
- Its desire is to protect its citizens, defend national interests, and safeguard its political independence, national sovereignty and territorial integrity.
- It has the responsibility to maintain sufficient military capacity to help attain the country's interests and goals, carefully ensuring that such military capability is proportional to the development of the other country's capacities.
- It has the right and the responsibility to use all national resources, particularly its warfare power, if necessary, to defend the country and safeguard national interests in countering external threats.
- The State must promote citizen commitment to national defence, considering, among other objectives, the necessary requirements of mandatory military service, fulfillment of national mobilization demands and needs for sustaining reserve capabilities and abilities.
- For the Chilean State –as well as for all States in general–, its relative geographic situation continues to be a major factor in the formulation of its defence policy.
- It frames its defence policy entirely within the institutional legal framework in effect in the country, and recognizes and honours all treaties and international agreements that fall under such framework, so that its defence policy bears the legitimacy of all State policies, and is representative of the political commitment that binds the State to its citizens and the international community.
- For the Chilean State, it is especially important and convenient to maintain a close and coordinated relationship between its defence and foreign policies, by complementing and enhancing each other, though the defence policy should actually act in support of the latter.
- The State maintains its commitment to contribute to defence and promote international peace, in line with national interests.

**Doctrinarian Principles (Highlights):**

- Chile's defence will be mainly supported by its own national power, without prejudice to its adherence to security/defence alliances or coalitions.
- In cases in which Chile uses its force, whether unilaterally or by integrating a multilateral action, it shall respect the United Nations Charter and be governed by International Humanitarian Law, ensuring the respect of human rights of all the people.
- The National Defence will also cooperate to maintain international peace and stability by participating in multinational operations, according to the national interest.

**2010-2014 Objectives**

- To design an efficient and flexible defence system. In the long term,
  - A national defence system comparable, in terms of efficiency, to that of developed countries similar to Chile in size and strategic challenges.
  - An active involvement of the Chilean society with the Armed Forces in order to strengthen the relation between the civil society and the national defence institutions.

**2010-2014 Topics and Measures**

- To carry on with the modernization of the Armed Forces. The promotion of the modernization process shall continue in terms of material and equipment renovation and structure and deployment.
- To go on with the defence industry renovation.
- Research and development. The association of the Armed Forces with private and public entities shall be promoted for the development of scientific and technological research.
- To submit the bill on health care of the Carabineros and the Investigation Police.
- To propose the Strategy of Security and National Defence.
- To generate a permanent and close relation between the Ministry of Defence and the Ministry of Foreign Affairs.
- To continue the recovery and rebuilding of the infrastructure damaged by the disaster occurred on February 27th, 2010.

Source: *Libro de la Defensa Nacional de Chile*, 2010 and *Cuenta Pública* 2010.

Chile published the *Libro de la Defensa Nacional* (Book of National Defence) in 1997, 2002 and 2010.

**Reports Submitted to the United Nations and the OAS**

1997	1998	1999	2000	2001	2002	2003	2004	2005	2006	2007	2008	2009
✘	✘	✘	✘	✘	✘	✘	✘	✘	✘	✘	✘	✘
		◊		◊	◊		◊	◊	◊			
☛		☛			☛			☛	☛	☛	☛	☛

Register of Conventional Arms: ✘ Register of Military Expenditures: ◊ Implementation of Confidence and Security Building Measures: ☛

Source: Compilation based on reports submitted to the United Nations Register of Conventional Arms and the United Nations Instrument for Reporting Military Expenditures and reports submitted to the OAS on the Implementation of Confidence and Security-Building Measures.



**Military Career**

**Commissioned Officers' Career Path <sup>1</sup>**

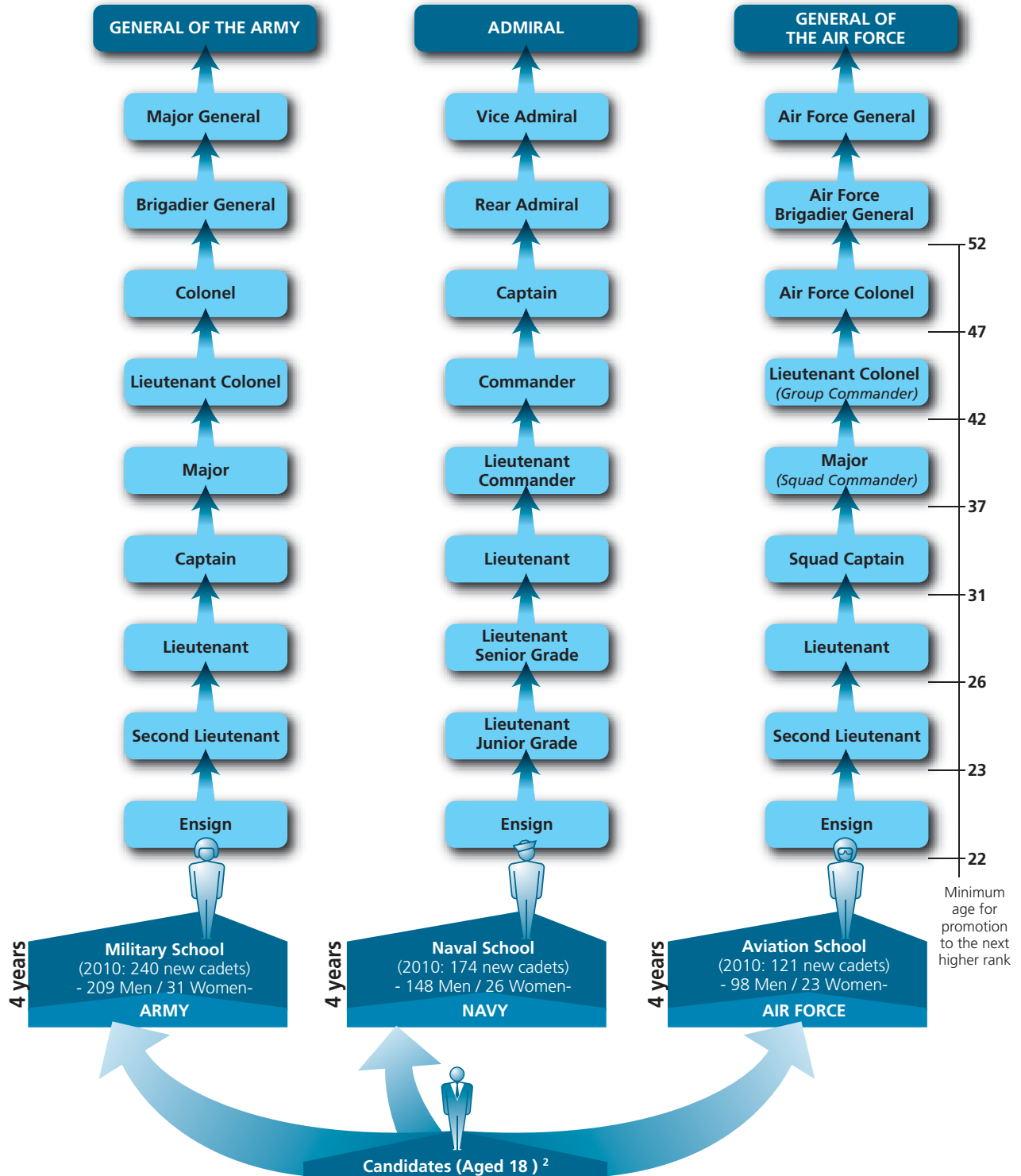

<sup>1</sup> Command corps includes officers who have been educated at military academies from the beginning of their professional careers. The graph makes a theoretical reconstruction of officers' promotion through the completion of mandatory courses. Further requirements for promotion have not been considered.

<sup>2</sup> The age of 18 has been considered for comparative purposes. Entry age varies depending on the services: Army up to 22 years old, Naval Force up to 21 years and 6 months, and the Air Force from 17 to 23 years of age.

**Source:** Compilation based on *Ley orgánica constitucional de las Fuerzas Armadas* (N° 18.948 – 1990/02/27. Last amendment: Law N° 20.424 – 2010/02/04). New cadets: Information provided by the Ministry of National Defence.

**The Armed Forces**

**General Mission**

The Armed Forces' fundamental mission is the defence of the Motherland; they are essential for national security. The safeguard of public order during elections and plebiscites shall also be their responsibility. (Constitution, Sec. 101 and 18)  
 The general mission of the Armed Forces is to contribute to maintaining national sovereignty and territorial integrity, as well as to protect the people, institutions and vital interests of the country in the face of any threat or external pressures. They shall also cooperate with the military forces of other countries in bilateral or multilateral initiatives, always in line with the national interest. (Libro de la Defensa Nacional, 2010)

**Specific Missions**

**Army**

The rationale of the Army is to contribute in a substantial manner to preserving peace. Its main mission is to ensure national sovereignty, maintain the territorial integrity and protect the people, institutions and vital resources of the country, in the face of any external threat or aggression, as well as to become an important tool of Chile's foreign policy. It participates and contributes in many ways and varied intensity in international security and cooperation according to the national interest in compliance with international treaties.

**Navy**

Its mission is to contribute to safeguarding the national sovereignty and territorial integrity, maintain security of the Nation, promote national development and support national interests abroad.

**Air Force**

The mission of the Air Force is to defend the country through the control and use of the air space, the participation in surface warfare and support to the national and friendly forces. Likewise, in times of peace, it fulfils cooperation activities to support the national development, international projection, cooperation to deterrence, among others.

**Total Strength: 61,851**



Officers:	
M 3,463	362 W
Non-commissioned Officers:	
M 15,918	1,015 W
Troops:	
M 13,319	1,474 W
M 91.98%	8.02% W
<b>Total 35,551</b>	



Officers:	
M 2,195	16 W
Non-commissioned Officers:	
M 14,417	1,117 W
Troops:	
H 620	0 W
M 93.83%	6.17% W
<b>Total 18,365</b>	



Officers:	
M 1,070	95 W
Non-commissioned Officers:	
M 5,990	192 W
Troops:	
H 588	0 W
M 96.38%	3.62% W
<b>Total 7,935</b>	

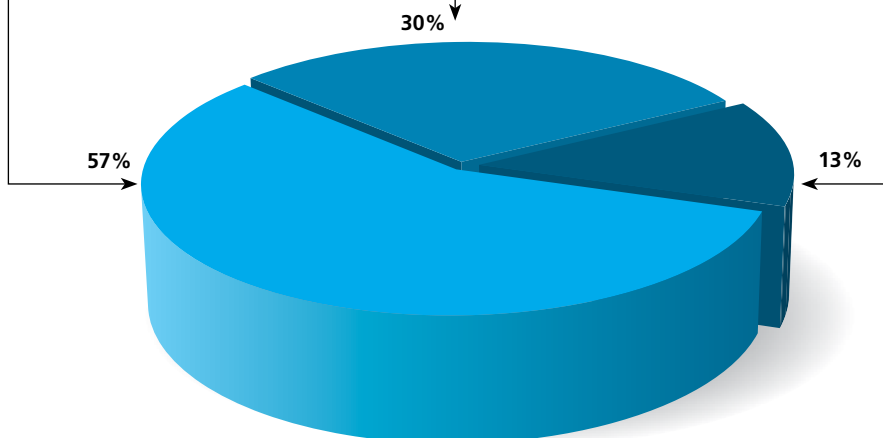

M: Men / W: Women

Source: Libro de la Defensa Nacional, 2010 (missions) and information provided by the Ministry of National Defence (Regular Forces).





**Women in the Armed Forces**

**Women's Admission to the Armed Forces (year)**

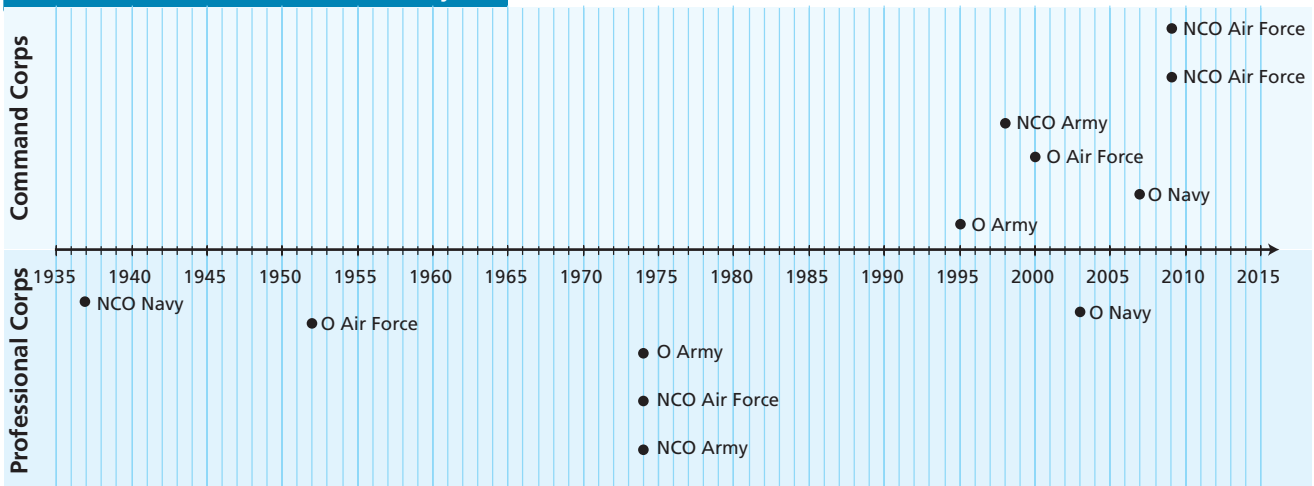

O: Officers - NCO: Non-commissioned Officers

**Note:** The Command corps includes officers who have been educated at military academies from the beginning of their professional careers. The Professional corps refers to those who develop a career in the civilian sphere and are then incorporated to the armed forces.

**Women Officers who have reached the highest rank in the Command Corps (2010)**

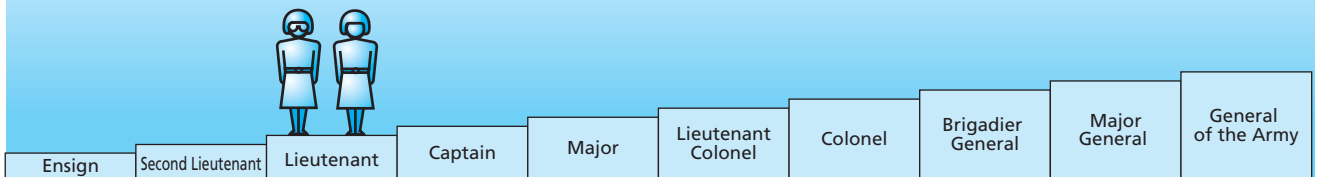

**Note:** These ranks correspond to the Army, as an example. The equivalent rank for Lieutenant in the Air Force is the same. The Navy's first women officers are currently in their 4th year of instruction. They will graduate as Ensigns in January 2011.

**6.91 % (4,271) of the total Armed Forces are women.**

**Source:** Compilation based on information provided by the Ministry of National Defence and Project 07-184 Global Peace and Security Fund-Resdal.

**Military Service**

Military service is mandatory for a maximum of two years. Women may enter the service voluntarily.

	Candidates		Conscripts	
	Men	Women	Men	Women
Army	24,766	7,531	12,408	1,200
Navy	2,354		760	
Air Force	1,929		520	
<b>Total</b>	<b>29,049</b>	<b>7,531</b>	<b>13,688</b>	<b>1,200</b>
	<b>36,580</b>		<b>14,888</b>	

Professional Troops comprise young soldiers from the Military Service as well as Reservists, who are admitted into the institution with the rank of Private, for a non-extended period of 5 years, to serve in different military units of the Army.

At the end of the third year, they may choose to enter the NCO School, taking up a special training course and graduate the following year as Army Class.

Number of Professional Soldiers of the Armed Forces (2010)		
	Men	Women
Army	3,439	264
Air Force	38	-

In the Chilean Army, all conscript soldiers may continue and complete their studies through adult education and technical-professional education programs. Work training courses are also provided.

The following table shows the estimated percentage of soldiers registered in the different programs:

Year	2003	2004	2005	2006	2007	2008	2009
Education	53%	59%	59%	58%	61%	62%	61%
Work Training	27%	27%	32%	30%	33%	33%	29%

**Source:** Information provided by the Ministry of National Defence and *Reporte de Responsabilidad Social del Ejército de Chile* 2008-2009.

## Defence and National and International Community

### Participation in Peace Operations

Missions	Military Component			
	EMM		MC	
	Men	Women	Men	Women
MINUSTAH (Haiti)	-	-	495	8
UNFICYP (Cyprus)	-	-	15	-
UNMOGIP (India and Pakistán)	2	-	-	-
UNTSO (Israel and Palestine)	3	-	-	-

MEM: Military experts on mission, including military observers, judge advocates and military liaison officers, among others - MC: Military Contingent.

**Source:** Compilation based on documents from the Department of Peacekeeping Operations of the United Nations. Data as of 31 August 2010.010.

Chile contributes 523 military troops to the United Nations peacekeeping missions, which represents 6.84% of the total contribution of Latin America.

The Chilean Joint Peacekeeping Operations Centre, CECOPAC, was created on July 15, 2002.

In 2009, 1,476 service members and civilians were trained in peacekeeping operations.



In 2003, on invitation of the British government, Chile started participating in EUFOR, a European Union military force with presence in Bosnia Herzegovina. This Force monitors compliance with Dayton agreements. The Chilean Army has a 21 troop contingent that is currently operating with the Dutch Army.

### National Action Plan on Resolution 1325

A National Action Plan has been developed for the implementation of this UN Resolution. This initiative is coordinated by the Ministry of Defence, in cooperation with the Ministry of Foreign Affairs and the National Women's Service, and performs cross-functional activities including military, law-enforcement and civil society dimensions. Chile is the first Latin American country to create an action plan for women's security and protection in case of armed conflict. Committed objectives and actions:

#### Gender Approach

Promote incorporation of gender perspective in the understanding and approach of processes for the prevention of conflicts, conflictive situations and post-conflicts.

#### Rights Approach

Respect, ensure and protect women's and girls' rights in conflict and post-conflict situations.

#### Coordination

Strengthen coordination efforts developed at the international and interagency levels, as well as with the civil society.

**Source:** *Libro de la Defensa Nacional, 2010* and *Plan de Acción Nacional para la Implementación de la Resolución del Consejo de Seguridad de la Organización de Naciones Unidas 1325/2000*.

### Assistance in Natural Disasters

The earthquake and seaquake at the beginning of 2010 made the Armed Forces deploy their means, and collaborate in reconstruction tasks in the most affected areas of the country, apart from setting new challenges in the face of disaster scenarios.

- The Navy has performed cleaning tasks and debris removal; transport of basic goods and has collaborated in reconstruction works, apart from having created a new communication system to coordinate actions in the case of a critical event.
- 10,000 troops of the Army make up a Humanitarian Support Force to carry out different tasks to mitigate the effect of disasters.
- The Air Force made recognition flights, provided support to the authorities and transportation of campaign hospitals, injured persons and emergency staff, and also distributed and transported humanitarian aid. The "Familia a Familia" programme was established, consisting in sponsoring family groups from Lolo, an area strongly affected by the earthquake.

### Disaster Support and Rescue Regular Activities

#### Navy

- Tsunami alert. The Hydrographic and Oceanographic Service of the Chilean Navy (SHOA) monitors the Pacific ocean on a permanent basis.
- Creation of the Fire Prevention Brigade (BRIPRIN) to prevent and extinguish fires.
- Search and rescue. During 2008, the Navy successfully rescued more than 2,000 persons in maritime distress events and 500 on beaches.

#### Army

- Emergency Units (UFEs). 54 units with approx. 100 men each.
- 1,012 community support missions carried out in 2009.
- Forest Fire Brigades of the Chilean Army (BRIFEs). 47 brigades with 25 men each.
- 3,096 members of the Army provided support in 74 CONAF's missions in 2009.
- Platoons and Mountain Emergency and Rescue Patrols of the Army (PARMEs). There are 9 PARMEs, each comprised of 3 patrols with 7 crewmen each.

#### Air Force

- Establishment of air bridges and transfer of people in disasters.
- Air Search and Rescue (SAR). A Rescue Coordination Centre was created in each Air Brigade to coordinate and conduct operations.

### Support Actions

#### Health

- Military Field Hospital of the Army (185 surgeries, 243 tests, 382 dental works).
- Disabled Rehabilitation in the Army's equestrian centres (534 patients.)
- Army's Patrol "Cirujano Videla", monthly medical-dental assistance activities in isolated areas of the X and XI regions.
- The Armed Force carries out medical-dental operations on Easter Island since 1995. Currently, they provide free care to about 80% of the population.
- The Air Force cooperates with "Corporación de Fomento del Trasplante" in organ transport services.

#### Infrastructure

- Road works (11 projects, equal to 73.10 km.)
- Harbour work (infrastructure improvement, investment in Edén Port US\$ 1,476,435).
- Airport works (airfield construction in remote areas, Juan Fernández investment US\$ 2,908,652).
- Connectivity with isolated areas (Navy)

#### Promotion of Development

- Agricultural development training courses of the Army in Rapa Nui.
- Army's participation in the National Action Plan of Equine Promotion.
- Army and Navy participation in the programme "Un techo para Chile" (A home for Chile) (transport and assembly of emergency housing).
- Air Force, delivery of food to people and of cattle fodder in remote areas.
- Transfer by the Air Force of children and young people from Rapa Nui, Juan Fernández, of the X and XI regions, to school.

In 2008, the Policy of Corporate Social Responsibility of the Ministry of Defence was created with the aim of providing guidance and a framework for all institutional actions contributing to the country's sustainable development.

**Source:** *Libro Blanco de la Defensa Nacional, 2010, Reporte de responsabilidad social del Ejército 2008 - 2009* and websites of the Armed Forces.



## Analysis:

# National Defence and the February 27 Earthquake

## Miguel Navarro Meza

*Professor of the National Academy of Political and Strategic Studies (ANEPE).*

For a number of reasons, some of them easy to understand and other less evident, national defence was –and still is—deeply involved with the earth- and sea-quakes that affected Chile’s Central-Southern area last February 27. As a matter of fact, political authorities’ tardiness in declaring a state of emergency and the consequent delay in recovering public order, severely affected in the disaster area, initially led public opinion to focus on the armed forces and defence in general.

The same happened with the alleged delay in armed forces’ response over the first moments after the calamity, of which in fact they cannot be blamed; as according to Chilean law, they must wait for orders before taking any action, except in very specific situations. On the other hand, the armed forces themselves were directly affected by the earthquake and tsunami, which caused severe damage to their infrastructure. This was especially noticeable at the Talcahuano Naval Base and the ASMAR shipyard, both strongly hit by the seaquake.

From a broad perspective and after several months, three main areas can be identified relating to national defence, the armed forces and the Feb-27 events, including: a) the modernization of armed forces employment upon disaster occurrence; b) the Copper Act System, since part of its resources shall be allocated to the re-

covery of military capabilities and infrastructure repair; and c) the direct involvement of the armed forces, especially the Army, in the reconstruction process.

### Employment of the Armed Forces in Disaster Situations

Most understandably, Chile has a tradition of employing the armed forces at times of disaster, for both restoring and maintaining public order and organizing the provision of assistance and aid at the affected areas. The leading role assumed by the Chilean Navy after the earthquake that hit Valparaíso Port in 1906 is especially remembered. Consequently, military presence at disaster areas is regulated under the Constitution, in the constitutional state of exception defined as state of catastrophe, and in its supplementary legislation.

However, since the Feb-27 events revealed a number of coordination shortcomings, the current Administration is seeking to create greater integration among the armed forces and the corresponding civil organization, the National Emergency Office (ONEMI), which, in turn, is currently subject to a reorganization process. The recent implementation of a Joint Staff under the Defence Ministry Organization Act sanctioned last January, has greatly facilitated this initiative. The idea is to create

a permanent civil-military coordination instance allowing to maintain enhanced military preparedness to these ends and a more expedite integration with the corresponding civil agencies. At the time this paper is being written, the Ministry of Defence is discussing several models for inter-agency civil-military coordination and a decision is expected by the end of this year, in parallel with the reorganization of the above mentioned ONEMI.

It should be noted that Chilean authorities have been careful not to assign the armed forces any work which might be alien to their constitutional missions of defending the homeland and being instrumental to national security. However, the disaster issue is fully integrated to their mission, in a manner that fully agrees with the fulfillment of its main duties.

#### **Defence Capital Raising System: the Copper Act**

The Feb-27 earth and seaquake once again raised the issue of the Copper Act as the defence funding mechanism. As it is well known, this issue has emerged regularly since the early '90s and despite a special rhetoric around it the system has not been altered. Only in the last period of the previous Administration did the Executive submit to lawmakers a bill to change the whole defence funding structure, including capital investment. This bill has remained held up in the House of Representatives since August 2009.

The matter has arisen once again on account of the savings originated from the high international markets copper price. Indeed, the reconstruction financing bill carries a special title that allows using up to US\$1.2 billion from that fund (which otherwise could not be used), partly for the repair of damaged military infrastructure and partly to supply general reconstruction funds. Nonetheless, this process has inevitably recycled the more fundamental debate on defence capital financing system. The current Administration has already announced that it will submit an amendment Bill to Congress by the end of 2010; and during the election campaign, the political program of the incumbent President included the annulment of the current system to be replaced by a pluriannual model which, in fact, is quite similar to the one promoted by the previous Administration.

This is no minor subject and the timing of its discussion is quite complex. While the Feb-27 events placed the capital funding issue in focus, the nation's international context could hinder the debate. The maritime border dispute with Peru, currently under consideration of the International Court of Justice, the legal outcome of which is expected by 2012, and the South Ice Field

issue still pending with Argentina suggest caution in this matter, in both the timing of starting the debate and the solutions to be adopted. The insistence on changing the system is as strong as are the stances that suggest postponing this debate or limiting its effects to a modernization of the current mechanism, owing to the strategic and political advantages this would entail. This has been an indirect consequence of Feb-27 but, it could be one with the largest transcendence to national defence.

#### **The Armed Forces in the Reconstruction Process**

Traditionally, armed forces' participation in disaster situations in Chile has been associated with the restoration and maintenance of public order, transportation and assistance distribution and aid coordination. In the current context, however, after completion of first aid actions, the armed forces, and particularly the Army, have been assigned to reconstruction itself. This is relatively unprecedented; only in the '60s, during the Frei Montalva Administration, under the *Military Developist Model*, were service men assigned to infrastructure repair and construction work. As a consequence of said experience the Army strengthened the *Military Work Corps*, a special organization which dates back to 1953, the purpose of which is to develop projects in extreme situations where there are no interested or qualified private agents to execute them. In all likelihood, their most remarkable work was the construction of the Austral Highway in the '70s and '80s.

In the present situation, the Army has assumed a significant part of the reconstruction process in the areas hit by the quake. To this effect, the Military Work Corps has hired 15,000 civilian workers who report to specialized military personnel. It is worth noting that the large majority of the people hired are women who have seen in this an opportunity to improve their standards of living. All the project is financed through a special fund created by the Executive branch, materializing a form of effective government involvement in the reconstruction process, which otherwise the Army could not undertake on account of constitutional restrictions in this respect. Furthermore, this initiative is in line with the concern for institutional social responsibility demonstrated by the armed forces and, more particularly, the Army.

In sum, the events of Feb-27 have had concrete effects on the defence function and on the armed forces, in terms of strengthening some of its traditional objectives, undertaking new missions even if provisional and, in general, improving their relations with society which on its own –and according to the most recent polls– is quite close and positive.



# Colombia

## National Legislation

### Systems and Concepts

- Decree by which the National Security Council merges with the Superior Council of National Defence and the Commission created by the Decree 813 of 1983 (N° 2.134 - 1992/12/31)
- Act establishing Civil Service Career Rules (N° 443 - 1998/06/11)
- Act by which Benefits are granted to Relatives of People Demised during Mandatory Military Service (N° 447 - 1998/07/21)
- Act on National Agency Organization and Operation Rules (N° 489 - 1998/12/29)
- Act by which the President of the Republic is vested with Extraordinary Authority to issue Rules related to Military Forces and the National Police (N° 578 - 2000/03/15)
- Decree by which the Ministry of National Defence Structure is modified and other Provisions are enacted (N° 1.512 - 2000/08/11)
- Decree modifying the Bylaw which regulates the National Ministry of Defence Civil Personnel Management System (N° 1.792 - 2000/09/14)
- Act by which the Juridical Nature of Nueva Granada Military University is modified (N° 805 - 2003/04/29)
- Act by which Provisions are established to reinstate Members of Illegal Armed Groups (N° 975 - 2005/07/25)
- General Act on Forestry (N° 1.021 - 2006/04/20)
- Act which establishes the Special Administrative System for Civilian Public Employees at the Service of the National Ministry of Defence, for the Military Forces, the National Police and its Decentralised Entities (N° 1.033 - 2006/07/19)
- Act governing the Acquisition of Goods and Services for National Security and Defence (N° 1.089 - 2006/09/01)
- Decree governing Special Career System (N° 091 - 2007/01/17)
- Decree setting out and modifying the Denomination and Classification of Jobs at Defence Agencies (N° 092 - 2007/01/17)
- Decree setting out Basic Wage Scales for Civilian Staff (N° 093 - 2007/01/17)
- Act 1,097 on Confidential Expenses Regulation Decree (N° 1.837 - 2007/05/25)
- Decree by which the Structure of the Ministry of National Defence is partially modified (N° 3.123 - 2007/08/17. Last amendment: Decree N° 4.481 - 2008/11/27)
- Act by which Rules are enacted to strengthen the Legal Frame which allows Intelligence and Counter intelligence Agencies to fulfil their Constitutional and Legal Mission (N° 1.288 - 2009/03/05)

### Military Organization

- Act on Recruiting and Mobilization Service (N° 48 - 1993/03/03)
- Military Criminal Code Act (N° 522 - 1999/08/12)
- Decree which modifies the Decree which regulates the Rules for the Promotion of Officers and Warrant Officers of the Military Forces (N° 1.790 - 2000/09/14. Last amendment: Act N° 1.405 - 2010/07/28)
- Act regulating Issues concerning Disability, Compensations, Disability Pensions and Administrative Reports for Injuries (N° 1.796 - 2000/09/14)
- Act on the Unique Disciplinary Code (N° 734 - 2002/02/05)
- Act which partially modifies the Statute of Promotions of Officers and Warrant Officers of the Military Forces (N° 775 - 2002/12/09)
- Act which Rules over the Armed Forces Disciplinary Regime (N° 836 - 2003/07/16)
- Decree establishing a Disability and Survival Pension System for Armed Forces Professional Soldiers (N° 2.192 - 2004/07/08)
- Act on Rules, Objectives and Criteria to set out the Pension System and Retirement Allowance for Members of the Public Force (N° 923 - 2004/12/30)
- Act of Military Situation of People older than 28 (N° 924 - 2004/12/30)
- Act on Requirements for Positions at Military Penal Jurisdiction (N° 940 - 2005/01/05)
- Act which modifies Decrees related with the Wage System and Benefits (N° 987 - 2005/09/09)
- Act which establishes a Special Procedure in the Criminal Military Code (N° 1.058 - 2006/07/26)
- Decree compiling the Rules of Decree Law 1.790 of 2000 on Career Rules (N° 1.428 - 2007/04/27)

Source: Compilation based on the legislation above mentioned. For constitutional provisions see Chapter 1.

## The Legal Framework and the Defence System

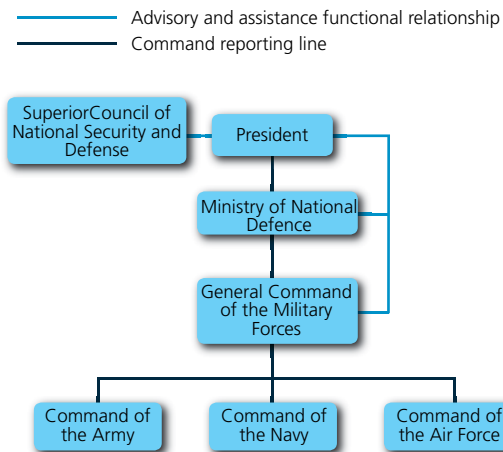

The President is advised by the Superior Council of National Security and Defence, composed of the Ministers of Government and Defence, the General Commander of the Armed Forces, the General Director of the National Police, the Directors of the Administrative Department of the President's Office and of Security, and the Presidential Advisor for National Defence and Security. The command of the military forces is held by the President, who holds it either directly or through the Minister of Defence, and the General Commander, who, in turn, has command over the forces. The Congress holds the powers granted by the Constitution and permanently monitors defence related issues through the specific Committees in both Houses.

Source: Compilation based on *Decreto por el cual se modifica la estructura del Ministerio de Defensa Nacional y se dictan otras disposiciones* (N° 1.512 - 2000/08/11. Last amendment: Decree N° 4.481 - 2008/11/27), and *Decreto por el cual se fusionan el Consejo Nacional de Seguridad, el Consejo Superior de la Defensa Nacional y la Comisión creada por el Decreto 813 de 1983* (N° 2.134 - 1992/12/31).

## The Budget

Year	Defence Budget (in US\$)	Government budget (in US\$)	GDP (in US\$)
2006	2,872,392,573	38,529,560,858	108,461,000,000
2007	4,105,180,855	56,045,533,692	171,738,000,000
2008	6,004,957,107	64,578,637,852	202,437,000,000
2009	5,534,277,720	64,812,772,301	228,614,000,000
2010	6,178,261,917	75,672,628,409	268,107,000,000

### Defence Budget (in %)

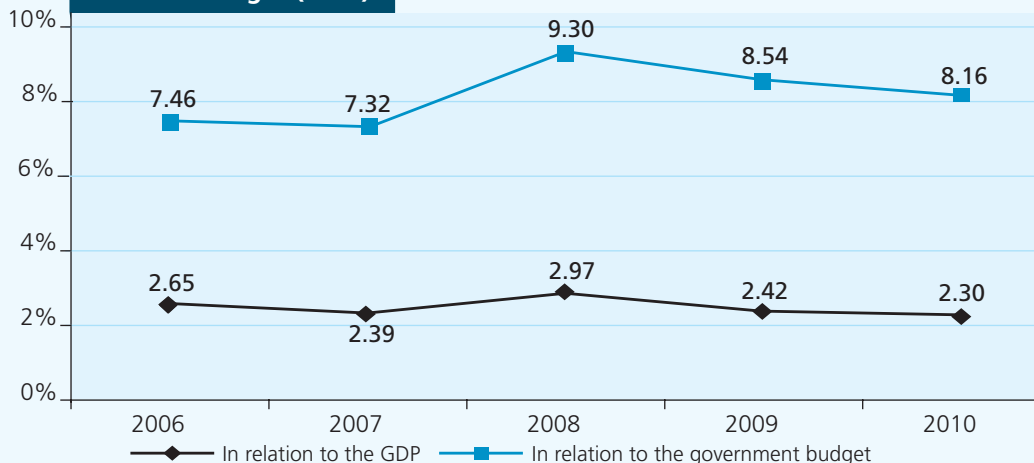

**Defence Budget Breakdown**

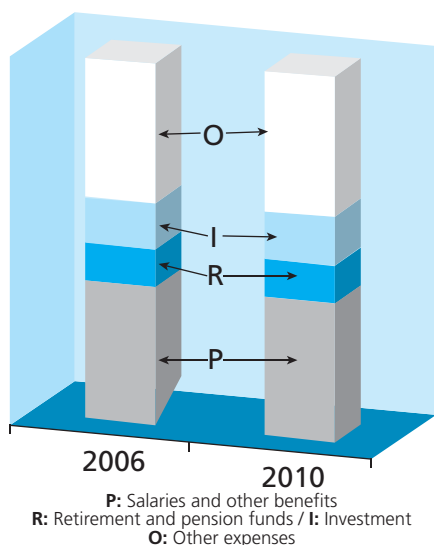

**Comparative Increase (% variation 2006-2010)**

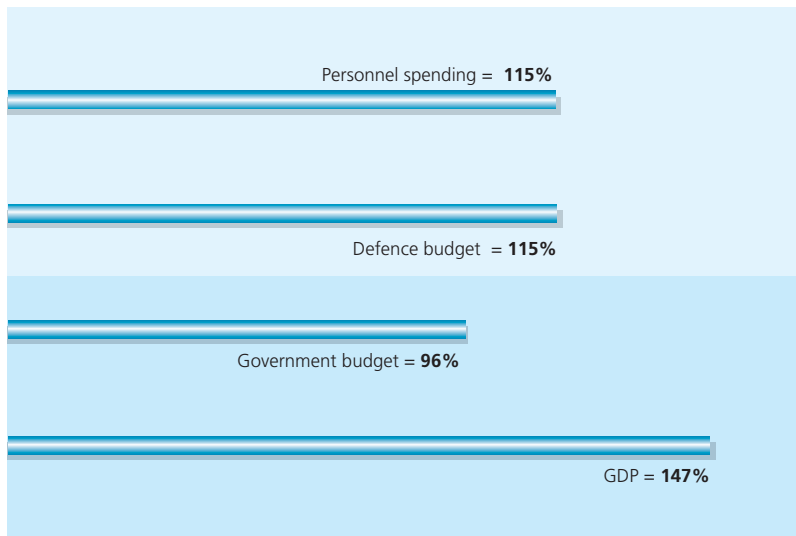

**Defence Budget 2010 (in Local Currency)**

Ministry of Defence section	Personnel	Other Operational Expenses*	Investment	TOTAL
<b>Ministry of Defence</b>				
General Administration	76,740,931,832	1,066,589,863,011	56,730,280,660	1,200,061,075,503
General Command	14,346,617,094	23,703,020,016	30,341,794,749	68,391,431,859
Army	3,473,730,983,871	1,242,935,443,705	548,899,683,047	5,265,566,110,623
Navy	607,072,223,619	270,946,309,655	618,933,400,000	1,496,951,933,274
Air Force	307,067,661,949	559,731,140,978	366,298,330,777	1,233,097,133,704
Health	62,062,378,000	576,078,580,000	11,448,000,000	649,588,958,000
General Maritime Directorate	16,882,477,176	23,533,844,802	9,718,000,000	50,134,321,978
Retirement Fund of the Military Forces	4,637,850,000	1,403,473,810,000	1,500,000,000	1,409,611,660,000
Institute Casas Fiscales of the Army	1,962,500,000	16,906,310,000	13,350,000,000	32,218,810,000
Colombian Civil Defence	5,016,136,000	13,318,422,699	1,992,000,000	20,326,558,699
Officers Military Club	5,715,000,000	23,542,000,000	8,260,000,000	37,517,000,000
Military Hospital	46,793,557,000	123,168,137,000	22,621,000,000	192,582,694,000
Logistics Agency of the Military Forces	9,144,910,000	433,666,150,000	8,434,000,000	451,245,060,000
<b>TOTAL</b>	<b>4,631,173,226,541</b>	<b>5,777,593,031,866</b>	<b>1,698,526,489,233</b>	<b>12,107,292,747,640</b>

\* Includes general expenses, current transfers, capital transfers, sales and production expenses.

**Composition of Defence Budget 2010**

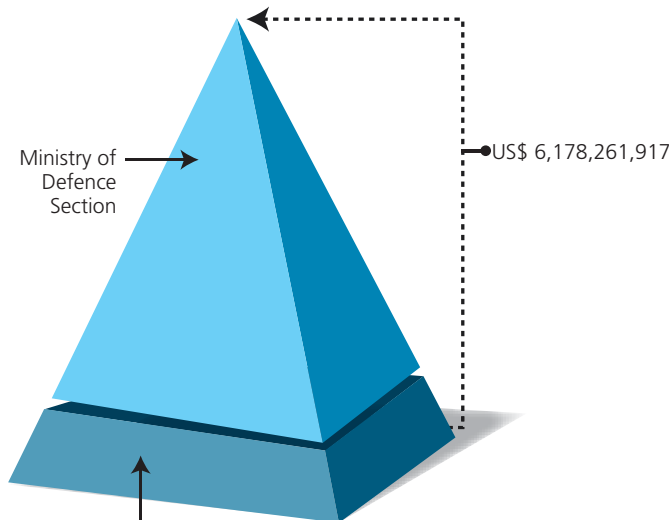

National Police Retirement Fund, Revolving Fund of the Police and Superintendence of Private Protection and Security (shown on Ministry of Defence Section) US\$ 1,064,252,120

Military acquisitions since 2007 reached around US\$ 3,924,000,000. These purchases were made with special funds approved by the National Council for Economic and Social Policy (CONPES). This amount accounts for 18% of the budget allocated to defence for 2007, 2008, 2009 and 2010.

**Source:** Compilation based on *Ley por la cual se decreta el presupuesto de rentas y recursos de capital y Ley de apropiaciones para la vigencia fiscal del 1° de enero al 31 de diciembre de 2006, 2007, 2008, 2009 and 2010*. The National Budget passed by Congress by means of the above mentioned Act is considered herein. The concept of investment is that expressed in "Investment". Acquisitions: *Memorias al Congreso de la República 2008-2009 y 2009-2010*, Ministry of National Defence. GDP: Projection of the World Economic Outlook Database, IMF, for each year under review. This source has been taken for comparative purposes. Each country elaborates the budget based on its own GDP estimation. The dollar value considered corresponds to the exchange rate determined by the World Economic Outlook Database, IMF, for each year under consideration. As of July, the 2010 exchange rate average is 1,937.90 Pesos, based on data provided by the Central Bank of Colombia. For further calculations, figures are provided in local currency. Expressions in Bold Type (Table) make reference to the various defence budget items, which can be found in a sector-based or institutional classification of the Budget Act.



**The Ministry of National Defence**

**Responsibility:**

The Ministry of Defence conducts the Military Forces and the National Police as mandated by the President, formulating and adopting the sector policies, general plans, programmes and projects for the defence of the sovereignty, independence and territorial integrity of the Nation as well as to maintain the constitutional order and guarantee a democratic co-existence. The National Ministry of Defence counts on the direct assistance of the General Commander of the Military Forces, the Commanders of the Armed Forces, the General Director of the National Police and the Vice Minister.

(Decreto por el cual se modifica la estructura del Ministerio de Defensa Nacional y se dictan otras disposiciones, N° 1.512 – 2000/08/11, Sec. 2, 3, 4 and 5)

**Organization Chart and Personnel**

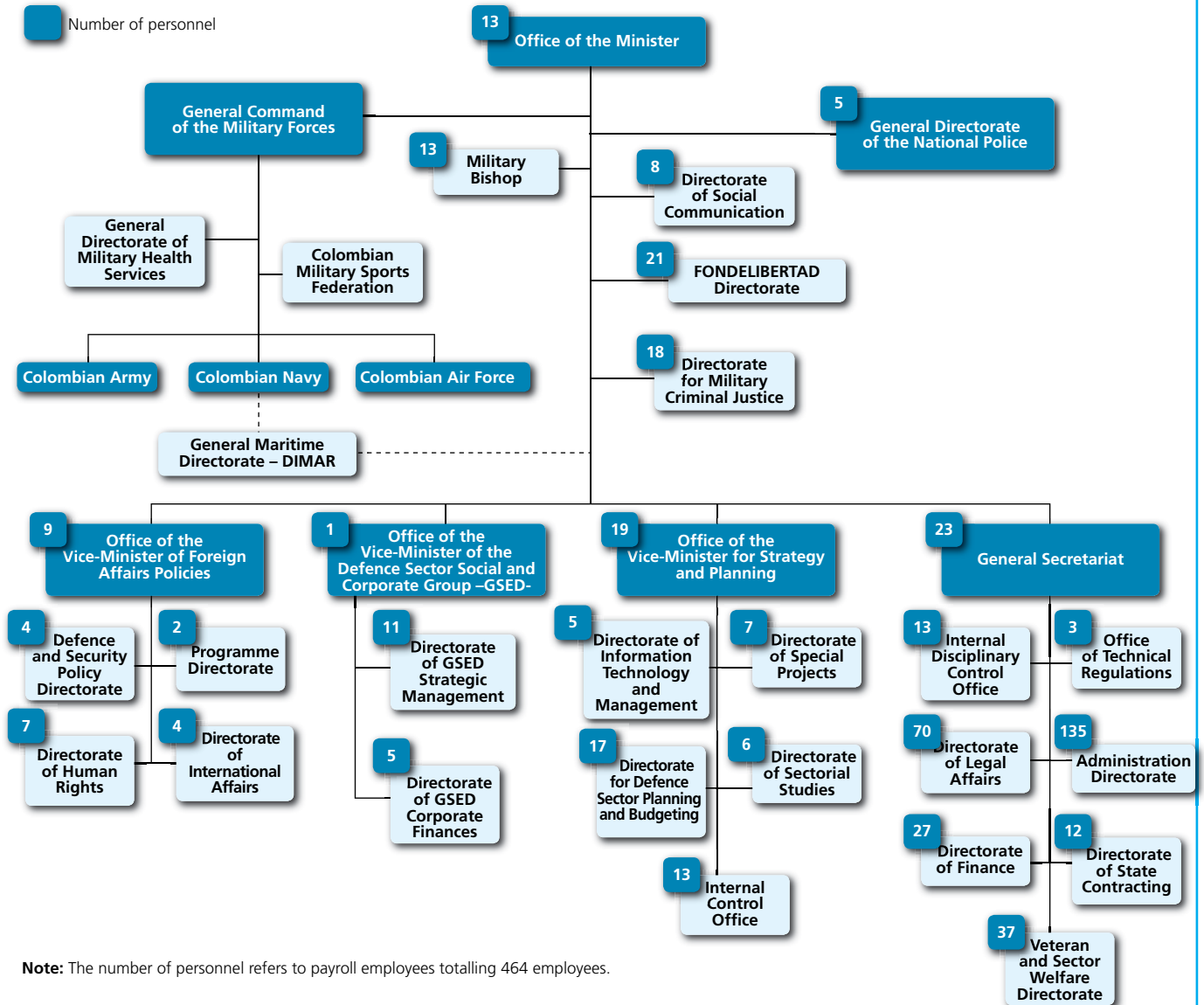

**Note:** The number of personnel refers to payroll employees totalling 464 employees.

<b>Date of Foundation:</b> 1965
<b>Current Minister (September 2010):</b> Rodrigo Rivera Salazar
<b>Can military members be Ministers of Defence?:</b> Yes (if they have retired)
<b>Number of military members who were Ministers of Defence:</b> 12
<b>Number of civilians who were Ministers of Defence:</b> 13
<b>Have there been any women in charge of the Ministry of Defence?:</b> Yes (Marta Lucía Ramírez de Rincón, 2002-2003)
<b>Average permanence in the Minister of Defence position:</b> 1 year and 10 months

[The Minister currently in charge is not considered. The creation date is related to the moment in which the term "Defence" becomes part of the Institution's name]

**Source:** Compilation based on information provided by the Ministry of National Defence.

**Political Definitions**

**Policy Guidelines**

The consolidation of the Nation's territorial control and rule of law is understood as the condition in which security provided by the Public Force can enable the State to fully exercise its authority and allow all its institutions and agencies to operate freely and seamlessly, while enabling the people to fully enjoy their full rights.

**Programs and Actions associated with the National Development Plan:**

1. Territorial control and defence of national sovereignty:
  - Consolidation of the Defence and Democratic Security Policy (PDSD) within the national territory.
  - Maintenance of strategic capabilities.
  - Strengthening of State intelligence.
2. Combat illegal narcotics and organized crime:
  - Consolidation of tasks of crop eradication, interdiction, extradition, money-laundering control and demand reduction.
  - Combat racketeering and kidnapping.
3. Peaceful co-existence and security:
  - Strengthening of levels in charge of policy-making and implementation.
  - Consolidation of the community policing model.
  - Information systems and contrast media.
  - Domestic violence and juvenile crime.
  - Regulatory reforms.

**Strategic Goals**

Consolidate the country's territorial control and strengthen rule of law in the entire national territory. Protect the people, maintaining a strategic initiative against all sorts of threats to citizen security. Dramatically increase the costs for drug trafficking activity in Colombia. Maintain a legitimate, updated and effective Public Force that citizens can trust and rely upon. Sustain the decreasing trend of all crime indicators in the country's urban centres.

**Integral Defence and Security Policy Objectives**

1. Consolidation of security and combat against illegal armed groups: Intensify the combat against these groups, to ensure security conditions that may allow consolidating the rule of law in the entire territory and, thus, lead to prosperity.
2. Counter-narcotics and fight against illegal activities: Combat drug-trafficking and other sources of financing and supply for these gangs, as well as different expressions of cross-border organized crime.
3. Strategic capabilities: Strengthen strategic capacities to ensure national defence and sovereignty.
4. Citizen security and peaceful co-existence: Ensure protection of life and peace for the people, by combating all manifestations of crime and delinquency, while promoting inter-agency coordination and ensuring enhanced levels of peaceful co-existence and prosperity.
5. Modernization of the defence and security sector: Deepen the implementation of security and defence management best practices and innovation, within the proper regulatory framework.

**Source:** *Guía de Planeamiento Estratégico 2007-2010, Logros de la Política Integral de Defensa y Seguridad para la Prosperidad* (September 2010), Ministry of National Defence. The 2011-2014 National Development Plan will be disclosed by the end of 2010.

Colombia published its *Política de Defensa y Seguridad Democrática* (Defence and Democratic Security Policy) in 2003 and *Política de Consolidación de la Seguridad Democrática* (Democratic Security Consolidation Policy) in 2007.

**Reports Submitted to the United Nations and the OAS**

1997	1998	1999	2000	2001	2002	2003	2004	2005	2006	2007	2008	2009
										✘		✘
											◆	◆
							✱		✱			✱

Register of Conventional Arms: ✘ Register of Military Expenditures: ◆ Implementation of Confidence and Security Building Measures: ✱

**Source:** Compilation based on reports submitted to the UN Register of Conventional Arms and the UN Instrument for Reporting Military Expenditures and reports submitted to the OAS on the Implementation of Confidence and Security Buildings Measures.





**Military Career**

**Commissioned Officers' Career Path <sup>1</sup>**

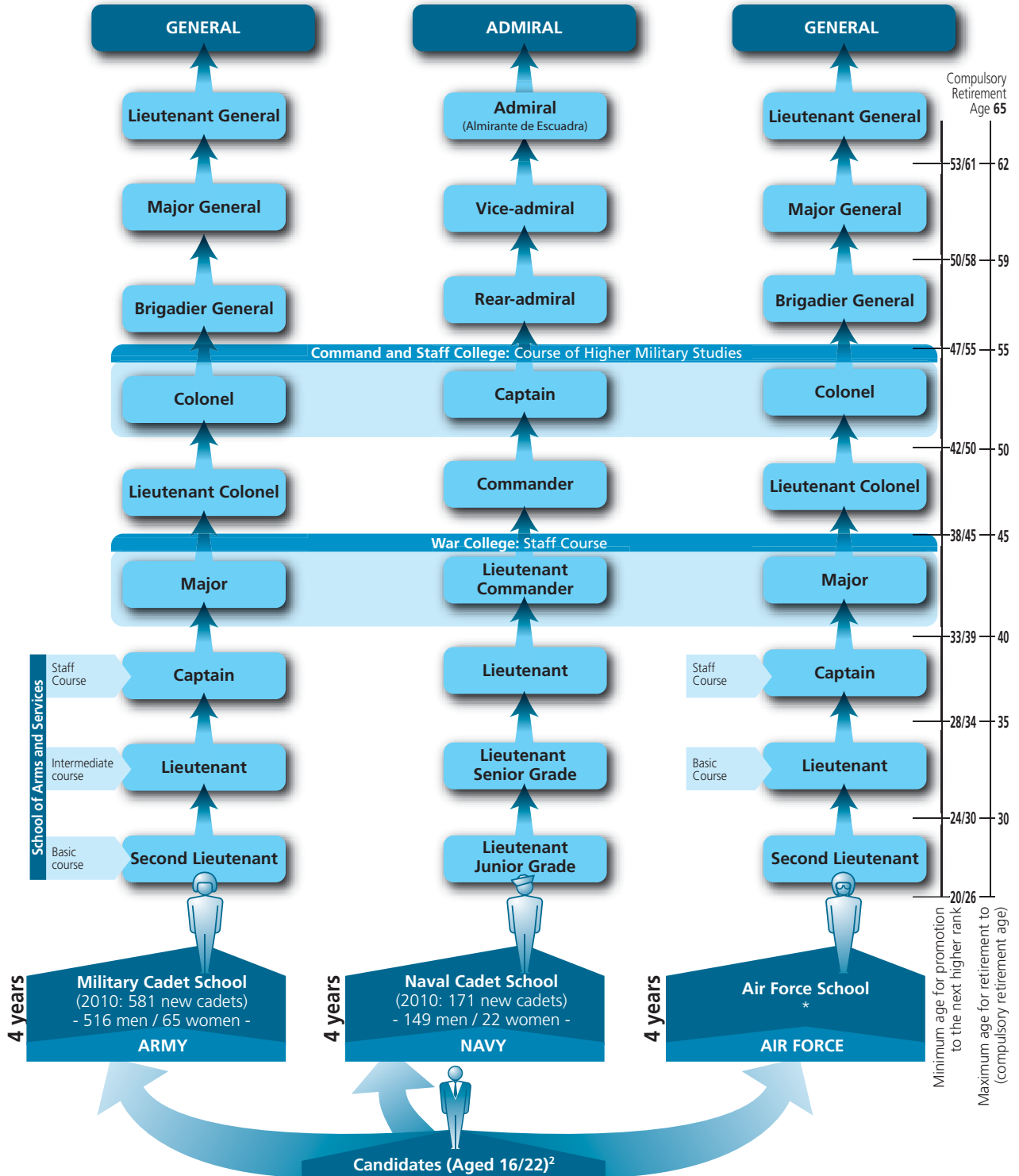

<sup>1</sup> Command corps includes officers who have been educated at military academies from the beginning of their professional careers. The graph makes a theoretical reconstruction of officers' promotion through the completion of mandatory courses. Further requirements for promotion have not been considered.

<sup>2</sup> The age of 16-22 has been considered for comparative purposes. Entry age varies depending on the Service: in the Army 16-22, in the Navy 16-21 and in the Air Force 16-22. The minimum age for promotion shall depend on age of graduation from the military institution.

\* As of September 2010, the admission process had not finished.

Source: Compilation based on *Decreto que regula las normas de carrera del personal de oficiales y suboficiales* N° 1.790 – 2000/09/14. Last amendment: Act N° 1.405 – 2010/07/28). New cadets: Military Schools.

**The Armed Forces**

**General Mission**

The Military Forces shall have the main mission of defending the sovereignty, independence, integrity of the national territory and of constitutional order. (Political Constitution, Sec. 217)

**Specific Missions**

**Army**

The National Army conducts military operations to defend and maintain national sovereignty, independence and territorial integrity, to protect the civilian population, private and state-owned assets, so as to contribute to generating a peaceful and secure environment and development to assure the Nation's constitutional order.

**Navy**

Contribute to the defence of the Nation through the effective use of a flexible naval power in maritime, fluvial and land spaces under its responsibility to comply with the constitutional order and participate in the development of maritime power and the protection of Colombian interests.

**Air Force**

The Colombian Air Force dominates and maintains control over Colombian air space and carries out air operations for the defence of the country's sovereignty, independence, national integrity and constitutional order.

**Total Strength: 268,242**



<b>Officers:</b>	
M 8,479	448 W
<b>Non-commissioned Officers:</b>	
M 30,647	897 W
<b>Troops:</b>	
M 186,073	0 W
M 99.40 %	0.60 % W
<b>Total 226,544</b>	



<b>Officers:</b>	
M 1,854	305 W
<b>Non-commissioned Officers:</b>	
M 7,660	228 W
<b>Troops:</b>	
M 21,308	0 W
M 98.30%	1.70 % W
<b>Total 31,355</b>	



<b>Officers:</b>	
M 1,802	395 W
<b>Non-commissioned Officers:</b>	
M 3,153	185 W
<b>Troops:</b>	
M 4,808	0 W
M 2.94%	17.06% W
<b>Total 10,343</b>	

**New Military Units**

Type of Unit – National Army	2002 2010
Divisions	4
Decisive Action Force	1
Task Force	6
Territorial brigades	15
Mobile brigades	18
Divisional Reaction Force	7
Groups of Urban Antiterrorist Special Forces	11
Groups of Lanceros (rangers)	1
Counter-guerrilla battalions	66
High mountain battalions	6
Infantry battalions	5
Artillery battalions	2
Engineer battalions	5
Power and road special battalions	3
Supply battalions	1
Maintenance battalions	1
Support and service battalions	11
Communications battalions	2
Forest battalions	3
Instruction, training and re-training battalions	12
Mobility battalions and aviation manoeuvres	8
Special operations battalions	7
Disaster response and prevention battalions	1
Demining battalions	1
Explosive and demolition battalions	1
Intelligence battalions	1
Cavalry group	1
Schools	14
Intelligence units	2
Intelligence regional units	8
Combat support and service companies	16
Explosive and demolition companies	4
Mobile engineer companies	4
Plan Meteoro Companies	12
Operational commands	5
Special commands	1
Special operation command	1
Specific commands	2
Logistics commands	3
Joint command	1
Divisional Marte Group	6
Instruction and training centres	24
High precision sniper units	43
Military districts	1
Medical dispensaries	1
Departments (I's)	7
Directorate	22
Offices	3

Type of Unit – National Navy	2002 2010
Navy infantry battalions	2
Fluvial task units	2
Naval bases	1
Groups of urban antiterrorist special forces	2
Coastguard station	25
Air-sea station	8
Fluvial support mobile station	10
Aircraft unit	9
Helicopter unit	3
Patrol boat	21
Administrative boat	5
Training boat	1
Coastguard commands	1
Troop armoured vehicles	9
Troop quick patrol vessel	5
Fluvial support patrol vessel	4
Ocean patrol vessel	2
Landing fast boat	2
Submarine fast boat	5
General transport craft	3
Bay towboat	1
Training sailing-ship	4
Departments (I's)	2
Directorate	5
Offices	1

Type of Unit – Air Force	2002 2010
Yopal Air Group	1
Yopal Air Base	1

**The number of civil personnel in the Forces (2010) is:**  
 - General Command: ..... 316  
 - Army: ..... 5,928  
 - Navy: ..... 1,991  
 - Air Force: ..... 2,529

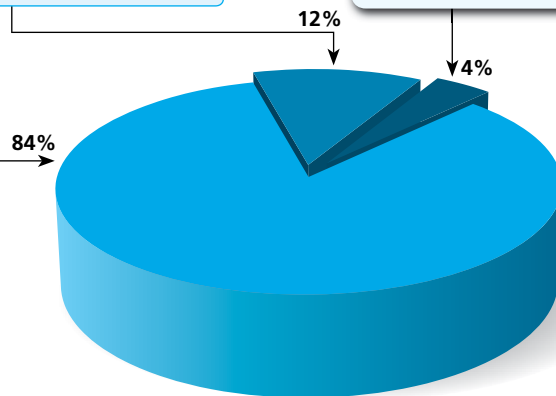

M: Men / W: Women

Source: Web pages of the Armed Forces (missions) and information provided by the Ministry of National Defence (troops). Logros de la Política Integral de Defensa y Seguridad para la Prosperidad, September 2010, Ministry of National Defence.



### Women in the Armed Forces

#### Women's Admission to the Armed Forces (year)

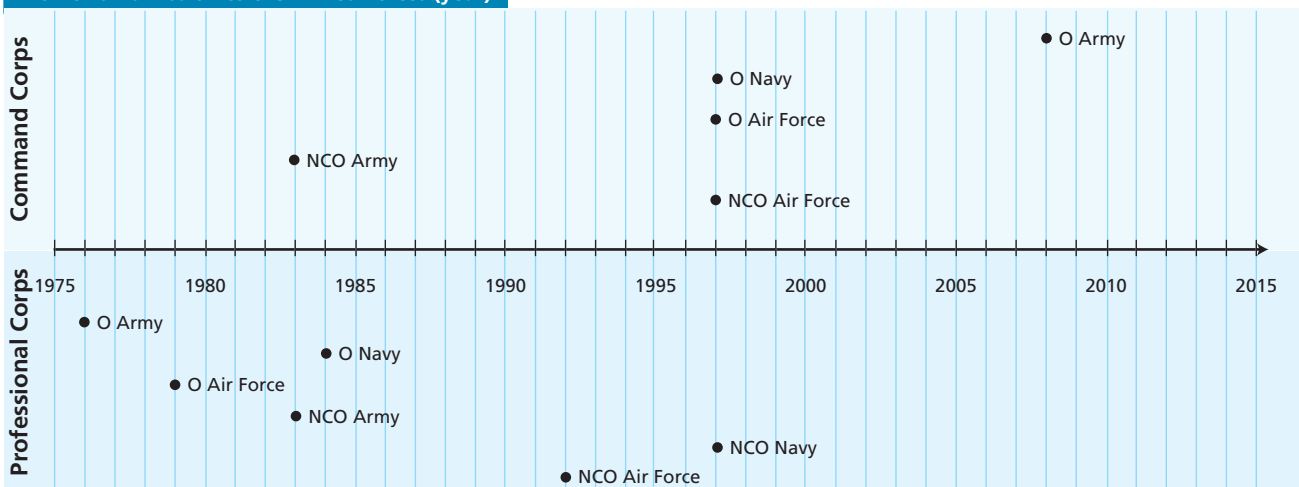

O: Officers - NCO: Non-commissioned Officers

**Note:** Women cannot be part of the Naval Force command corps as non-commissioned officers. The Command corps includes officers who have been educated at military academies from the beginning of their professional careers. The Professional corps refers to those who develop a career in the civilian sphere and are then incorporated to the armed forces.

#### Women Officers who have reached the highest rank in the Command Corps (2010)

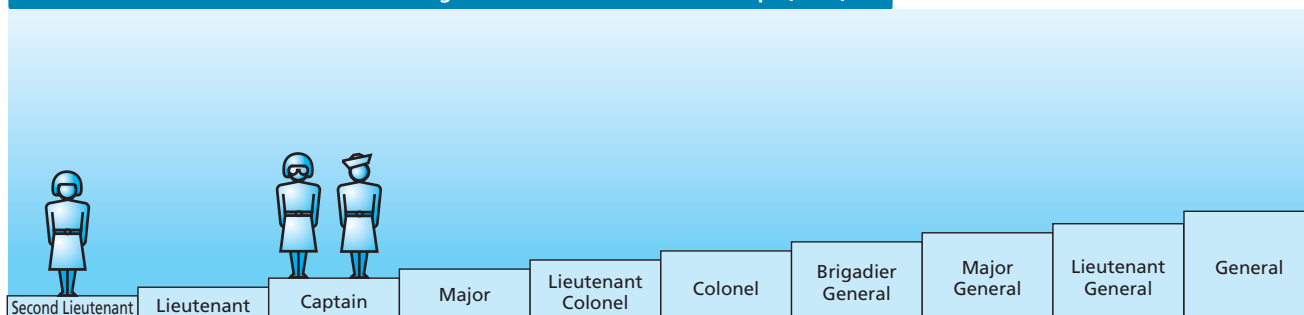

**Note:** These ranks correspond to the Army, as an example. The equivalent ranks for Captain are Lieutenant (Navy) and Captain (Air Force).

**0.92% (2,458) of the total Armed Forces are women.**

**Source:** Compilation based on information provided by the Navy, Ministry of National Defence and Project 07-184 Global Peace and Security Fund RESDAL.

### Military Service

It is mandatory for all male citizens at the conscription age, for a period of one or two years. Women shall only be liable as required by the country, and shall be assigned differentiated tasks.

**Modalities:**

- Enlisted soldier (18 to 24 months)
- Peasant soldier (12 to 18 months, in the area of residence).
- High-school graduate soldier (12 months)
- Professional (12 months)

- Soldiers, especially high-school graduates, apart from their military training and other obligations as soldiers, shall be trained to perform social welfare activities for the community, especially tasks related to ecological and environmental preservation.
- Peasant soldiers shall fulfill their mandatory military service in the geographical area where they reside. The National Government shall organize said service taking their academic background and trade into account.
- Professional soldiers work under a contract.

		Number of Soldiers (2010)		
		Army	Navy	Air Force
Soldiers	Enlisted	67,579	13,045	4,808
	Peasants	23,264	701	-
	High-school graduates	15,674	-	-
	Professionals	79,556	7,562	-
	<b>TOTAL</b>	<b>186,073</b>	<b>21,308</b>	<b>4,808</b>

**Source:** Information provided by the Ministry of National Defence and *Ley de servicio de reclutamiento y movilización* (N°48 – 1993/03/03).

## Defence and National and International Community

### Multinational Peace Force and Observers (MFO)

Colombia has been part of the MFO since 1982. This mission is independent from the UN, and was generated by the Peace Treaty between Egypt and Israel in 1979. It has an Infantry Battalion made up of 31 officers, 58 non-commissioned officers, 265 soldiers and 3 civilians (a total of 357 men).

**Source:** Web site of the Multinational Peace Force and Observers (MFO).

### Support Actions

The General Command of the Military Forces (CGFM) has developed a Joint Integral Action programme in order to assist in population needs and support the community. The Integral Action includes:

#### Consolidation Plan 2008-2014

The Plan has allowed the execution of infrastructure work totaling US\$ 11,322,283 in more than 1,100 municipalities around the country. Works include the construction and improvement of roads, parks, schools, health facilities, aqueducts and sewers.

#### Indigenous Affairs

In 2007, the CGFM created the advisory office for Indigenous Affairs. In 2009, similar offices were created in the National Army, the National Navy, the Colombian Air Force, the "Caribe" Joint Command and the Omega Joint Task Force. At present, there are 62 liaison officers of Indigenous Affairs in units where there is relevant presence of indigenous peoples, thus interacting directly with the native and indigenous organizations and communities, carrying out health support programmes as well as integration activities.

#### Inter-agency campaigns

Every year, different health support activities are carried out in different locations around the country; said activities include medical and dental care, surgeries and various specialities. During 2010, 18 campaigns have been performed.

#### Aid in case of disaster

As part of the National System of Disaster Response, in February 2009 the Public Force operated in Nariño, where floods caused a disaster affecting around 31,250 people.

Military Forces action:

- The National Navy deployed fluvial support and coastguard boats to evacuate affected people in flooded areas.
- The National Centre of Air Force Personnel Recovery deployed an air-medical evacuation platform to give support to the search and rescue efforts.
- C-130, C-295 and CN-235 aircraft for the transport of specialized personnel and equipment to assist in a disaster scenario, carrying 310 tons of supplies and 129 people.
- Medical teams of the National Navy took part in the health care campaigns.

#### Activities of the Joint Integral Action Command:

- Resolution Integral Action, support campaigns for "Plan Fronteras." 13,633 beneficiaries.
- Coordinated Integral Action, support in health care areas in coordination with the US military Group. 26,166 beneficiaries.
- General Integral Action. 329 health campaigns. 237,952 beneficiaries.

#### Soacha Plan

Conference development, provision of health services and recreational activities in the main municipality welcoming displaced persons of the country. 10,189 beneficiaries.

## Security Consolidation

### Demobilization, Disarmament and Reintegration (DDR)

Colombia is the only country where DDR has taken place in the midst of armed violence with groups with which no peace agreement has been signed. This has been accompanied by rules seeking to contribute to social and economic reintegration of demobilized persons with a regular legal situation.

The Programme of Humanitarian Aid to the Demobilized persons (PAHD) aims at providing integral humanitarian aid to the demobilized persons and their family group, facilitating their social reintegration.

#### Demobilized persons:

2002-2006:	2,389	(average)
2007	3,192	
2008	3,461	
2009	2,638	
2010	1,924	(January to September)

### Democratic Security Consolidation Policy

The PCSD, established in 2007, has the following objectives: consolidate the territorial control and strengthen the Rule of Law in all the national territory; protect the population; increase the cost to develop drug trafficking activities; maintain a modern Public Force and; keep the downward trend of criminal indicators.

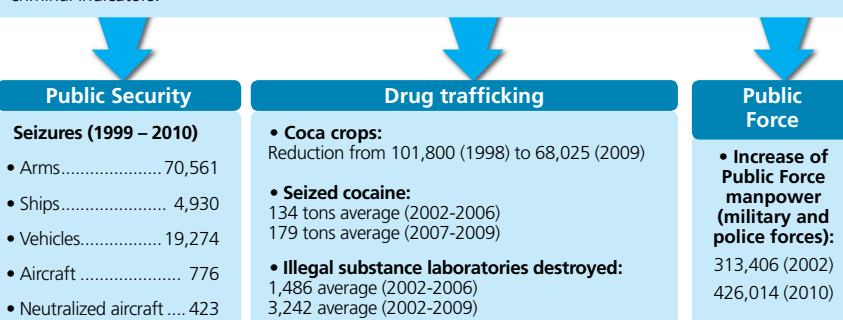

The National Consolidation Plan (PNC) is organized at an operational level in Regional Coordination Centres (CCR). The Ministry of Defence has assigned officers of the Military Forces and National Police in 10 CCRs with the main mission of providing advice, based on security criteria, to make civil decisions related to the development of each one of the areas prioritized by the PNC.

Likewise, the PNC includes a National Territorial Consolidation Plan, which aims at fulfilling the objectives of the PCSD, maintaining the confidence of investors and advancing in the effective social policy, through the reinforcement of the alignment of military, police, and antinarcotics efforts as well as those in the social and legal areas, and the economic and institutional development of the State in strategic areas of the national territory.

In this context there is a Consolidation War Plan (2007-2010), based on which the military forces jointly with other state institutions focused the operational effort in 17 strategic areas with the aim of achieving demobilization, capture or reinsertion of illegal group members by means of the implementation of the "Salto Estratégico" National Campaign.

**Source:** Presidential Instruction N°1, Presidency of the Republic of Colombia, 2009; *Estrategía de fortalecimiento de la democracia y el desarrollo social, 2007-2013; Logros de la Política Integral de Defensa y Seguridad para la Prosperidad*, September 2010, *Memorias al Congreso 2009-2010; Política de Consolidación de la Seguridad Democrática, 2007; Plan Consolidación 2008-2014; Cambio Climático, Riesgos Nacionales y Retos para la Fuerza Pública*, Research Note 2, National Ministry of Defence, and websites of the General Command of the Military Forces and the National Ministry of Defence.



## Analisis:

# From the “Strategic Leap” to “Democratic Prosperity”

### Jesús Alberto Ruíz Mora

*Director of the Institute of Military Science Research, and Researcher of the Center for Strategic Studies on National Security and Defence (CEESEDEN).*

The speech delivered by President Lleras to the Colombian military on May 9, 1958, was an undoubted landmark in Colombian security doctrine: it contributed to military force detachment from partisan politics, but, at the same time, placed civilians at a distance from national security issues<sup>1</sup>; and it was the main reason for the usual absence of security and defence policies that would have the support of civilian institutions to consolidate military forces’ successes.

The concept of *democratic security* meant a transformation of the security and defence notions in Colombia, as it resulted in the Executive Branch’s final commitment to subjects of a sensible political-strategic value for the nation. This does not mean that such commitment did not exist before, but rather that the lack of articulation between national policy and military conduct explicitly led to transforming military forces in the favourite instrument for domestic public order control, which was resorted to in recurrent but erratic manners, instead of looking for structural changes<sup>2</sup>. President Uribe’s success was underpinned by his decision to take the offensive against drug trafficking and terrorism, securing the support of several Colombian society sectors, which allocated part of their resources to the payment of the war tax, which funded the arrival of civilian and military State

authorities to a number of different and remote locations of the nation’s geography.

This was at the heart of the Democratic Security Policy (PSD; Spanish acronym), a complex strategy that not only was limited to military action to restore territorial control, but also promoted political and economic tools for the social recovery of the affected territories. Combining the work of the armed forces with the support of civilian agencies was one of the strengths of the PSD.

### The Strategic Leap

Today’s President Juan Manuel Santos, then in the capacity as Minister of Defence, was the announcer of the “*Strategic Leap*,” an offensive through the activation of joint force tasks intended to break up FARC’s military capabilities and prevent them from establishing in new territories<sup>3</sup>. The action is planned as a massive and sustained military campaign, forcing to take up men and means from different territorial spaces and concentrating military efforts to reduce the FARC’s offensive capacity. This is an operational re-engineering coupling a dominant intelligence capable of identifying very sensitive targets, with the use of tactical units highly competent for striking spe-

1 Alejo Vargas, “Alberto Lleras y los militares”, *El País*, July 1, 2006.

2 Francisco Buitrago Leal, *Defensa y seguridad nacional en Colombia, 1958-1993*, (Bogotá: Editorial Tercer Mundo, 1994).

3 *El Espectador*, “Gobierno anuncia un ‘Salto Estratégico’ para darle la estocada final a las Farc”, 31 de marzo, 2009, <http://www.elespectador.com/articulo132498-gobierno-anuncia-un-salto-estrategico-darle-estocada-final-farc>

cific objectives.

An inter-agency coordination effort is needed, which not only seeks to capture criminal organization members, but also ensure their conviction. An important element is the strengthening of border security, as well as an increase of military control on the lines limiting the areas where illegal armed groups have taken base, minimizing tactical movements in anticipation of State force action.

The “Strategic Leap” devotes a good deal of institutional efforts to strengthen the commitment of State institutions to the social and economic development of vast areas. International cooperation, intra-agency actions and institutional effectiveness represent fundamental assumptions for this work, because these are the factors capable of transforming military successes into a social and state victory.

The social recovery of the territory seeks to change the population status, evolving from simple inhabitants subject to State control, to citizens entitled to full rights and guaranties, through an institutional process involving gradual coverage by the State for the recovery of areas and populations to a civilian regime and the pursuit of development and progress<sup>4</sup>.

The transformation of the Colombian Armed Forces within the framework of Democratic Security has allowed them to have greater presence and control over the national territory, use resources in a more rational manner and maintain effective coordination between the different forces, which led to results including the elimination of important illegal leaders, disarticulation of narco-trafficking roads and rings, mass demobilization and release of kidnapped people in operations such as “Jaque,” “Camaleón” and “Sodoma.” The tactical capability contributed by Joint Commands and Task Forces should be noted, where the best of each service is committed to common strategic objectives. The Army has reduced the illegal groups’ strategic mobilization corridors, from its rearguard area in the south of the country, to the heart of the nation’s power located in the Capital of the Republic.

### **The Democratic Prosperity**

The development mobilization programs, including *Familias Guardabosques* (Wood Ranger Families), *Familias en Acción* (Families in Action), crop substitution and other social action projects of the Presidency allow the reinsertion of communities isolated from the national economy, as well as the arrival of

development-driving foreign investment. International cooperation has a unique significance (US assistance only represents US\$521.8 million).

One of the challenges for the incoming government is, apart from sustaining the military effort, to rally more resources into the programs that seek social and economic stabilization in the areas now recovered. To this end, a decided commitment of the private sector is required for the task, since it is a vital element towards the successful completion of the “*Strategic Leap*” and its coupling with “*Democratic Prosperity*”, the colors held up as national policy by the new President. “A Good Government” as the one Juan Manuel Santos pretends to lead, implies, for security and development to be effective, legitimizing State policies as a product of a convergence of efforts in all the fields of national power, joined to a national union effort.

Even more final will be the initiatives involving the armed forces in inter-agency tasks to allow countrymen returning to the fields and producing hand in hand with institutions. On the other hand, the legitimacy of men in uniform lies on their maintaining respect for human rights; the deaths of civilians, accused of guerrilla activities, perpetrated by certain Army members in criminal attitudes assumed by their own decision were a shameful page in the military institution’s history, written by its best men for the peace of all Colombians. For this reason, the Army has the imperative need to strengthen their relation with some sectors of the population, whose confidence was weakened by the so called false-positives. The institution, therefore, is charged with the responsibility to not allow the repetition of such abominable conducts, as well as to contribute to fast justice administration, thus completing the work that the Army itself started by opening the respective investigations against the presumed criminals and taking them to the competent courts of justice.

These Public Force drives will be indispensable in the mission to beat armed groups’ actions, since up to date, the only successful colonization processes have been those of coffee producers and drug-traffickers<sup>5</sup>. It is in the hands of the new leader to make of the *Strategic Leap* the road to social victory, through democratic prosperity, a fundamental State objective to attain peace.

<sup>4</sup> Ejército Nacional, “Actualidad: Salto estratégico busca llevar a las Farc al punto de no retorno”, <http://www.ejercito.mil.co/?idcategoria=218556>.

<sup>5</sup> Gonzalo Sánchez, “Guerra prolongada y negociaciones inciertas en Colombia” in *Violencias y estrategias colectivas en la región andina. Bolivia, Colombia, Ecuador, Perú y Venezuela*, ed. Gonzalo Sánchez y Eric Lair, (Bogotá: Editorial Norma, 2008).



# Cuba

## The Legal Framework and the Defence System

### National Legislation

#### Systems and Concepts

- Decree Law on the Organization of the State's Central Administration (DL Nº 67 - 1983/04/19. Last amendment: DL Nº 147 - 1994/04/21)
- National Defence Act (Nº 75 - 1994/12/21)
- Civil Measure System Act (Nº 170 - 1997/05/08)

#### Military Organization

- Military Penal Procedure Act (Nº 6 - 1977/08/08)
- Military Crime Act (Nº 22 - 1979/02/15)
- Decree Law on Social Security for Expatriates performing Civil or Military Missions (Nº 90 - 1985/12/02)
- Decree Law of Social Security for the Revolutionary Armed Forces (Nº 101 - 1988/02/24. Last amendment: DL Nº 222 - 2001/08/14)
- Act of Military Courts (Nº 97 - 2002/12/21)
- Act of Military Prosecution (Nº 101 - 2006/06/10)

**Source:** Compilation based on the legislation above mentioned. For constitutional provisions see Chapter 1.

- Advisory and assistance functional relationship
- Command reporting line

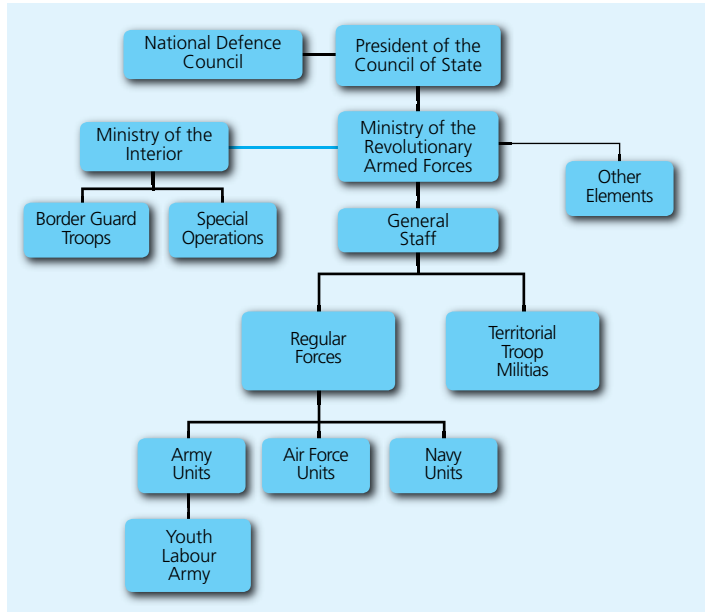

### Functions

#### Branches of Government

The National Defence Council is established and prepared during times of peace to conduct the country under conditions of state of war, during a war, in the general mobilization or state of emergency. During exceptional situations it is the highest organ of state and political power. It is presided over by the President of the Council of State, and it also includes the First Vice President of the Council of State, and five more members appointed by the Council of State at the President's proposal. The Provincial, Municipal and Zone Defence Councils are established and prepared during times of peace to conduct operations in their respective territories, under conditions of state of war, during a war, the general mobilization or state of emergency.

The system also includes the Committees for the Defence of the Revolution, as a territorial organization of the masses whose objective is to mobilize the whole population in the efforts for the defence of the Revolution.

The National Assembly of People's Power has the Powers granted by the Constitution and is permanently involved with defence related issues through the National Defence Committee.

#### Ministry Level

The Ministry of the Revolutionary Armed Forces is the organization in charge of directing, executing and controlling the enforcement of the Government and State policy for preparing the country for their defence, the defence of sovereignty and the preparation and accomplishment of the armed struggle.

#### Military Level

The General Staff assists the Minister in the conduction of the Revolutionary Armed Forces (*Fuerzas Armadas Revolucionarias*).

The Revolutionary Armed Forces are the basic military institution of the Government. They are made up of the regular troops and the Territorial Troop Militias (*Milicias de Tropas Territoriales*). The regular troops include ground, air and maritime units. The Youth Labour Army (*Ejército Juvenil del Trabajo*) is part of the ground troops of the Revolutionary Armed Forces.

The Army is the territorial grouping of forces and resources of the Revolutionary Armed Forces. It has a Military Council, made up of the Chief of the Army, the Presidents of the Provincial Defence Councils of the Army territory and other members appointed by the Minister of the Revolutionary Armed Forces. The Provincial and Municipal Staffs are military organs that are subordinate to the Chief of the Army of the respective territories.

Some organs under the Ministry of the Interior, such as the Border Guard Troops and Special Operations, are part of the Territorial Defensive System and accomplish the missions imposed by the corresponding Defence Councils and the organs and directorates of the Ministry of the Interior, in accordance with the plans approved for exceptional situations.

The Production and Defence Brigades (*Brigadas de Producción y Defensa*) constitute the armed organization of the Zone Defence Council, for developing the mass participation of citizens in the War of All the People (*Guerra de Todo el Pueblo*).

**Source:** Compilation based on the *Ley de Defensa Nacional* (Nº 75 - 1994/12/21) and websites of the Cuban Government.

## The Budget

Year	Defence and Internal Order Budget		Government Budget		GDP	
	Domestic Currency	US\$	Domestic Currency	US\$	Domestic Currency	US\$
2000	879,600,000	36,650,000	15,587,400,000	649,475,000	32,685,000,000	1,361,875,000
2001	1,273,800,000	53,075,000	15,771,000,000	657,125,000	33,819,800,000	1,409,158,333
2002	1,261,800,000	52,575,000	17,193,200,000	716,383,333	36,089,100,000	1,503,712,500
2003	1,267,300,000	52,804,167	18,622,400,000	775,933,333	38,624,900,000	1,609,370,833
2004	1,316,500,000	54,854,167	20,241,400,000	843,391,667	38,203,000,000	1,591,791,667
2005	1,649,700,000	68,737,500	27,156,400,000	1,131,516,667	42,643,800,000	1,776,825,000
2006	1,707,900,000	71,162,500	33,326,500,000	1,388,604,167	52,742,800,000	2,197,616,667
2007	1,892,400,000	78,850,000	39,992,600,000	1,666,358,333	58,603,900,000	2,441,829,167
2008	2,021,600,000	84,233,333	47,493,100,000	1,978,879,167	60,806,300,000	2,533,595,833
2009	2,126,200,000	88,591,667	46,611,500,000	1,942,145,833	62,278,600,000	2,594,941,667
2010	2,206,100,000	91,920,833	45,267,800,000	1,886,158,333	63,461,893,400	2,644,245,558

## Defence and Internal Order Budget (in %)

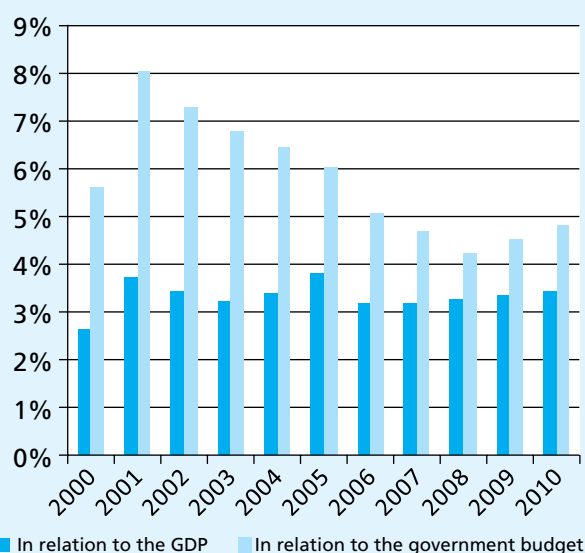

## Comparative Increase (in %)

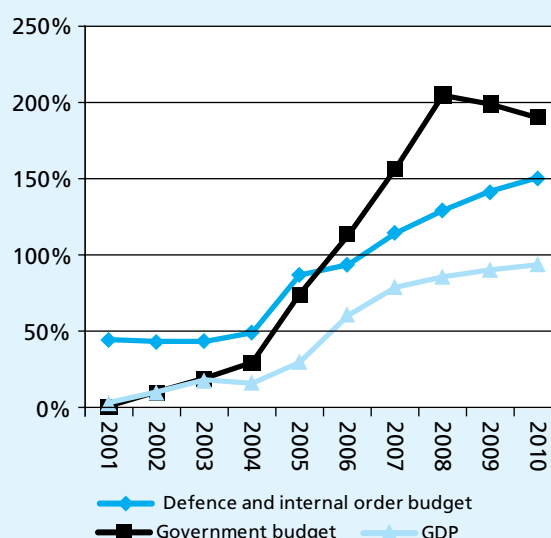

## Evolution of the Defence and Internal Order Budget (in Local Currency)

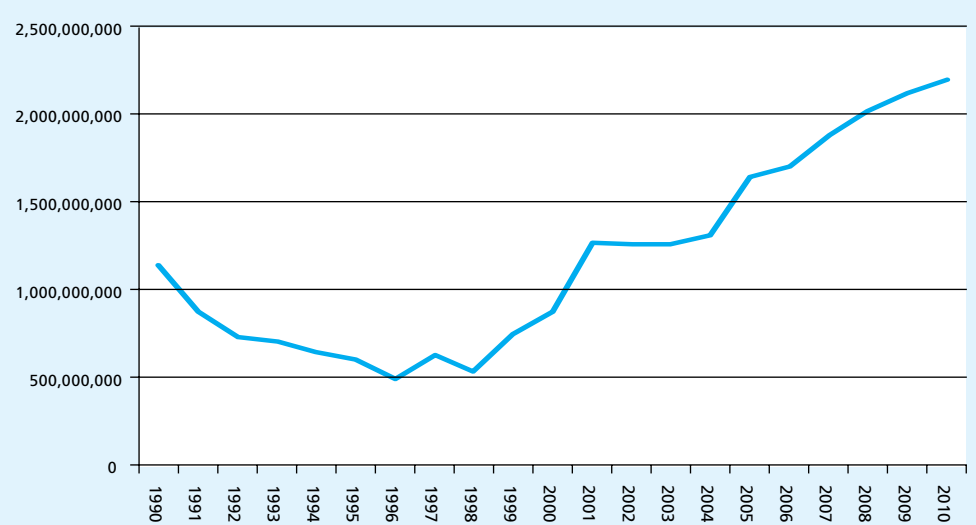

The average budget for defence and internal order in the 1990s was \$ 716,530,000 Cuban Pesos.  
In the 2000s, the average was \$ 1,539,680,000 Cuban Pesos.

Source: Compilation base on *Anuario Estadístico de Cuba* (annual reports 1995-2009) and *Panorama Económico y Social. Cuba 2009*, National Statistics Office of the Republic of Cuba. The figures correspond to execution of the State budget. 2010: *Ley del presupuesto del Estado*. GDP 2010: Estimation by the Ministry of Economy and Planning. Exchange rate: 1 Cuban Peso (non convertible) = 24 US Dollars.





**Political Definitions**

**Policy Guidelines**

The Republic of Cuba builds its national defence on its aspirations of fair, true and valid peace for all States, based on the respect for the people's independence and sovereignty and the right to self-determination, as well as on its commitment to the principles consecrated in the United Nations Charter and other international treaties Cuba is a party to.

The Cuban people have endured, since their very origins, a constant threat to their security and territorial integrity. Thus, in line with their patriotic sentiment and more vigorous courage upon the victory of the Revolution in January 1959, the country has actively been involved in its own defence and the conquest of socialism, following the experiences of the Mambi Army and the Rebel Army, massively integrating, since their creation, to the militias of workers, farmers and students as well as to the rendering of military service.

**Cuban Military Doctrine**

It is defined as the set of scientifically grounded ideas and concepts adopted by the State in relation to the essence, objectives, nature, particularities and consequences of war; the country's preparation to engage in it successfully and try to avoid it; and the methods applied to conduct and direct it in order to confront a military aggression.

Military doctrine is based on deterrence: it understands that the political, material and human cost of a military aggression against Cuba would be prohibitive and, consequently, would lack any perspective of success.

**War of All the People**

It is the basis of the military doctrine. It is understood as the strategic defensive conception of the country and it is based on the deployment of the territorial defensive system.

**Territorial Defensive System**

Set of political, economic, military, legal, security, internal order and civil defence measures and activities organized and performed in times of peace by State bodies and organizations, economic entities, social institutions and citizens, in the different levels of the political-administrative sector with the aim of guaranteeing the defence of the country.

Cuba is territorially organized in 14 provinces and 169 municipalities.

The mission of the defence zones is to conduct the armed fight in their areas; support the actions of regular troops and Territorial Troop Militias; maintain the internal order; protect the civil population; ensure the stability of production and services, guarantee the provision of supplies and the preservation of life. Production and Defence Brigades are organized and a Council of Defence, integrated by voluntary civilians, operates in each area.

**Source:** *Ley de la Defensa Nacional* (Nº75 - 1994/21/12). Cuban Ministry of Foreign Affairs, *Informe Cuba vs. Bloqueo 2009*.

**Ministry of the Revolutionary Armed Forces**

On October 16th, 1959, the Ministry of the Revolutionary Armed Forces was created in accordance with Law Nº 600 of the Council of Ministers. This Ministry brought together the Rebel Army, the Revolutionary Navy and the National Revolutionary Police.

Current minister: General of the Army Corps Julio Casas Regueiro

Previous ministers:  
General Raúl Castro (1959 – 2008)  
Augusto Martínez Sánchez (1959)

**Reports Submitted to the United Nations**

1997	1998	1999	2000	2001	2002	2003	2004	2005	2006	2007	2008	2009
✘	✘	✘	✘	✘	✘	✘	✘	✘	✘			

Register of Conventional Arms: ✘ Register of Military Expenditures: ◆

**Source:** Compilation based on reports submitted to the United Nations Register of Conventional Arms and the United Nations Instrument for Reporting Military Expenditures

**Blockade**

Cuba considers the embargo imposed by the United States as an act of genocide by virtue of paragraph c, Article II of the 1948 Geneva Convention on the Prevention and Punishment of the Crime of Genocide and as an act of economic war, according to the provisions of the declaration regarding Maritime War adopted by the 1909 London Naval Conference.

Cuba will continue to denounce the US policy's extraterritoriality, while demanding strict observance of international law, particularly claiming the people's right to their self-determination and State sovereignty.

**Source:** Cuban Ministry of Foreign Affairs, *Informe Cuba vs. Bloqueo 2009*. Granma Newspaper, *Informe sobre Bloqueo al 57 periodo de la Asamblea General de las Naciones Unidas*. Declaration of the Government of the Cuban Republic, January 11, 2002.

**Guantanamo Bay Naval Base**

The U.S. Naval Base in Guantanamo Bay is a facility covering 117.6 square kilometers in Cuba's national territory, occupied since 1903 as the result of an Agreement on Coal refueling and Naval Stations signed by the U.S. and Cuban Governments, based on the enforcement of an amendment approved by the US Congress and signed by President McKinley in March 1901, known as the Platt Amendment.

**Platt Amendment (1901)**

It entitled the United States to intervene in Cuba, as a condition for US troops' withdrawal from Cuban territory and the independence of the island.

In line with this clause, the aforementioned Agreement on Coal Refueling and Naval Stations was signed in February 1903 in Havana and Washington, respectively, and it actually included two areas from Cuban territory: Honda Bay and Guantanamo Bay, although a naval base was never established in the former.

Article II of the Agreement literally stipulated the right of the United States to "do anything necessary for these sites to be in condition to be used exclusively as coal refueling and naval stations and for no other purposes."

In addition to this Agreement signed in February 1903, on May 22 of that same year the Permanent Treaty of Relations between Cuba and the United States was signed, and included the eight (8) clauses of the Platt Amendment literally taken and converted into the articles of the Treaty.

Twenty one years later, on May 29, 1934, in the spirit of the American "Good Neighbour Policy," under the administration of Franklin Delano Roosevelt, a new Treaty of Relations between the Republic of Cuba and the United States of America was signed, which annulled the 1903 Treaty and thus the Platt Amendment.

This new Treaty definitely excluded Honda Bay as a possible base, but maintained the permanence of Guantanamo Naval Base, as well as the regulations governing it.

The supplementary agreement also stipulated that the United States would pay the Cuban Republic for the lease of 117.6 square kilometers —i.e. 11,760 hectares including large part of one of the best bays in the country— the amount of two thousand dollars on an yearly basis, which currently amounts to 4,085 dollars per year, payable in annual checks which Cuba has refused to collect.

The Cuban government's position regarding the legal status of the American Naval Base at Guantanamo is that, being under the legal form of a lease, it does not grant a perpetual right but a temporary one over that part of the territory, for which, in due course, as a fair right of our people, the illegally occupied territory of Guantanamo should be returned by peaceful means to Cuba.

This military enclave is precisely the central place where American and Cuban soldiers find themselves face to face and, therefore, where utmost calmness and sense of responsibility are required.

Cuba has made enormous efforts to implement an especially careful and fair policy.

In spite of the considerable increase in military personnel required by the operation, we believe it does not represent a threat of any sort to the country's security. Therefore, we will not increase highly-trained Cuban military personnel or means at the premise perimeter. Such

highly qualified personnel are also adequate to ensure people's security in the area against any risk that may arise as a result of the transfer of foreign prisoners to that base.

Cuba will make its best efforts to maintain peace and mutual respect in that site, as it has done in the last few years.

A basic principle of the Cuban policy for addressing this potentially dangerous issue between Cuba and the United States, which has persisted over the years, has been to prevent our claim from being a first priority or placing especial focus on this subject, considering the numerous and serious differences existing between both countries, and recognizing that, in recent years, a more calm environment of mutual respect has reigned over the matter.

**Source:** Declaration of the Government of the Cuban Republic, January 11, 2002. Cuban Ministry of Foreign Affairs, *Libro Blanco. Informe Cuba vs. Bloqueo 2009*.



**1934 Treaty**

It revokes the 1903 Coal Treaty thus invalidating the Platt Amendment. It maintains the presence of the Guantanamo Naval Base.

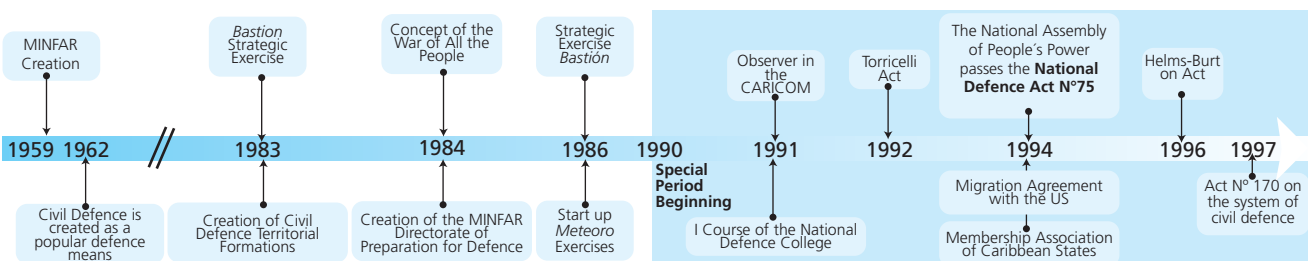



**Military Career**

**Commissioned Officers' Career Path <sup>1</sup>**

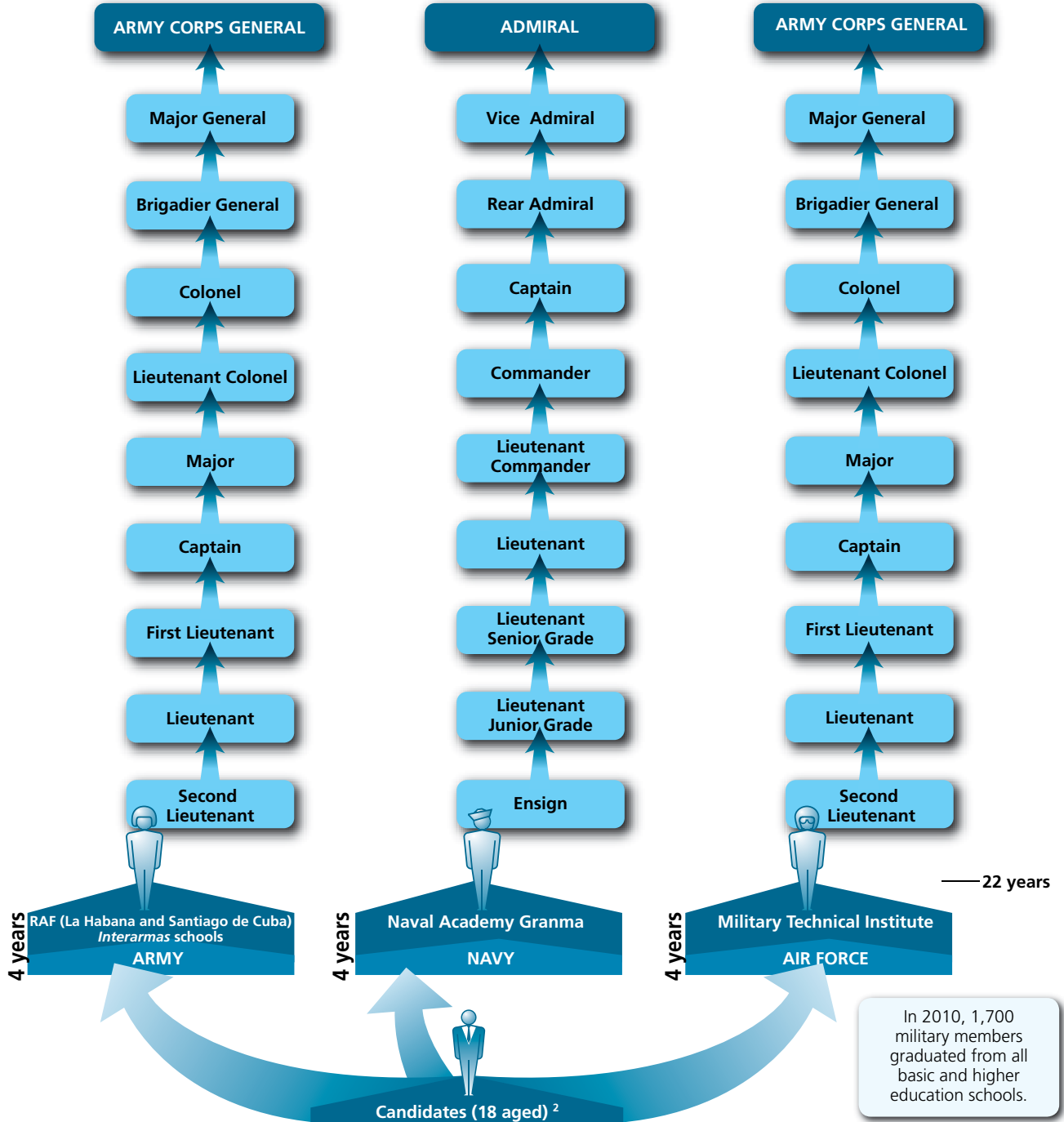

1 Command Corps includes officers who have been educated at military academies from the beginning of their professional careers.

2 The age of 18 years have been considered for comparative purposes, but it can vary based on school requirements.

**Camilo Cienfuegos Military Schools**

Young people of both sexes, who have graduated from secondary school (nine levels), and want to become officers of the Revolutionary Armed Forces (FAR), can enter these military vocational preparatory centres.

Camilo Cienfuegos Military Schools are under the direction of the FAR; there are fourteen of them across the country. Bachelors in science and arts are graduated from these colleges. The graduates are directly admitted to the military instruction centres where FAR soldiers are trained.

**Source:** Compilation based on *Ley de la defensa nacional* (Nº 75 – 1994/12/21), website of the Ministry of the Revolutionary Armed Forces, Granma Newspaper and *Gaceta Oficial de Cuba*.

### The Revolutionary Armed Forces

#### General Mission

The Revolutionary Armed Forces are the main military institution of the State, whose main mission is to combat the aggressor from the very first moment and then, with the entire people, conduct the war during the time necessary, under any circumstance, until the victory is attained. (*Ley de Defensa Nacional*, N° 75 – 1994/12/21, Sec. 34).

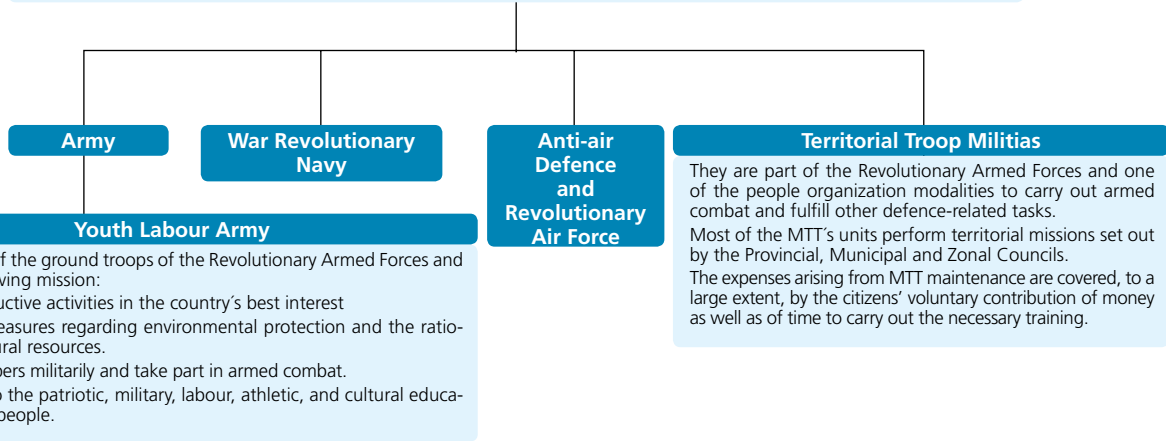

#### Military Service

According to the National Defence Act, the military service is compulsory for all male citizens and voluntary for women. The military service lasts two years and is carried out at Armed Forces' and the Ministry of the Interior's facilities.

The main objective is training citizens to carry out the defence of their country from their positions in the Military Service Reserve (up to 45 years of age), the Territorial Troop Militias, the Production and Defence Brigades or to perform any other responsibility assigned to them.

The Military Service Reserve also has to complete the regular troops. Part of the combat means is kept during peace times, only a minimum portion of the resources stays active, particularly those positions which involve greater training and specialization.

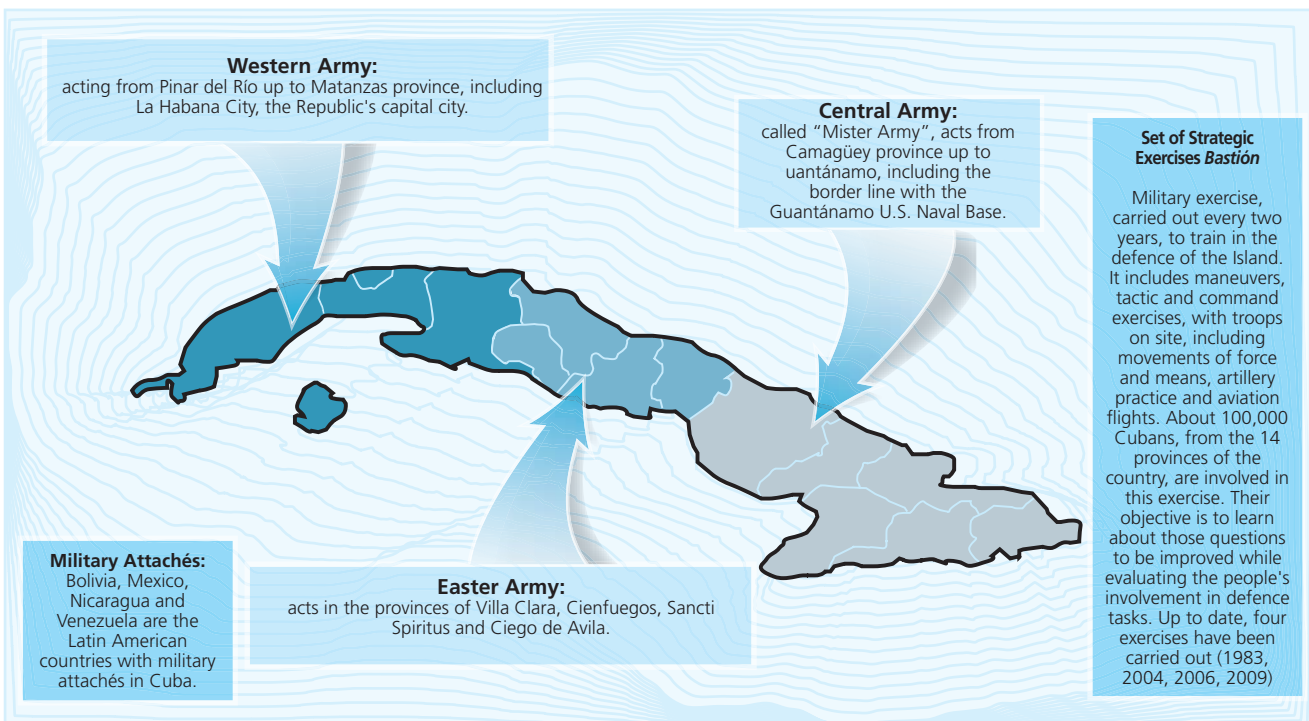

Source: Compilation based on *Ley de la defensa nacional* (N° 75 – 1994/12/21) and information presented by the Ministry of Foreign Affairs of Cuba, *Gaceta Oficial de Cuba* and Granma newspaper.



**Defence and National and International Community**

**Fight against Drug Trafficking**

Even though Cuba is not an important consumer or producer of illegal drugs, its territorial ports, waters and airspace are susceptible to drug trafficking from the countries of origin. That is the reason why, during the last 10 years, the Cuban Government has been following a policy of anti-drug trafficking operations across the country through awareness campaigns. As part of the Ministry of the Interior structure devoted to fight drug trafficking, the Cuban Government has set up the National Anti-Drug Directorate. Said directorate conducts the Ministerial System of Drug-Fighting, which addresses, in an operative and strategic way, international drug trafficking, its impact on internal trafficking and other associated crimes.

**Hacha Operation**

It began in 2001 to disrupt air and sea trafficking, recover narcotics, and deny refuge to drug smugglers within Cuban territory and waters; this is done through the Ministry of the Interior, the border Guard Troop and the Ministry of the Revolutionary Armed Forces (War Navy and Air Force). During the operations, the Government uses military helicopters, the border Guard Troop and patrol ships as well.

**People's Shield**

In effect since 2003, it has the objective of minimizing drug availability in the internal market.

**Cooperation with the United States**

The United States has an appointed representative of the US Coast Guard (1) in the Section of Interest (2). Said representative acts as the main leader in the anti-narcotic cooperation with the hosting country in specific cases. Cuban authorities give the representative constant access to Cuban-led actions against drug trafficking, including information of crime investigations, with the names of the suspects and the ships involved.

(1) Its main mission is to fight illegal migration.

(2) The United States of America has a Section of Interest in (USINT) in La Habana, which represents the American citizens and the Cuban Government. It operates under the legal protection of the Swiss Government. Section of Interest personnel offer the whole range of consular services to American citizens.

**The Armed Forces and the Economy (1)**

During the last years, the Revolutionary Armed Forces (FAR) have increased their role in Cuban economy. The need arising during the "special period" and the need to streamline the economy have accelerated this trend towards participation.

Significant elements of the economy are under the control of the Forces or coordinated by military officers who are on duty or retired.

Many of the most dynamic economic sectors - tourism, agricultural products, tobacco, among others- are managed by the FAR.

The main example within this economic scheme is the **Military Industrial Union (UIM)**, whose mission is to ensure the repair of armament and the technique applied in FAR ground, air and sea units. The General Repair Base system and other industrial companies have facilities all across the country (12 industries operating in 16 facilities throughout the island, located in 8 of the 14 provinces - Santiago, Camagüey, Sancti Spiritus, Villa Clara, Cienfuegos, Matanzas, Habana, and La Habana city). It includes large workshops specialized in tanks, artillery, aviation, naval aspects, radio communications, transportation, radars and metallurgic production.

**The FARs are present in other main sectors:**

**Habanos S.A.:** exporter and distributor of Cuban tobacco abroad.

**Comercio Interior y Mercado Exterior:** initially, this company focused on imports and exports. It has expanded to businesses operating in dollars (supermarkets, gas stations, car rentals, travel agencies, real estate and cable and satellite television services).

**Industria Cítrica:** mixed company held by the Cuban Government, mainly consisting of the Youth Labour Army, and an Israeli company.

**Instituto Nacional de la Reserva Estatal (INRE):** supervises national strategic reserves in case of emergency pursuant to Section 128 of the national defence Law.

**GAESA (Grupo de Administración Empresarial S.A.):** assets and currency management mainly.

**Unión Agropecuaria Militar:** funded in 1990, composed of farms and food production centers.

**Main other firms with military management**

<b>Aero Gaviota</b> (airline/tourism).
<b>Agrotex</b> (agriculture).
<b>Almest</b> (tourism, real estate).
<b>Antex</b> (technical consultancy).
<b>Almacén Universal</b> (free trade zone).
<b>CIMEX</b> (foreign exchange).
<b>Complejo Histórico – Militar Morro Cabaña</b> (military museum, monuments).
<b>Cubanacán</b> (tourism).
<b>División Finanzas</b> (currency recovery).
<b>Gaviota S.A.</b> (tourism).
<b>Geo Cuba</b> (cartography, real estate, mining interests).
<b>Sasa S.A.</b> (automobile services and spare parts).
<b>Sermar</b> (exploration in Cuban waters, naval repairs).
<b>Tecnotex</b> (imports/exports).

(1)The economic crisis arising in the 1990s has led to constant changes in the role of the Revolutionary Armed Forces in Cuban economy. This section is only a brief summary of such role.

**Source:** Compilation based on information provided by the websites of the Ministry of Foreign Affairs and of the Revolutionary Armed Forces; Bureau for International Narcotics and Law Enforcement Affairs, *International Narcotics Control Strategy Report*, march 2010; Cuba Transition Project, Cuba Facts 9; and *Juventud Rebelde*, april 2010.

### Civil Defence

Cuba is conceived "as a system of defensive measures of state nature". Those measures are executed in peace times and in exceptional situations to protect the population and the national economy in the event of natural disasters or other type of contingencies, including those caused by environmental deterioration.

The Cuban territory is organized in 14 provinces. Within each province, the conception and practice of the Defence Councils in the defence areas are key in case of disasters. In exceptional situations, in the municipalities, more than 1,400 defence zones are activated; these zones have been the basis of the territorial defence structure since 1984.



#### Civil Defence Principles

- Direction at the highest level
- Multi-faceted protection
- National and institutional scope.
- Differentiated form for protection planning and organization.
- Effective cooperation with the Armed Forces and the Ministry of the Interior
- Organization consistent with the country's socioeconomic development.

The defence areas, in exceptional situations, become the ultimate State representative bodies, thus assuming authority in these territories.

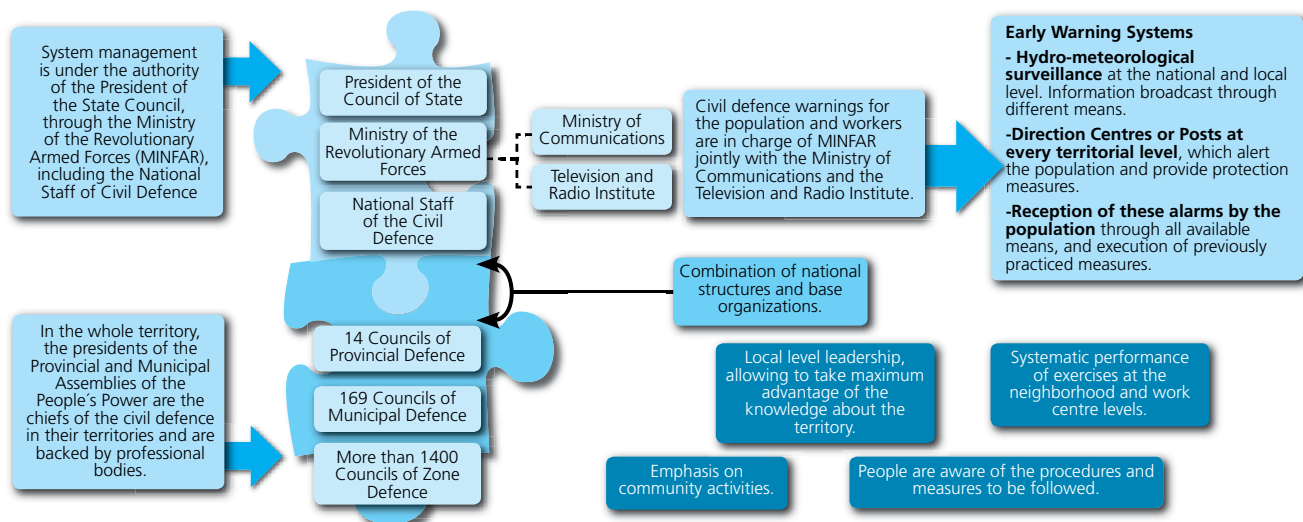

#### National Staff of the Civil Defence

It is the system's main body in charge of ensuring compliance with civil defence measures, rules and international agreements related to civil protection to which the Cuban Republic is a party; it is also in charge of coordinating international cooperation and aid in catastrophes. It maintains work relations and close and fluent cooperation with institutions committed to human life and environment protection and with the mass media as well. Likewise, it coordinates its actions and closely cooperates with non-governmental organizations, such as the Cuban Red Cross, the International Red Cross, Red Crescent organizations and others, which provide humanitarian aid in case of disaster.

#### Meteoro Exercise

This training has been conducted in Cuba since 1986. The exercise aims at the preparation and performance of actions to respond in extreme situations of hydro-meteorological or technological disasters. The 2010 Meteoro Exercise was, for the first time, divided into two stages: from May 21-23, and from June 25-26. The first stage is intended to reduce vulnerabilities related to hurricanes, draughts and adverse health events; as well as the preparation of the Defence Councils at every level (direction and command bodies). The second stage focuses on the procedures to be followed in case of high intensity tidal waves and earthquakes.

#### Response to Tsunami warning as a Result of the Earthquake in Haiti

Nearly 30,000 people were evacuated as instructed by the Municipal Defence Council (CDM) in Baracoa, province of Guantánamo, due to the tsunami warning arising from the earthquake that struck Haiti on January 12, 2010. Soon after the CDM issued the warning, local residents in high risk areas were evacuated in less than one hour to the city's highest areas.

#### Examples of Emergency Actions in Baracoa

Baracoa was struck by the phenomenon known as well as Hurricane Ike in March and September 2008. Early warnings allowed residents to leave their homes in advance and guarantee the safety of 40,000 people.

Source: Compilation based on *Ley del sistema de medidas de defensa civil* (Nº 170 – 1997/05/08); website of the Ministry of the Revolutionary Armed Forces; National Staff of the Civil Defence, comunicués and *Guía para la realización de estudios de riesgo para situaciones de desastres*, 2005.



## Analisis:

# The Armed Forces in the Cuban Transition

### Rafael Hernández

Political scientist. Director of *Temas* magazine.

The Revolutionary Armed Forces (RAF) perform strategic activities for national defence, which continues to be a priority after the end of the cold war. However, their roles and focus during the political transition process and Cuban reinsertion in the Hemisphere have changed. In their not-so-new functions as political and administrative officials, Cuban service men have become instrumental to the reforms. However, claiming that they are the masterminds of the political transition would be a mistake.

The military component of Cuban foreign policy has changed since the end of the cold war. The same generals who won the Angola campaigns have implemented the reduction of military means and troops, as well as the assumption of new roles by the RAF. Subject to restrictions and fundamental changes as deep as those undergone by the rest of the society, they have experienced a transformation comparable only to the one occurred when they became professionals in the '60s.

The new roles of the RAF have not been a threat to system stability. On the contrary, the Cuban regime have shown better skills than others in the region to restructure its military officer's agenda --following a long period of intense warfighting outside their territory and amidst tough economic realities-- and to make them not only compatible with but functional to a complex transition that has been transforming the Cuban socialist system itself.

### The Military in the Economic, Political and Legal Scenarios of the Transition

In 1989, the trials of high officials of the Ministry of the Revolutionary Armed Forces (MINFAR) and the Ministry of the Homeland<sup>1</sup> (convicted on charges of negotiation with drug trafficking organizations, corruption, abuse of power and fraud), the fall of the Berlin Wall, the dissolution of the Eastern European socialist bloc, the military retreat in Africa and the negotiation of the Central American conflict would open a new stage in Cuba, which was given a name taken from military contingency plans: *the special peace time period*.

In addition to the crisis and disarticulation of the socialist camp, the new international context created by the end of the cold war drove the economic redesign of the defence system. This adjustment, however, can be traced back to the beginning of the '80s when the military relations with the URSS<sup>2</sup> were redefined and the US threat regained momentum.<sup>3</sup> After the economic meltdown and the termination of their missions abroad,

1 *Causa Uno. Fin de la conexión cubana*, (La Habana: Editorial José Martí, 1989).

2 The URSS informed Cuba that it would not extend its defence umbrella over the isle vis-a-vis American threats in 1981-83, except for weapon supply. *Entrevista de Raúl Castro a El Sol de México (II Parte)*, (La Habana: Editorial Capitán San Luis, April 24, 1993).

3 General Alexander Haig's proposal, known as "going to the source" in the Central American conflict. Alexander M. Haig Jr., *Caveat: Reagan, Realism and Foreign Policy*, (New York: Macmillan, 1984).

the RAF were too big and costly. From 1990 on, procurement of weapons, weapon systems and pieces of equipment was greatly reduced. This reduction mainly affected the air force and the navy and emphasized the classical role of the army and the Territorial Troop Militias (TTM) as the core of the defence system.<sup>4</sup>

The RAF have been the object and the subject of transition policies. The 1992 constitutional reform established the National Defence Council, as the supreme political and military body in times of war, made up of the president, the vice president and five State Council members. Provincial, municipal and defence areas were created as well. These and other concepts were subsequently transcribed in the new national defence act. Their current role can only be understood if, in addition to these constitutional issues, their place in Cuban political process is properly analyzed.

Since 1959, the command structures, first emerged from the Rebel Army and then from the Revolutionary Armed Forces, took over the positions from which the country's political and economic conduct was exercised. Their presence in the Cuban Communist Party's Central Committee or the Council of Ministers is not new.<sup>5</sup> Its origin has been in the three main organizations opposing the dictatorship in 1958 (*Movimiento 26 de Julio*, *Directorio Revolucionario Estudiantil 13 de Marzo* and, to a lesser extent, *Partido Socialista Popular* –communist), the military structures of which attributed officer ranks to many of their leaders. However, their social and professional background was not military but civilian, and so were their main activities all along the process. Nobody in Cuba would deem them today as military men.

Although the presence of men in uniform within the current CCP's Central Committee is quite smaller than it was in the first one, of 1965, the politician profile of governing members originated from the RAF has become higher since the '90s. Despite the election of Raul Castro, former RAF Minister as President of the Republic, however, it would be wrong to assume that political decision-making in Cuba belongs

to the military. Key agencies involved in the new Cuban policy, including those controlling foreign investment, tourism, banking and finance, foreign relations, global economy, most of CCP apparatuses and provincial chiefs' offices are under civilian control, and so are those in charge of justice, culture, education, the National Assembly, trade union, rural, women and juvenile organizations' leaderships.

The two most outstanding features of the new role of the RAF in the economy have been their extension to non traditional industries and their involvement as the laboratory for new forms of economic organization. In addition to agriculture, since the '90s, they have expanded their activities to investment in and construction of strategic-importance buildings, such as those for tourism. As regards the second feature, the RAF's economic experiments have contributed to the debate of ideas among Cuban experts and economists since the late '80s, particularly involving business organization.

Although the background of military men in certain government positions has risen, their roles do not match what has been called the 'soldier entrepreneur' in other countries.<sup>6</sup> Cuban military have not been awarded exclusive areas or "feuds," nor do they exercise discretionary decision making authority over reserved areas of specialization and action. When a high-rank officer is appointed to a civil function, his responsibility and authority cease to respond to the RAF or to specific military interests. Finally, service men do not invest personal assets in private sector undertakings, as nationals' investment in private businesses is illegal in the Isle. On the other hand, public order and protection of life and property are shared with other agencies, including the Defence Committees, the physical protection committees (in charge of the security in every public venue), business and bank protection services, and so on.

The main issue for the RAF in the long run would be to maintain the current balance between their fundamental mission, namely the defence of the nation, and the multiple roles assigned in the political transition. For that purpose, it should require to ensure those roles do not overstep certain limits, so the nature of the military institution is not affected and their social functions and their role within the political system remain unharmed.

4 Military expenditures would plunge from 4.2% of the GDP in 1989 to 1.6 % in 1995, which in absolute terms would mean a 4.7-fold reduction in military spending, while the almost 300,000 troops went down to just 70,000. Stockholm International Peace Research Institute, *Cuba - Military Expenditures, Armed Force, GNP, Central Government Expenditure and Population, 1985-1995*, (Stockholm: SIPRI, 1997).

5 Some authors point out that this is the expression of Cuban society's militarization. Marta San Martín y Ramón L. Bonachea, "The Military Dimension of the Cuban Revolution", in *Cuban Communism* ed. Irving L. Horowitz, (New Brunswick: Transaction Books, 1972), p. 389.

6 Consuelo Cruz and Rut Diamint, "The New Military Autonomy in Latin America", *Journal of Democracy*, Volume 9, Number 4, (October 1998).





# Dominican Republic

## The Legal Framework and the Defence System

### National Legislation

#### Systems and Concepts

- Organic Act of the Armed Forces (N° 873 - 1978/08/08)

#### Military Organization

- Code of Justice of the Armed Forces (Act N° 3.483 - 1953/02/13)

— Advisory and assistance functional relationship  
 — Command reporting line

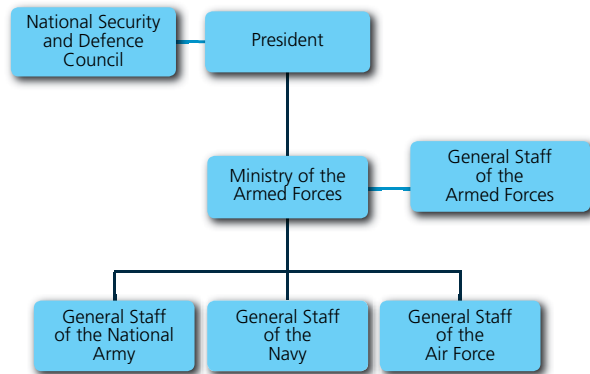

The President may receive the advice of the National Defence and Security Council. A General Officer is the Minister of the Armed Forces, the highest military authority and directly subordinate to the President. The General Staff is the consultative body and is composed of the Chief of the General Staff, the Undersecretaries of State of the Army, the Navy and the Air Force, the Chiefs of Staff of the Armed Forces, the Inspector General and the Legal Advisor of the Ministry. The Congress holds the powers granted by the Constitution and permanently monitors defence related issues through the specific committees in both Houses.

**Source:** Compilation based on the legislation above mentioned. For constitutional provisions see Chapter 1.

**Source:** Compilation based on the Political Constitution and the *Ley orgánica de las Fuerzas Armadas* (N° 873 – 1978/05/08).

## The Budget

Year	Defence Budget (in US\$)	Government Budget (in US\$)	GDP (in US\$)
2006	213,117,635	4,744,851,319	24,575,000,000
2007	265,058,384	7,631,518,941	35,494,000,000
2008	269,120,373	8,416,481,414	37,698,000,000
2009	311,355,315	8,928,070,214	44,716,000,000
2010	332,298,929	10,215,566,144	50,055,000,000

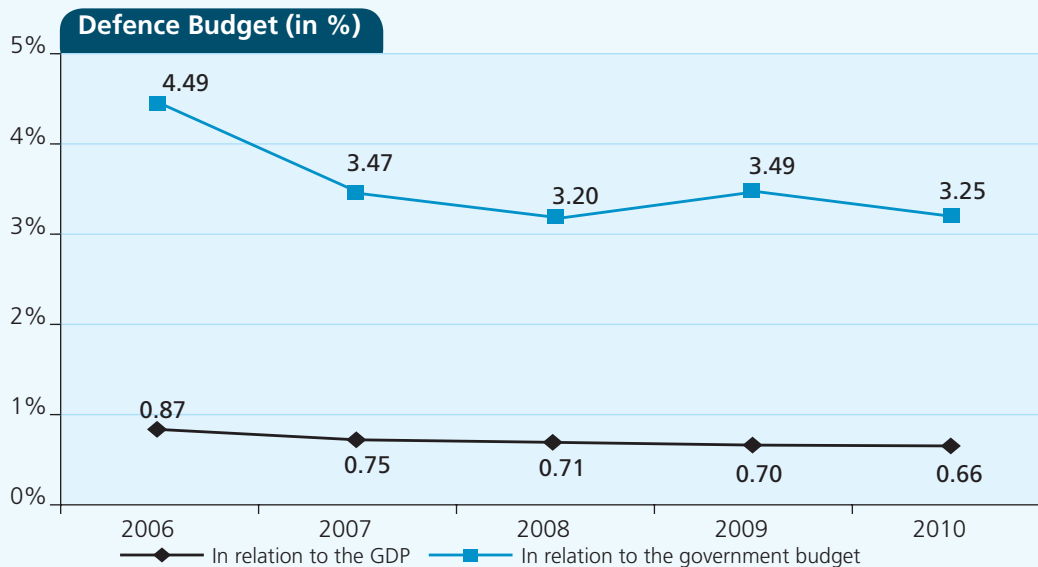

**Defence Budget Breakdown**

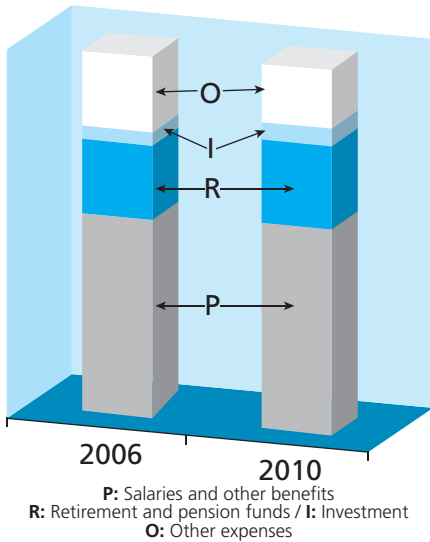

**Comparative Increase (% variation 2006-2010)**

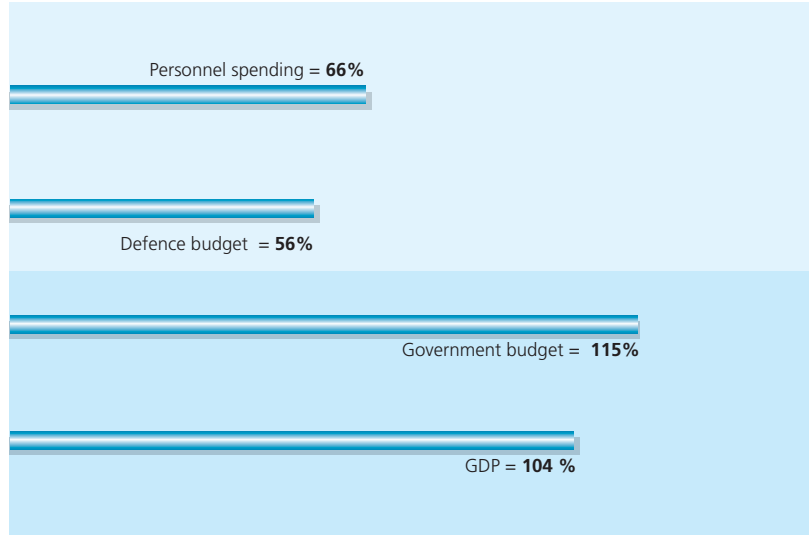

**Defence Budget 2010 (in Local Currency)**

Chapters	Personnel Services	Non-personnel Services	Materials and Supplies	Others*	TOTAL
<b>Ministry of the Armed Forces</b>					
Ministry of the Armed Forces	809,970,445	112,537,274	381,659,820	3,114,416,331	4,418,583,870
National Army	3,167,814,557	66,222,285	259,378,176	12,976,408	3,506,391,426
Navy of War	1,310,296,703	29,606,031	297,062,629	30,774,044	1,667,739,407
Dominican Air Force	1,732,281,376	57,114,113	352,796,660	593,383,432	2,735,575,581
<b>TOTAL</b>	<b>7,020,363,081</b>	<b>265,479,703</b>	<b>1,290,897,285</b>	<b>3,751,550,215</b>	<b>12,328,290,284</b>

\* It includes cash transfers, capital transfers and non financial assets.

**Composition of Defence Budget 2010**

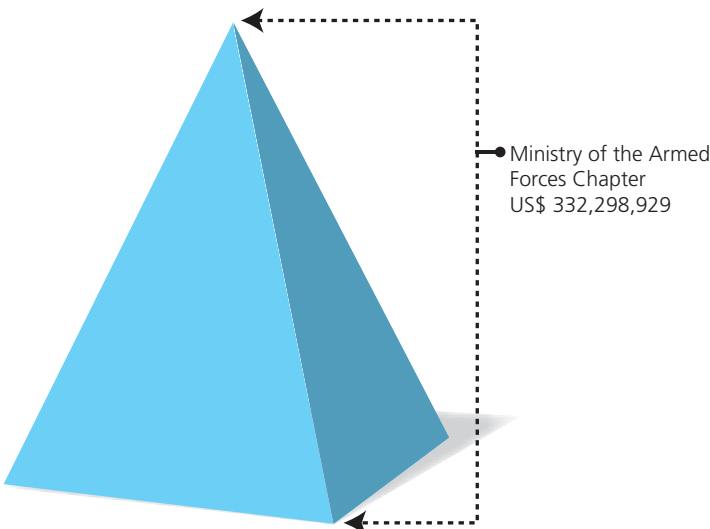

Since 2008, ships and aircraft were acquired through external loans for the War Navy and Air Force. As of 2010, US\$ 59,878,531 have been paid. Such number accounts for 6.56% of the defence budget in the last three years.

**Source:** Compilation based on Presupuesto de ingresos y Ley de gastos públicos 2006, 2007, 2008, 2009 and 2010. The State Budget passed by the Congress by means of the above mentioned Act is considered herein. The concept of investment is that expressed in "Non-financial assets".  
 GDP: Projection of the World Economic Outlook Database, IMF, of each year under review. This source has been taken for comparative purposes. Each country prepares the budget based on its own GDP estimation. The dollar value considered corresponds to the exchange rate determined by the World Economic Outlook Database, IMF, for each year under consideration. As of July, the 2010 exchange rate average is 36.55 Pesos, based on the data provided by the Central Bank of Dominican Republic. For further calculations, figures are provided in local currency. Expressions in Bold Type (Table) make reference to the various defence budget items, which can be found in a sector-based or institutional classification of the Budget Act.



**The Ministry of the Armed Forces**

**Responsibility:**

The Ministry of the Armed Forces, closely assisting the President of the Republic, is the highest military authority in all matters related to the command, organization, training and administration of the armed corps.  
 (Ley orgánica de las Fuerzas Armadas, N° 873 – 1978/08/08, Sec. 50)

**Organization Chart**

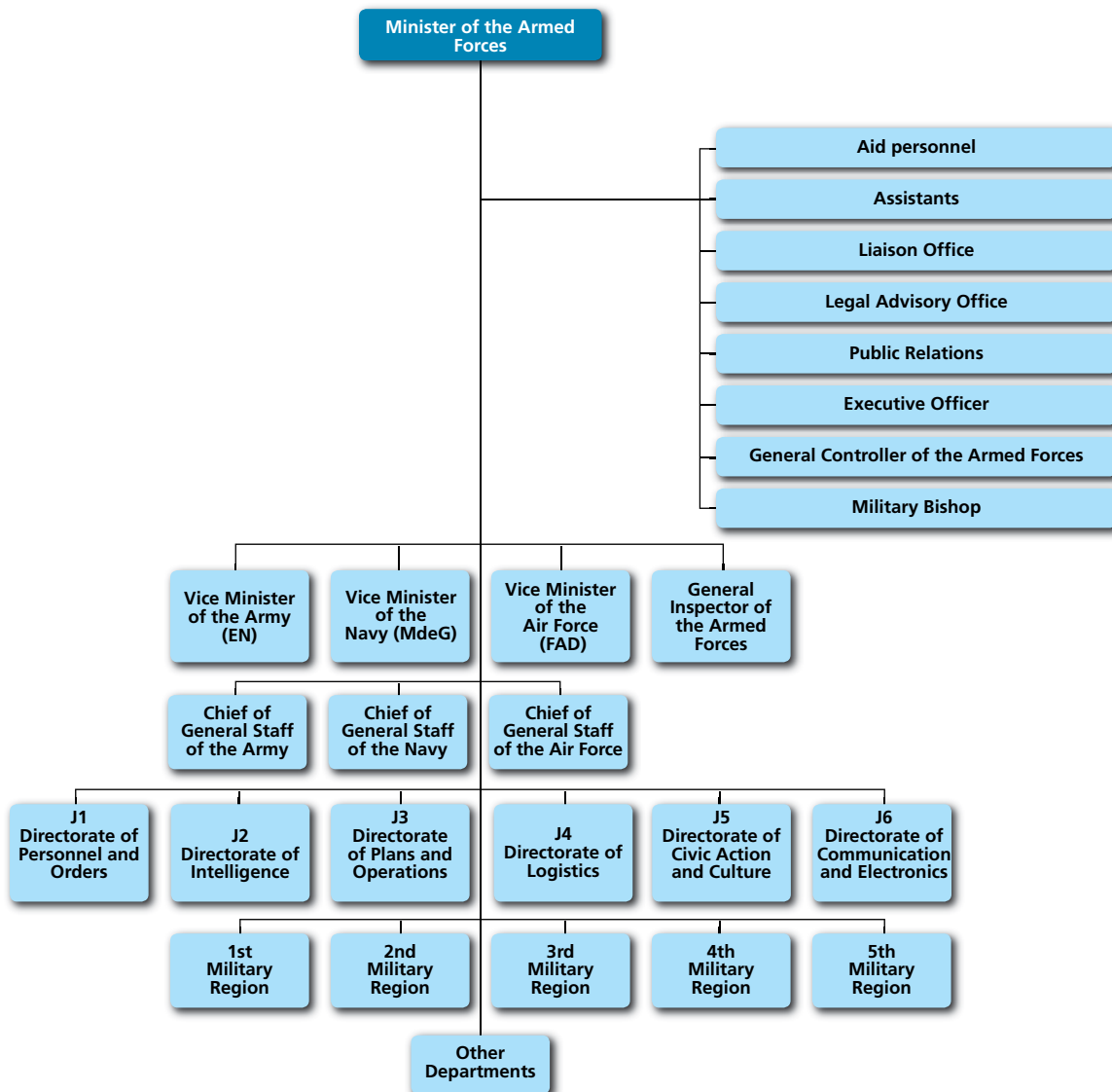

<b>Date of Foundation:</b> 1930
<b>Current Minister (September 2010):</b> Joaquín Virgilio Pérez Feliz
<b>Can military members be Ministers of Defence?:</b> Yes
<b>Number of military members who were Ministers of Defence:</b> 36
<b>Number of civilians who were Ministers of Defence:</b> 3
<b>Have there been any women in charge of the Ministry of Defence?:</b> No
<b>Average stay in the Minister of Defence position:</b> 2 years and 1 month

[The Minister currently in charge is not considered. The creation date is related to the moment in which the term "Defence" becomes part of the Institution's name]

Source: Compilation based on information provided by the website of the Ministry of the Armed Forces.

**Political Definitions**

**Policy Guidelines**

The Armed Forces of the Republic, when developing their mission, shall have an essentially defensive character. The Dominican Republic is placed within the international community as a sovereign and democratic country which acts in the defence of its national interests and consistently with international law principles, efficiently managing cooperation for development and promoting a peaceful coexistence, sustainable global development and a more equitable international order. The specific purpose of the 2010-2013 “National Security and Peace” strategic priority is to guarantee the defence of national security interests by strengthening the national security system. This is achieved by modernizing Armed Forces’ organization and performance in order to guarantee troop skills, professionalization, transparency, loyalty and respect for civil authorities and citizens.

**High priority constitutional objectives**

1. Fight transnational criminal activities which endanger the interests of the Republic and its inhabitants.
2. Organize and maintain efficient systems that prevent or mitigate damages caused by natural and technological disasters.

**Guidance for Defence Policy Development**

- a) National sphere:
  - Definition and identification of national objectives.
  - Enactment of a security and national defence law.
  - Amendment of the Organic Law of the Armed Forces, to redefine the mission, responsibilities and organization of their institutions and restructure the powers of the General Staff within the framework of joint operations.
  - Publication of the White Book of Defence and the Manual of the Joint Doctrine of the Armed Forces.
  - Creation of the National Intelligence System
  - Strengthening of the Standing Committee for Armed Forces Reform and Modernization.
  - Definition of the Armed Forces model and promotion of its transformation.
  - Development of a new institutionalization and professionalization model, based on quality and specialization, consistent with the new technological and organic needs of the modern armed forces, that promotes a mentality change in order to adapt to and understand new roles and missions.
  - Military career reform
  - Equipment upgrading based on budget possibilities to increase the operational efficiency of the Armed Forces, in accordance with the reform and modernization programmes under way.
  - Promotion of research, development and innovation to keep an adequate technological level.
- b) International sphere:
  - To promote and support security and defence policies issued by regional and world organizations adhered to.
  - To strengthen close friendship relations and cooperation with neighbouring nations, particularly with the Republic of Haiti and Caribbean and Central American nations.
  - To contribute to the improvement of security and control in the Caribbean.
  - To reinforce the traditional cooperation links with the United States.
  - To strengthen security and defence relations as well as military cooperation with South American countries and the rest of North America.
  - To increase defence diplomacy.

**General Guidelines for Action**

- Consolidation of the role of the Armed Forces and public security bodies as the essential elements to preserve and maintain peace and stability in the Dominican State.
- Ongoing reform and modernization of the Armed Forces and public security bodies.
- Firm and determined support of an efficient multilateral system as a means to solve conflicts while fully complying with OAS and other related organization resolutions.
- Active involvement of the civil society in major security and defence policy issues, as well as Armed Forces participation in national development plans.

**Sector-Based Objectives**

- To implement joint, inter-agency, development support and civil-military operations which are part of permanent surveillance, security and control mechanisms along the frontier and in formal points of entrance, whether at the land, coastal, sea border and national airspace:
  - o To increase the number of operations of the forces operating at or assigned to such areas or points, including coasts, territorial sea and the airspace.
  - o Total coverage of geographic points and areas in relation to the information gathered by different means (mostly technological), applied by the military intelligence subsystem.
- To increase the number of actions supporting the fight against drug trafficking, organized crime and other emerging threats which are declared to be a high priority.
  - o Increasing the number of ground, sea and air interceptions as well as other operations at the national level.
- To promote the design and development of civil protection operations.
  - o Expansion of preventive, and search and rescue operations.

**Source:** Political Constitution, *Plan Nacional Plurianual del Sector Público 2010-2013* and *Directiva de Seguridad y Defensa Nacional* (Decree N° 189-07 – 2007/04/03).

The Dominican Republic published the *Directiva de Seguridad y Defensa Nacional* in 2007.

**Reports Submitted to the United Nations and the OAS**

1997	1998	1999	2000	2001	2002	2003	2004	2005	2006	2007	2008	2009
	✘	✘										
			◊		◊							

Register of Conventional Arms: ✘ Register of Military Expenditures: ◊ Implementation of Confidence and Security Building Measures: ●

**Source:** Compilation based on reports submitted to the United Nations Register of Conventional Arms and the United Nations Instrument for Reporting Military Expenditures and reports submitted to the OAS on the Implementation of Confidence and Security-Building Measures.



**Military Career**

**Commissioned Officers' Career Path <sup>1</sup>**

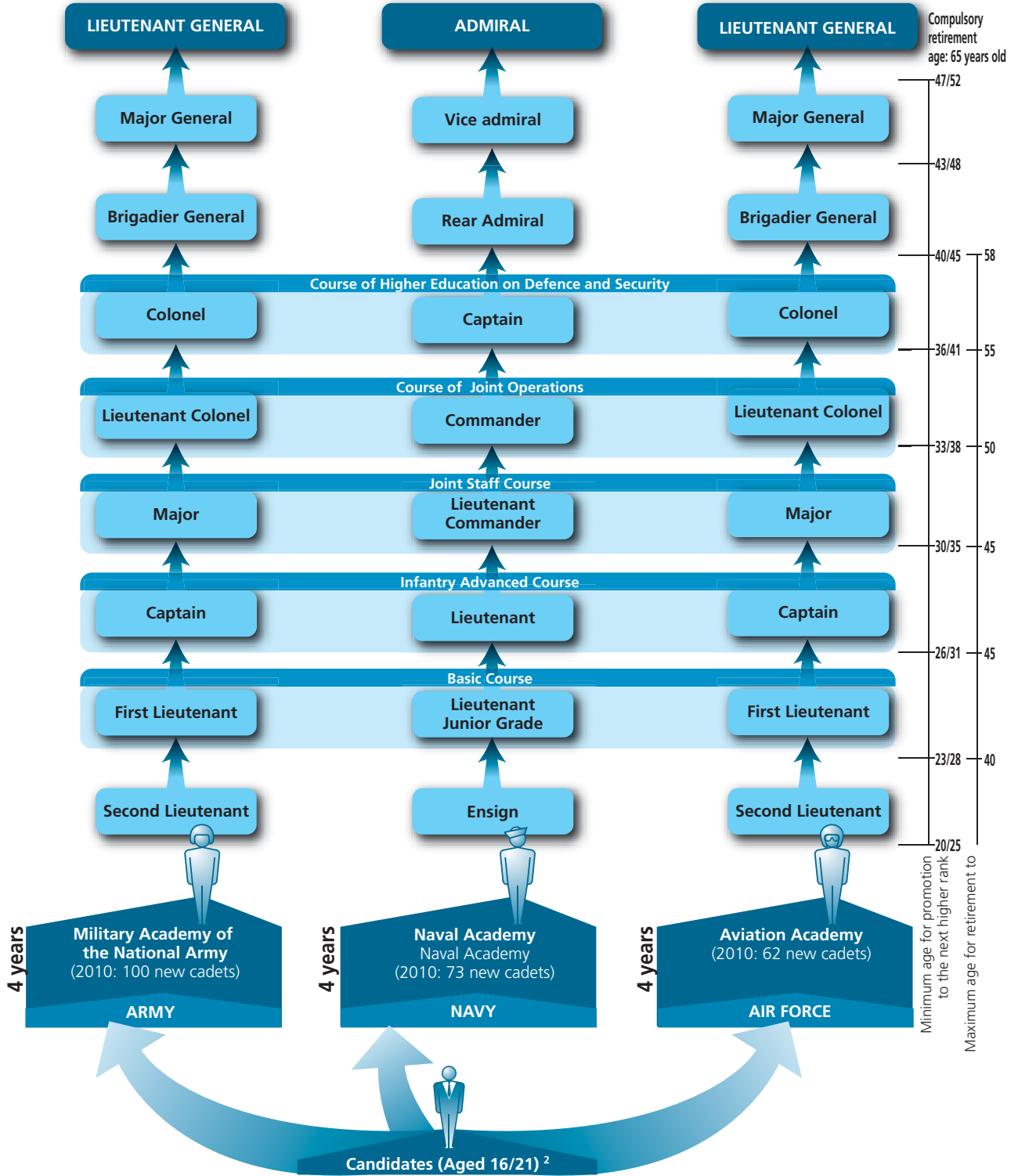

<sup>1</sup> Command corps includes officers who have been educated at military academies from the beginning of their professional careers. The graph makes a theoretical reconstruction of officers' promotion through the completion of mandatory courses. Further requirements for promotion have not been considered.  
<sup>2</sup> The ages of 16-21 have been considered for comparative purposes. Entry age varies depending on the service. The minimum age for promotion shall depend on the age of graduation from the military institution.

**Source:** Compilation based on *Ley orgánica de las Fuerzas Armadas* (Nº 873 – 1978/08/08). New cadets : Information provided by Education Directorate of the Armed Forces.

**The Armed Forces**

**General Mission**

The mission of the Armed Forces is to defend the independence and sovereignty of the Republic, the integrity of its geographic spaces, the Constitution and institutions of the Republic. The Armed Forces shall intervene, whenever the Executive orders, in programs devoted to promoting social and economic development of the country, mitigating disaster and public calamity situations, aiding the National Police in maintaining or restoring public order in exceptional cases. (Constitution, Sec. 252)

**Specific Missions**

**Army**

- Defend the integrity, independence and sovereignty of the Nation.
- Ensure compliance with the national constitution and laws in force.
- Maintain public order.
- Protect traffic, industries and legal trade.
- Support legally constituted authorities and officials, in accordance with the laws and military regulations in effect.
- Protect the people and their assets.
- Perform military service roles assigned by the President of the Republic.

**Navy**

- Defend the integrity, independence and sovereignty of the Nation.
- Ensure compliance with the national constitution and laws in force.
- Support legally constituted authorities and officials, in accordance with the laws and military regulations in effect.
- Maintain public order in the coasts and territorial waters of the Republic.
- Protect shipping and legal maritime industries, enforcing their interests and institutions.
- Combat acts of piracy, violation of laws, regulations on shipping, trade, fishing and international treaties.
- Protect the people and their assets.
- Perform military service roles assigned by the President of the Republic.

**Air Force**

- Defend the integrity, independence and sovereignty of the Nation.
- Ensure compliance with the national constitution and laws in force.
- Support legally constituted authorities and officials, in accordance with the laws and military regulations in effect.
- Maintain public order in the air space of the Republic.
- Protect legal air traffic and trade, enforcing its interests and institutions.
- Combat acts of piracy, violation of laws, regulations on shipping, trade, fishing and international treaties.
- Protect the people and their assets.
- Perform military service roles assigned by the President of the Republic.

**Total Strength: 46,172**

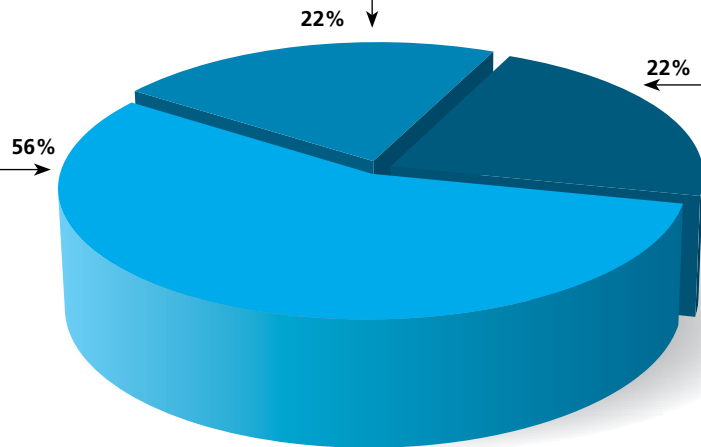
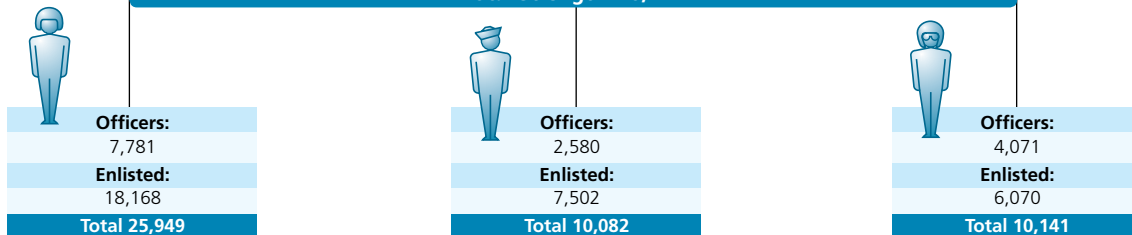

Source: Ley orgánica de las Fuerzas Armadas (Nº 873 – 1978/08/08) (missions) and information provided by the Ministry of the Armed Forces (regular force).



**Women in the Armed Forces**

**Women's Admission to the Armed Forces (year)**

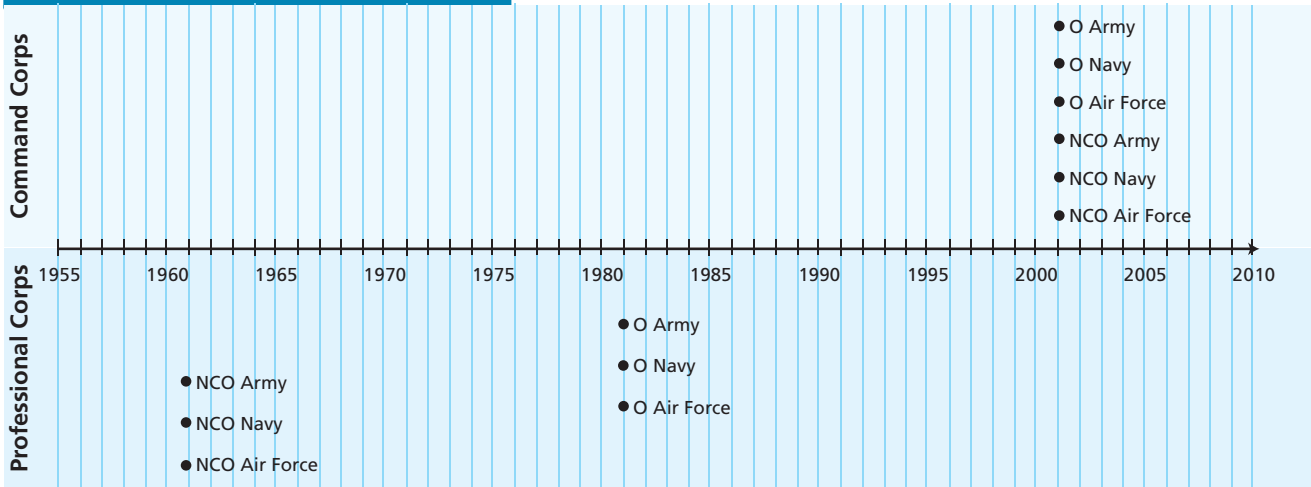

O: Officers - NCO: Non-commissioned Officers

**Note:** The Command corps includes officers who have been educated at military academies from the beginning of their professional careers. The Professional corps refers to those who develop a career in the civilian sphere and are then incorporated to the armed forces.

**Women Officers who have reached the highest rank in the Command Corps (2010)**

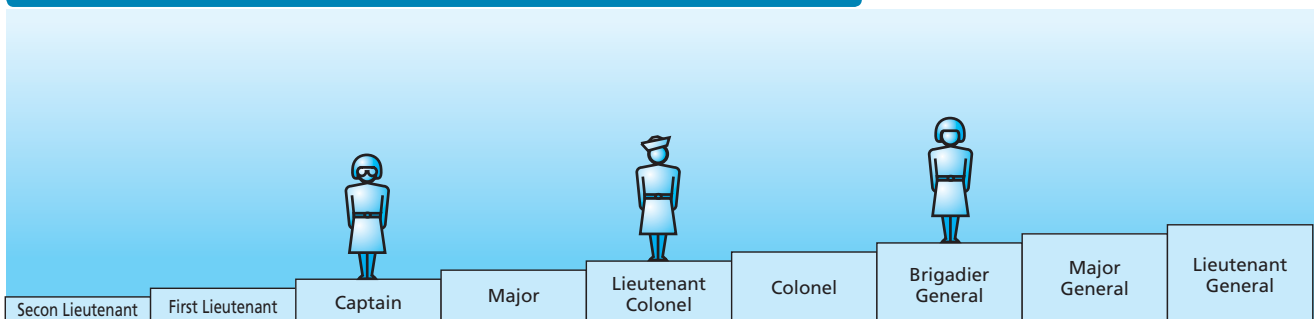

**Note:** These ranks correspond to the Army, as an example. The equivalent ranks for lieutenant Colonel are Commander (Navy) and Captain (Air Force).

**Source:** Project 07-184 Global Peace and Security Fund-Resdal.

**Military Service**

Military service is voluntary for all Dominican people and provides for a 4-year duration.

A special training programme is available for high-school young citizens on Saturdays with a three-month duration.

		Special training programme		
		Men	Women	TOTAL
2009	6th class	816	846	1,662
	7th class	886	917	1,803
2010	8th class	791	834	1,625

**Total number of young students who joined the programme since its creation: 16,677.**

**Source:** Information provided by the Ministry of the Armed Forces and *Ley orgánica de las Fuerzas Armadas* (N°873 – 1978/08/08).

**Defence and National and International Community**

**Support Actions**

The Armed Forces regularly conduct community support activities, thus contributing to national development and environmental protection. Examples of activities:

<b>April 2009</b>	The Army and the Ministry of Environment and Natural Resources started Operation Reforestation in the littoral region between Santo Domingo and the province of Santiago.
<b>August 2009</b>	The Ministry of the Armed Forces, in coordination with the Ministry of the Environment and Natural Resources, conducted a reforestation campaign in Juan Bosch hill.
<b>September 2009</b>	The National Army distributed over 500 backpacks filled with a complete set of school supplies and an equal number of food rations.
<b>April 2010</b>	The Ministry of the Armed Forces held the Conference on National Development Strategies on April 14, presided by the Minister of Economy and Development.
<b>June 2010</b>	The Ministry of the Armed Forces and Ministry of Youth signed a cooperation inter-agency agreement to encourage young people to join the volunteer military service.
<b>October 2010</b>	The Ministry of the Armed Forces and Ministry of the Environment and Natural Resources signed an agreement, the so-called Forest Plan, in which they reaffirmed their commitment to work towards the preservation and rational use of natural resources with a focus on forests and protected areas.

**Centre of Maritime Operations**

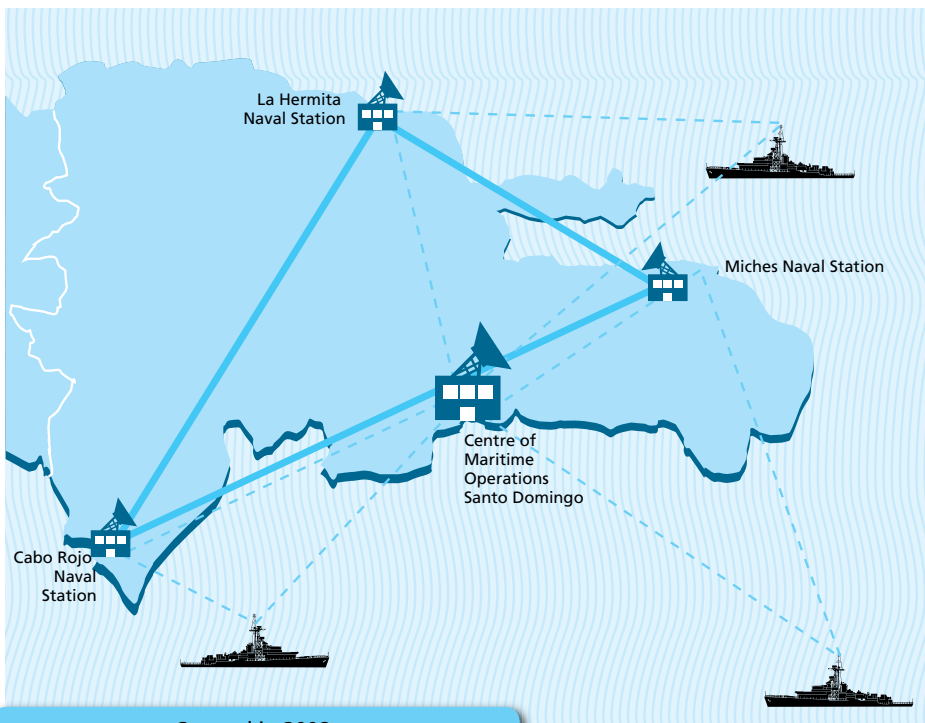

The Dominican Republic is part of the CNIES (Cooperating Nations Intelligence Exchange System) which receives real time air-space satellite information supplied to the Centre.

All fast boats are in contact with the Centre of Maritime Operations (Centro de Operaciones Marítimas, COM), one of the achievements that has raised the effectiveness in the monitoring and enhanced exchange of information to protect national security among other key objectives.

Created in 2008. It operates a national and international cooperation network which shares naval intelligence information. US Coast Guard Service, San Juan Sector, Puerto Rico and the Navy of the Republic of Colombia.

Missions (March 2009 – February 2010)	TOTAL
Boardings	37
Search and Rescue	73
Counter-narcotics in support to the National Drug Control Directorate	164
Maritime security (escort)	91
Environmental protection and support to the national shipping sector	233
Scientific research (oceanographic)	18
Combat of illegal shipping	154
Support to "DEPROSER" Joint Task Force	38

Source: Compilation based on information provided by the websites of the Armed Forces and *La Marina de Guerra del Nuevo Milenio, Memoria 2009*.





Analisis:

## The Impact of Constitutional Changes

### Josefina Reynoso Chacón

*Coordinator of the Center for National Security and Defence Studies, Funglode.*

The year 2010 will be a landmark in defence and security matters for the armed and police forces in Dominican Republic, as the civilian power exercised by lawmakers has clearly addressed the subject, thus allowing the consolidation of these institutions looking forward.

Since the inception of the Dominican State in 1844 (with the first Constitution proclaimed on November 6 of the same year) until this date, the Magna Carta has undergone twenty-five reforms, twelve revisions and an additional statute, i.e. thirty-eight transformations in the aggregate.

For the first time in this process, the Constitution has now a special section and title on security and defence matters that clearly states the mission and roles of the armed forces and security institutions, opening the doors to a new story line where the system will end up strengthened.

It was thus how the creation and consolidation of a new system capable of interrelating State elements is initiated, for the purposes of guaranteeing national defence and security through the planning, conduct, implementation and oversight of public policies related to the matter. In this system civilian power is represented by the President, as the maximum authority in his capacity as Chief of State and General Com-

mander of the Armed Force, who is in charge of the conduct of all aspects related to the nation's defence, translated into the policy and conduct of the forces.

Titles XII and XIII of the Constitution are comprised of three chapters and fifteen articles outlining the armed forces' mission and characteristics, the military and police careers, the competencies and disciplinary systems, the creation of new bodies, including the National Defence and Security Council, high-priority objectives, the states of exception and their regulations.

A point worth of note, very clearly stated in this Constitution, is the definition of the armed forces roles (the defence of the nation) and of the National Police (safeguarding citizens' security).

It also prohibits the reincorporation of its members, allowing it only in the event that, after the appropriate investigation, it is proved that there has been a violation of the organic law in the act providing for their retirement. This is an important element as many governments have arbitrarily used their then existing reinstatement powers, making of Dominican Republic one of the countries with the largest number of active generals.

The provisions on the military and police career are equally worth of note: a new organic act for each one

of those institutions is to be passed, where the terms of promotion are to be established as well as the termination of the professional career, which shall not exceed 35 years of service or 65 years of age.

Although public and citizen security continues to be under charge of the Ministry of the Interior and the Police, the National Police now reports directly to the President of the Republic as mandated under article 255 of the National Constitution.

A new *National Defence and Security Council* has been created as a consulting body to advise the President, similar to those existing in other countries including the United States, Brazil or Peru, to name just a few. The Council's composition and operation must be regulated in the near future. Taking other legislations as reference, the Council is proposed to be the main integration and coordination body; to be oriented to preserving national security and defence; to be knowledgeable of the guidelines allowing the establishment of general policies; to define the national risk agenda and regularly assess their results. In addition, it shall be involved in the acquisition of strategic military equipment for defence, seeking to standardize, within the specifics for each service, the equipment of the whole military institution.

The foregoing leads to the encompassing changes that need to be implemented in the short term for the defence and security instances, including:

- Making up a new *defence and security system* that could bring about its transformation as a Ministry of Defence, with a new structure, with capacity to have the difference between the political function and the military functions clearly defined and which shall be supplemented with the passing of a Defence and Security Act and the nomination of a civilian Minister. The system would be comprised of all the State elements oriented to guaranteeing national security and defence; their function would be to provide guidelines for the purpose of articulating the operations of competent agencies, prioritizing their functional relations. Also, the development of strategic planning capable of identifying potential threats in various scenarios.

- Restructuring the current national intelligence system which -- of course-- needs to be regulated by an intelligence act. The intelligence agency shall focus on generating intelligence and counter-intelligence, enabling it to identify threats and prevent internal and external conflict.

- Cooperating with the national civil defence system, where the armed forces, police and other institutions are, by their own nature, capable of contributing to security and wellbeing in the event of emergency situations. They are in fact the organizations with the necessary training and equipment, as was demonstrated after January 12, 2010 with the Haitian Republic's tragedy.

- The National Defence and Security Council Monitoring Directorate, to name just one that is clearly mentioned in Decree 189/07, should assume the function of promoting an effective coordination and operation of the Council. It should be a permanent agency headed by a professional Director specialized in the matter for administrative and technical support. The mentioned Decree which, in 2007, established the National Security and Defence Directive, highlights the need of developing policies and establishes certain functions including the publication of a White Paper on Defence. Said book would be geared to defining, within a designated time, the specific objectives of the state's defence policy.

The Constitution also establishes that the President may request from the Congress the establishment of *Public Security Corps* or *Defence Corps*, made up of Armed Forces or National Police members and subordinated to the respective competent ministry.

States of Exception are dealt with under Title XIII. They are defined as extremely grave events that call for the vesting of extraordinary powers for a certain specified period. Three situations are provided for: the state of defence, the state of internal commotion and the state of emergency; also set forth are the rights to be safeguarded during those states of exception.

Security and defence are at present related to sustainable development and hence, this notion must underlay every public policy where coordination, execution and vigilance mechanisms between State and society must be ensured.

New changes are to be expected in institutions, in a process seeking closer civilian-military relations where non-state actors will be consolidated for national defence and security. In this context, actions towards transparency and confidence building will need to be taken so that defence and security institutions can gain a new and enhanced position in public opinion.



# Ecuador

## The Legal Framework and the Defence System

### National Legislation

#### Systems and Concepts

- Organic Act for National Defence (N° 74 - 2007/01/19, Last amendment: Act N° 35 - 2009/09/28)
- Act of Public and State Security (N° 35 - 2009/09/28)

#### Military Organization

- Penal Military Code (Codification N° 27 - 1961/11/06)
- Code of Penal Military Procedures (Codification N° 28 - 1961/11/06)
- Act of Armed Forces Personnel (1991/04/10, Last amendment: 2009/06/08)
- Social Security Act for the Armed Forces (N° 169 - 1992/08/07, Last amendment: 2009/03/30)

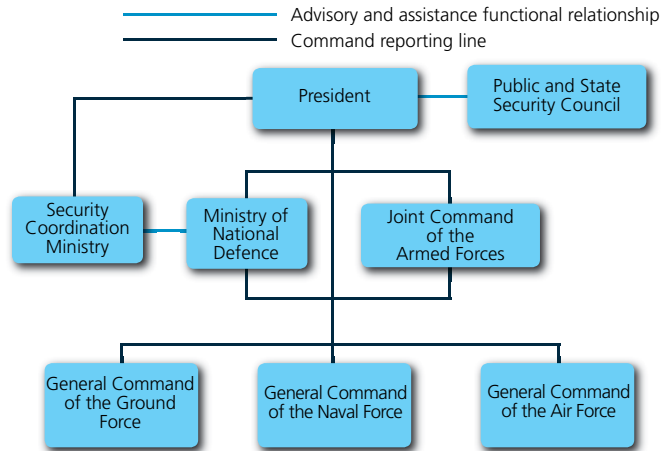

The President may request the advice of the Public and State Security Council, composed of the Vice President, the Presidents of the National Assembly and the National Court of Justice, the Ministers of Coordination for Security, Defence, Government, Police and Religion, Foreign Affairs, the Chief of the Joint Command of the Armed Forces and the General Commander of the Police. The Ministry of Coordination for Security is responsible for the global planning and coordination of the bodies that make up the Public and State Security System. The Ministry of Defence is the political, strategic and administrative organ of national defence. The Joint Command of the Armed Forces is the highest organ of planning, preparation and strategic conduction of military operations. The Assembly holds the powers granted by the Constitution and permanently monitors defence related issues through the specific committee.

**Source:** Compilation based on the legislation above mentioned. For constitutional provisions see Chapter 1.

**Source:** Compilation based on *Ley orgánica de la defensa nacional* (N° 74- 2007/01/19. Last amendment: Act N° 35 - 2009/09/28), and *Ley de seguridad pública y del Estado* (N° 35 - 2009/09/28).

## The Budget

Year	Defence budget (in US\$)	Government budget (in US\$)	GDP (in US\$)
2006	953,125,534	11,761,874,717	33,871,000,000
2007	1,168,229,152	14,908,339,359	44,528,000,000
2008	1,389,330,906	15,817,954,065	49,597,000,000
2009	1,679,073,897	19,167,809,880	55,613,000,000
2010	2,156,832,116	21,282,062,279	61,958,000,000

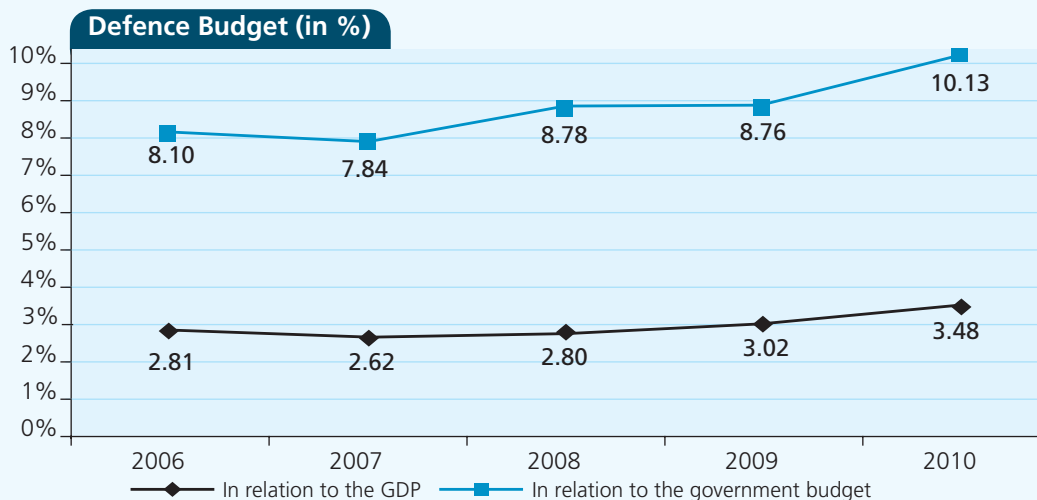

**Defence Budget Breakdown**

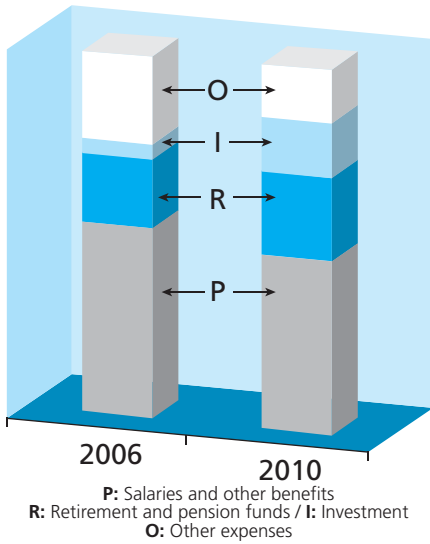

**Comparative Increase (% variation 2006-2010)**

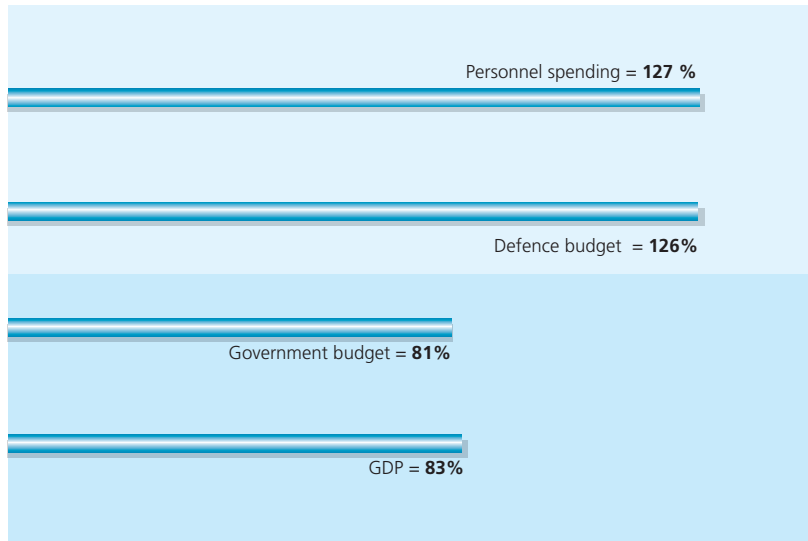

**Defence Budget 2010 (in Local Currency - US\$)**

Sectors	TOTAL
<b>National Defence</b>	
Ministry of Defence	1,511,483,579.18
National Security Council	1,986,757.05
Military Geographical Institute	21,114,761.60
Remotely Sensed Integrated Information Gathering of Natural Resources	3,144,181.37
General Hospital of the Armed Forces N°1	29,898,896.38
Pan American Institute of Geography and History	511,383.16
Ecuadorian Institute of the Antarctic	799,602.62
Intelligence Secretariat	6,760,524.64
<b>Jurisdictional</b>	
Court of Military Justice	797,848.92
<b>Education</b>	
Higher National Studies Institute	11,027,799.76
Polytechnical School of the Army	48,371,814.74
<b>Social Security</b>	
Social Services Institute of the Armed Forces *	520,934,967.00
<b>TOTAL</b>	<b>2,156,832,116.42</b>

\* It excludes financial investment and self-management budgets from ISSFA.

**Composition of Defence Budget**

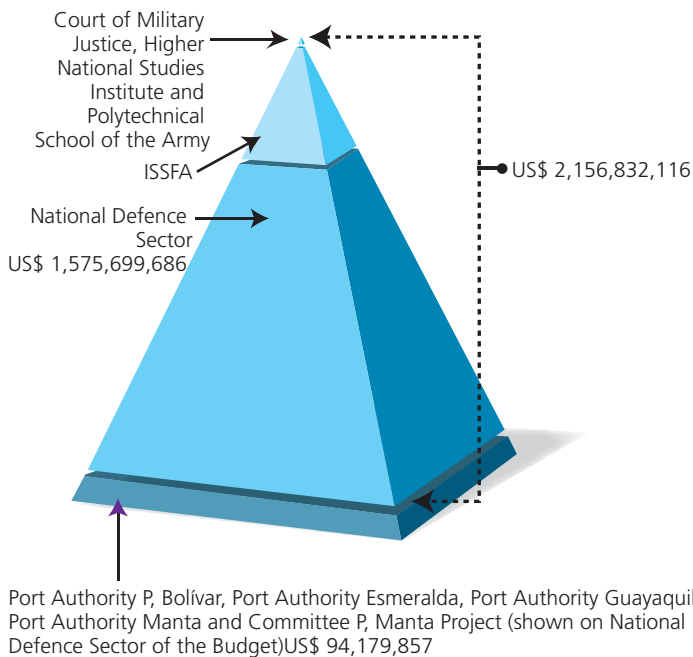

The annual capital investment programme for financial year 2010 allocates 298 million dollars to Defence sector projects. As much as 91% of those funds are programmed for infrastructure, operational capability-building and equipment upgrades, among others. The remaining 9% (27 million) is to be destined to medium-sized and other light helicopter acquisitions as well as transport and training aircraft.

**Source:** Compilation based on *Ley de presupuesto general del Estado* 2006, 2007, 2008, 2009 and 2010. The State Budget passed by the Congress by means of the above mentioned Act is considered herein. The concept of investment is that expressed in "Annual investment plan".  
 GDP: Projection of the World Economic Outlook Database, IMF, of each year under review. This source has been taken for comparative purposes. Each country prepares the budget based on its own GDP estimation.  
 Expressions in Bold Type (Table) make reference to the various defence budget items, which can be found in a sector-based or institutional classification of the Budget Act.



**The Ministry of National Defence**

**Responsibility:**

It is the political, strategic and administrative body of national defence.  
(Ley Orgánica de la Defensa Nacional, N° 74 – 2007/01/19, Sec. 8).

**Organization Chart and Personnel**

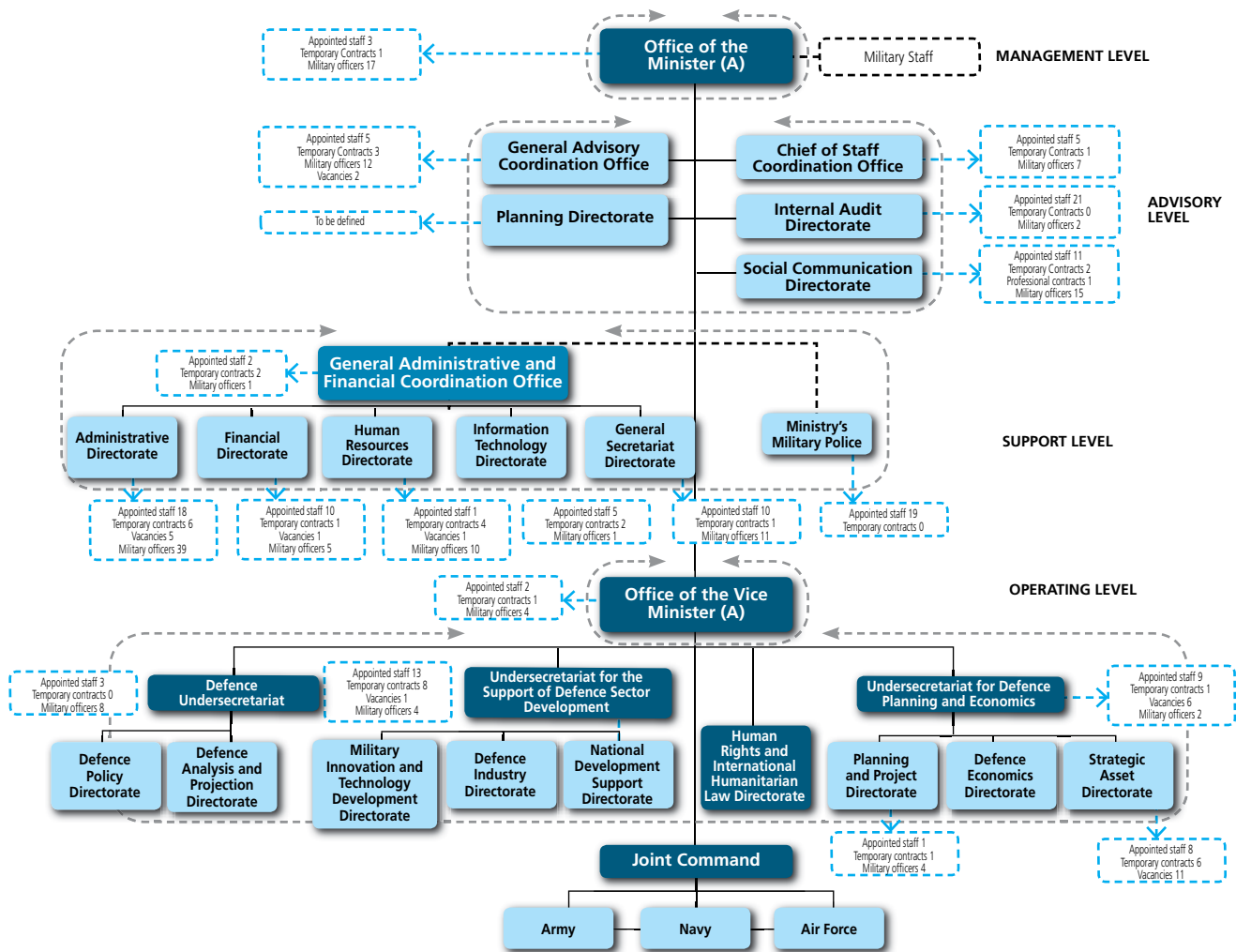

<b>Date of Foundation:</b> 1935
<b>Current Minister (September 2010):</b> Javier Ponce Cevallos
<b>Can military members be Ministers of Defence?:</b> Yes (if they have retired)
<b>Number of military members who were Ministers of Defence:</b> 33
<b>Number of civilians who were Ministers of Defence:</b> 20
<b>Have there been any women in charge of the Ministry of Defence?:</b> Yes (Guadalupe Larriva 2007 and Lorena Escudero 2007)
<b>Average permanence in the Minister of Defence position:</b> 1 year and 5 months

[The Minister currently in charge is not considered. The creation date is related to the moment in which the term "Defence" becomes part of the Institution's name]

Source: Compilation based on information provided by the Ministry of National Defence.

**Political Definitions**

**Policy Guidelines**

**Defence Policy Principles**

Ecuador is a sovereign nation, respectful of international law principles, which promotes the settlement of disputes through legal and peaceful means, condemns the use of threat and force to resolve conflicts and advocates cooperation and integration for international development and security, with a special focus on the South American Region.  
Ecuador has a defensive strategy with a proactive orientation. It is based on early warning, prevention and, as a last resort, the use of force as a measure of deterrence and defence against any type of aggression or threat. At the same time, it seeks to collaborate with the international community in keeping international peace and security within the framework of standing agreements including, most especially, the UN Charter.

**Strategic Objectives**

1. To exercise an effective control of the national territory, its water spaces, territorial sea and air space.
2. To protect the Nation's people, resources and assets.
3. To prevent and defend the country against any type of aggression.
4. To assist in emerging issues, natural disasters and crisis situations.
5. To cooperate with the international community on international peacekeeping and security, within the UN framework.
6. To develop trained human talent committed to institutional and national interests.
7. To implement an integrated system of research and development.
8. To achieve a sustainable economy for defence.

**Agenda Highlights**

Ecuador published the *Política de la Defensa Nacional del Ecuador* (National Defence Policy of Ecuador) in 2002 and 2006 and the *Agenda Política de la Defensa Nacional* (Political Agenda of National Defence) in 2008.

**1. Political Element**

- Assessment and updating of the national defence policy.
- Updating of the Armed Forces legal framework in accordance with the Constitution of the Republic of Ecuador and laws in force.
- Integration of the relevant defence agenda contents in the inter-agency cooperation processes.
- Administrative reorganization of the Ministry of National Defence.
- Strengthening of transparency and accountability of the organization's activities and of its responsibility in accomplishing its mission.
- Continuation of the "military citizen" professionalization process and the promotion of personnel wellbeing, as well as that of their family, with a criterion of equity and responsibility.
- Consideration of military personnel as full citizens, regulating the military personnel's right to vote and the defence of their human rights.
- Reinforcement of the Armed Forces' institutional image to the citizens, focusing on their modernization, peace building and human security promotion.
- Completion, in the shortest time possible, of all pending commitments assumed in the Peace Agreement of Brasilia, 1998.
- Carrying out of an integral security strategy for the Northern border, in order to maintain a State presence, based on the respect of international law principles and interagency cooperation, as well as in accordance with international agreements, the Plan Ecuador, and the enhancement of Armed Forces operational capacity.
- Promotion of a national methodology to define the security and defence policy, in coordination with other State agencies.

**2. Military Element**

- Update of the Strategic Plan of the Ministry of National Defence.
- Institutional strengthening and improvement of operational, logistic and administrative capacity of the Armed Forces, in order to exercise an effective control of the territory.
- Strengthening of civil-military relations, promoting citizen involvement and cooperation in the defence and assistance in emergency events, crises and natural disasters.
- General military service reform, in order to promote the civic and patriotic values in the citizens.

**3. Support to Development**

- Involvement and contribution to execute institutional plans which allow improving the population's life quality and State security, under sustainability and human security criteria.
- Consolidation of civil-military relations, especially with vulnerable population, and particularly in the border areas, through the Armed Forces contribution to development.
- Support to Government bodies to execute their political plans and guidelines.
- Reinforcement of national maritime and fluvial development.
- Intensified efforts in planning, technological innovation development and promotion of new technical directions, contributing to attain a competitive advantage -at national and regional levels- for military institutes and industries.

**4. Cooperation and International Relations**

- Strengthening, development and diversification of Ecuador's involvement and presence in peacekeeping operations and humanitarian aid, within the framework of international agreements.
- Enhancement of cooperation and coordination of defence policies in the regional and hemispheric spheres, as well as implementation of measures to promote confidence building.
- Update of international commitments.
- Positioning in the hemispheric and regional arenas, conveying the country's thoughts on defence and security.
- Ongoing training of the Armed Forces and update of their expertise on human rights and International Humanitarian Law.
- Progressive inclusion of cross-functional areas such as international protection, migrant rights, environmental issues and prevention/reduction of natural disasters, among others.
- Support to the creation of the South American Defence Council.

Source: *Agenda Política de la Defensa Nacional*, 2008.

**Reports Submitted to the United Nations and the OAS**

1997	1998	1999	2000	2001	2002	2003	2004	2005	2006	2007	2008	2009
	✘	✘	✘	✘	✘	✘		✘				
◊			◊	◊	◊	◊	◊	◊	◊	◊		
✱					✱							

Register of Conventional Arms: ✘ Register of Military Expenditures: ◊ Implementation of Confidence and Security Building Measures: ✱

Source: Compilation based on reports submitted to the United Nations Register of Conventional Arms and the United Nations Instrument for Reporting Military Expenditures and reports submitted to the OAS on the Implementation of Confidence and Security-Building Measures.



**Military Career**

**Commissioned Officers' Career Path<sup>1</sup>**

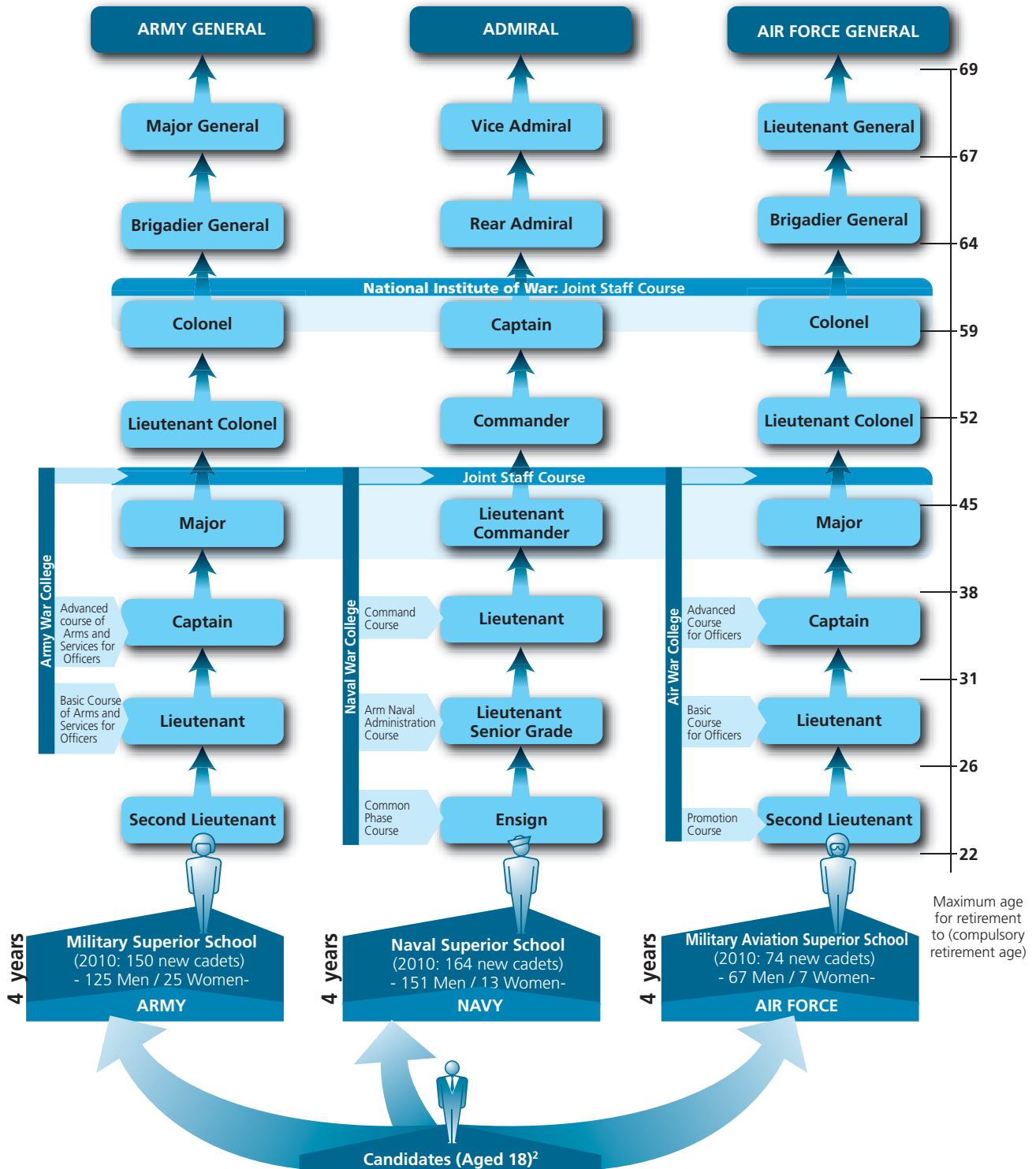

<sup>1</sup> Command corps includes officers who have been educated at military academies from the beginning of their professional careers. The graph makes a theoretical reconstruction of officers' promotion through the completion of mandatory courses. Further requirements for promotion have not been considered.

<sup>2</sup> The age of 18 has been considered for comparative purposes. Entry age varies depending on the services: Army 18-22 years old, Naval Force 18-21 years old, Air Force 16-21 years of age.

**Source:** Compilation based on *Ley del personal de las Fuerzas Armadas* (10/04/1991 Last reform: 08/06/2009) and web pages of the above mentioned institutions. New cadets: Information provided by the Ministry of National Defence.

### The Armed Forces

#### General Mission

The Armed Forces shall have the fundamental mission to preserve national sovereignty, defend the integrity and independence of the State, and guarantee its legal order.  
(Constitution, Art. 158)

The Armed Forces, as part of the public forces, have the following mission: maintain national sovereignty, defend the integrity, the unity and independence of the State; and guarantee the legal and democratic order of the social rule of law. Moreover, they shall collaborate with the social and economical development of the country; they can participate in economical activities exclusively related with the national defence; and, intervene in the rest of the aspects regarding national security, in accordance with the law.  
(*Ley orgánica de la defensa nacional*, N° 74 – 2007/01/19. Last amendment: Act N° 35 – 2009/09/28, Art. 2)

#### Specific Missions

##### Army

To develop ground power to attain the institutional objectives while ensuring defence and contributing to the Nation's security and development in order to reach military strategic planning goals.

##### Navy

To organize, train, equip and maintain naval power, as well as to participate in the processes that ensures the country's security and promote its development, for the purpose of contributing to the attainment and maintenance of national goals in accordance with planning for times of peace, conflict and war.

##### Air Force

To develop air military power to attain institutional objectives aimed at ensuring the Nation's defence and contributing to its security and development.

#### Total Strength: 37,184

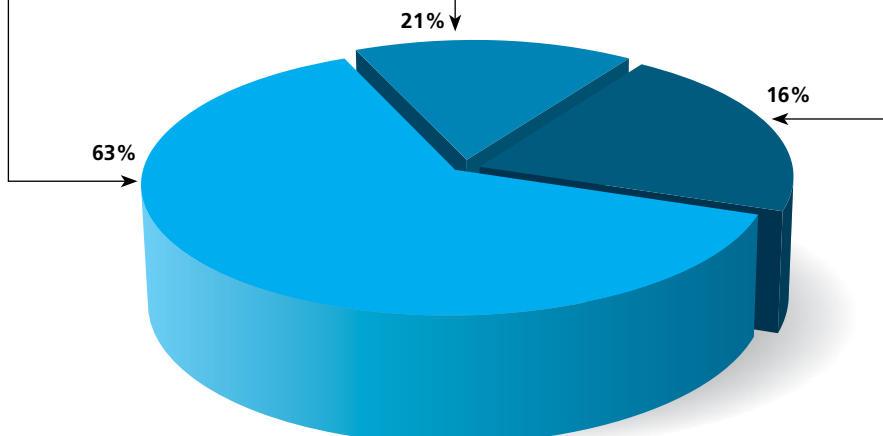
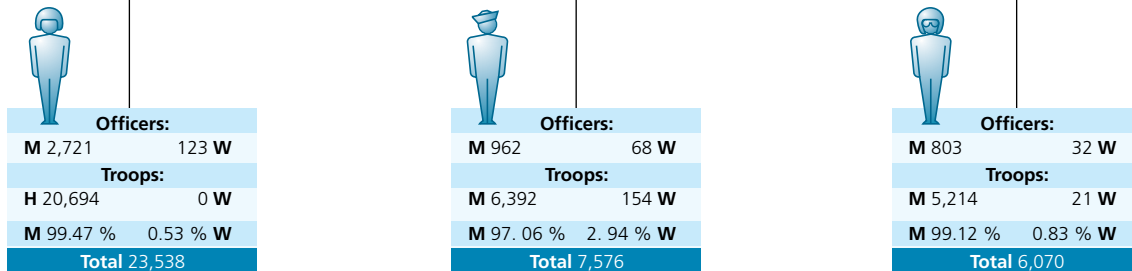

M: Men / W: Women

Source: Website of the Armed Forces (missions) and information provided by the Ministry of National Defence (Regular Forces). In the Ecuadorean System, the term "troops" includes the private rank up to the non-commissioned officer.





**Women in the Armed Forces**

**Women's Admission to the Armed Forces (year)**

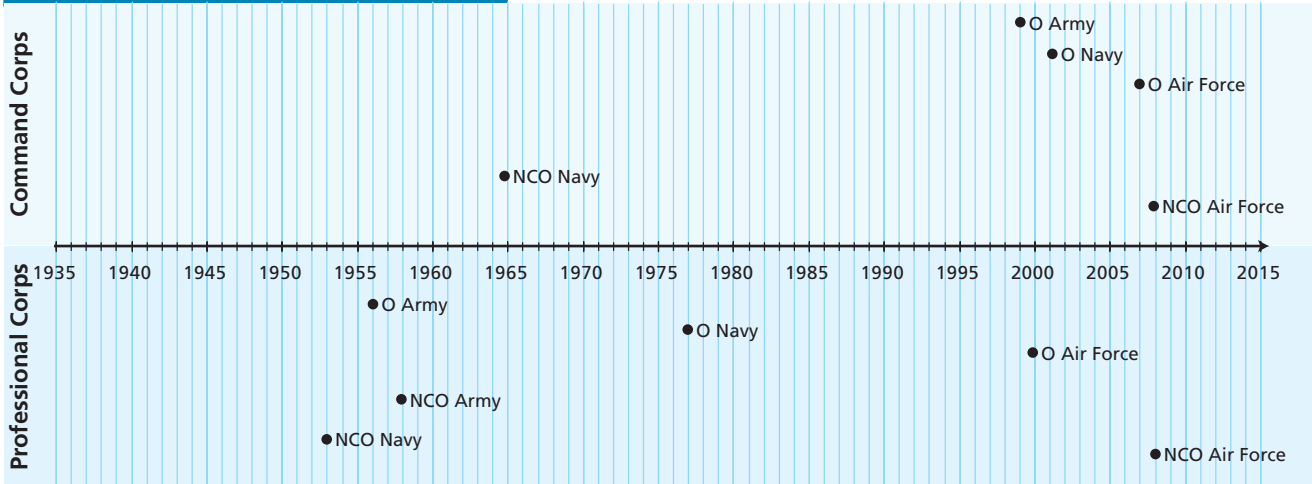

O: Officers - NCO: Non-commissioned Officers

**Note:** NCOs include Army Volunteers, Navy Crew and Air Force Air Technicians. Women do not enter as NCOs to the command corps of the Army. The Command corps includes officers who have been educated at military academies from the beginning of their professional careers. The Professional corps refers to those who develop a career in the civilian sphere and are then incorporated to the armed forces.

**Women Officers who have reached the highest rank in the Command Corps (2010)**

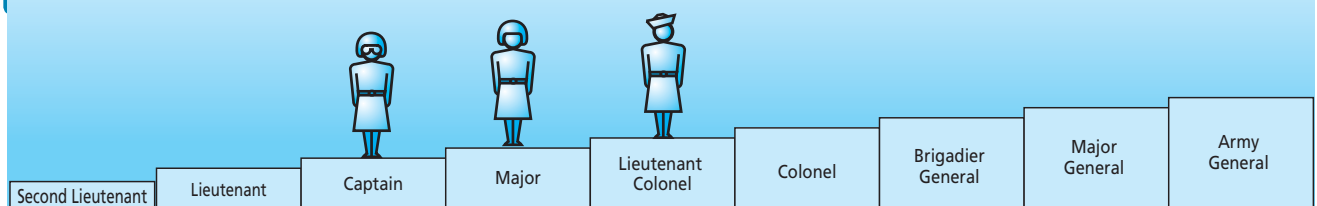

**Note:** These ranks correspond to the Army, as an example. The equivalent rank for Lieutenant Colonel is Commander (Navy) and for Captain is the same (Air Force).

1.07 % (398) of the total Armed Forces are women.

**Source:** Information provided by the Joint Command of the Armed Forces and the Ministry of National Defence, and Project 07-184 Global Peace and Security Fund-Resdal.

**Military Service**

In accordance with the 2008 Constitution, it is voluntary both for men and women for a duration of 1 year.

**Process:**

- Qualification (July to November): to submit to tests assessing the candidate's fitness for military service. It may also occur, as in 2010, that there are individuals who directly appear at the centres after the usual period of qualification, near the quartering stage.
- Quartering: those individuals who were deemed fit and notified, who are concentrated at the mobilization centres for transfer to their destination.

The women's military civic service has not been implemented yet, and there are 18 candidates.

Year of	Number of Qualified and Quartered Individuals						
	Qualification			Quartering			
	Fit	Unfit	Total	1st Call	2nd Call	3rd Call	Total
2009	29,560	2,787	32,347	4,328	5,427	4,850	14,605
2010	15,018	956	15,974	6,900	5,535	5,191	17,626
Total	44,578	3,743	48,321	11,228	10,962	10,041	32,231

**Planning of enlisted troops necessary by region**

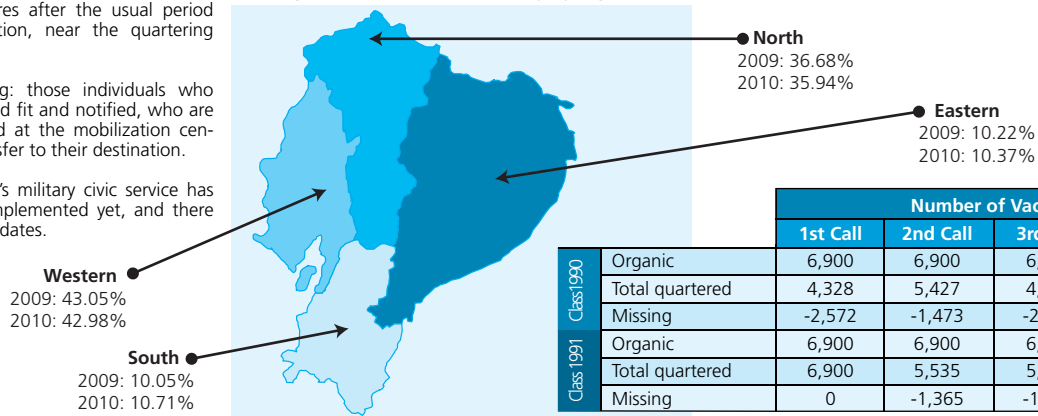

		Number of Vacancies			
		1st Call	2nd Call	3rd Call	Total
Class 1990	Organic	6,900	6,900	6,900	20,700
	Total quartered	4,328	5,427	4,850	14,605
	Missing	-2,572	-1,473	-2,050	-6,095
Class 1991	Organic	6,900	6,900	6,900	20,700
	Total quartered	6,900	5,535	5,191	17,626
	Missing	0	-1,365	-1,709	-3,074

## Defence and National and International Community

### Participation in Peace Operations

Current Missions	Military Component			
	MEM		MC	
	Men	Women	Men	Women
MINUSTAH (Haiti)	-	-	67	-
UNMIL (Liberia)	2	-	1	-
UNMIS (Sudan)	17	-	-	-
UNOCI (Ivory Coast)	1	-	-	-

MEM: Military experts on mission, including military observers, judge advocates and military liaison officers, among others - MC: Military Contingent

**Source:** Compilation based on documents from the Department of Peacekeeping Operations of the United Nations. Data as of 31 August 2010.

The Ecuador Peace Mission School Unit (UEMPE) has been appointed the Regional Centre for training in Humanitarian Assistance within the framework of the Latin American Association of Training Centers in Peace Operations (ALCOPAZ). The course titled "Humanitarian Assistance and Civil-Military Coordination in UN Peacekeeping Operations" is scheduled for November 8 to 19, 2010.

Ecuador contributes 88 military troops to the United Nations peacekeeping missions, which represents 1.15 of the total contribution of Latin America.



## Support Actions (during 2009)

### Participation in the Ecuador Plan

The necessary logistics support was provided by air and security means so that the Plan's Technical Secretariat was able to conduct certain scheduled activities, including visits to health centres and subcentres located in the North Border, rural schools in Agrio Lake and Shushufindi, in order to conduct the refugee census in the provinces of Esmeraldas, Sucumbios and Carchi.

### National Navy

The National Navy and the non-industrial fishing sector have strengthened their relation by seeking to attain the best solutions to address illegal activities at sea. The National Navy, through the Coast Guard, maintains illicit activity monitoring functions, such as: ship inspection and seizure, search and rescue operations, goods and fuel smuggling control and migrant rescue.

### Air Force

- 24 community health actions were conducted (50 troops/ 431 beneficiaries); 3 actions in education (23 troops/ 130 beneficiaries) and 16 community support actions (15 troops/ 2,153 beneficiaries).
- Civic action flights by way of the "Alas para la alegría" (transporting 2,100 children in 2009), "Alas para el desarrollo" (Eastern region), "Alas para la Salud" (sanitary flights) and "Alas para la Educación" (transporting educational material) programmes.

### Infrastructure

- Maintenance of road infrastructure by building and reconstructing roads and bridges.
- Construction of the pier in General Farfan and construction work for the Coca pier to provide loading and unloading port facilities for people and products to the communities.
- Maintenance and dredging works in the Mazar dam, hydraulic filling in Babahoyo and Jujan, Guayaquil Naval Base, access channel for Guayaquil Maritime Port, and Amalusa pond.

### Border Protection

Ten operations related to border protection have been conducted involving 9,250 men and 1,200 flight hours, recording 3 clashes resulting in the seizure of 245 weapons, 11,747 munitions, 90 grenades, 1,646 explosives, 70 kilos of cocaine hydrochloride, 17,250 grams of cocaine sulfate, 15,000 litres of acetone, 4 vessels and 1,250 coca plantations. In addition, the Selva Alegre, La Carolina and Santa Bárbara detachments were set up in order to strengthen border security.

### "Manuela Espejo" Mission

Scientific-medical study to determine the causes of disabilities and know the bio-psychosocial reality of the population from the biological, psychological, social, clinic and genetic perspective, in order to outline State policies covering several areas, such as health, education and social wellbeing. 229 specialist physicians from Cuba and 120 physicians from Ecuador have visited 378,311 homes in Cotopaxi, Imbabura, Esmeraldas, Carchi, Napo, Sucumbios, Manabí and Los Ríos, and recorded a number of 77,200 people with disabilities, who will receive health care under the Response Operation. The Ministry of Defence provides logistic support as well as storage, transport and distribution of aid required by people with disabilities.

### Logistics

Ongoing contribution to the Monteverde Project, for the purpose of reducing the cost of liquefied gas storage and transportation to meet the country's and region's needs.

### Humanitarian Demining

7,640 square meters of territory were successfully demined by eliminating 73 mines.

### Natural Resource Protection

- The Ecuadorean Army started the forestation process in several units and detachments in coordination with and financed by PROFORESTAL.
- The Armed Forces, in coordination with the Ministry of the Environment, conduct tree cutting control activities and localization of wood camps.
- Several operations have been conducted jointly with the Armed Forces and the National Police to prevent illegal mining in the border area of Esmeraldas and Carchi.

### Health Support

- A Joint Medical Brigade was conducted at the Eloy Alfaro de Manta Air Base Clinic, with the collaboration of the "James Carrera" Foundation, conducting 80 surgeries, seeing 300 patients and delivering free medicines.
- A civic action including medical assistance was held in the AWA community in the province of Carchi with Army personnel, providing services to 1,092 people.
- Preparation and execution of the Armed Forces Contingency Plan to deal with a potential Influenza A pandemic in Ecuador, in support of the Risk Management Technical Secretariat.

**Source:** *Informe de Gestión del Ministerio de Defensa Nacional*, 2009, information provided by the UEMPE and websites of the Ministry of National Defence and the Office of the Vice President.



Analysis:

## Ecuador: Political Redefinitions, Institutional Adjustments and Regional Projection

**Pablo Celi**

*Central University of Ecuador*

The performance of the defence sector has evolved at a pace with the border conflict with Colombia; the institutional reforms regarding the Ministry of Defence and armed forces; and the regional projection of the South American Defence Council, chaired by Ecuador over the last year.

### Conflict and Defence

Continuing with the trend arising from the application of *Plan Colombia*, the ripple effect of the Colombian internal conflict on the country's northern border continued to be the main cause of tension in the security and defence sector. This was soured by the political and military effects of the raid by the Colombian military on a Revolutionary Armed Forces of Colombia (FARC) camp in Ecuadoran territory in March 2008. As a result, bilateral relations were severely damaged and an atmosphere of instability and confrontation has prevailed ever since, affecting the evolution of the defence system and triggering the deployment of troops to the border, causing the upgrading of infrastructure and armament, and a functional and operational reorganization process for the armed forces.

Border control continues to be a cause of recurring tension between Ecuador and Colombia, which share a 720 km frontier populated by guerrilla, paramilitary and drug dealing groups. Still dependent on internal politics, bilateral relations are making slow progress following the reinstatement of the Binational Border

Commission (COMBIFRON) in November 2009, as an immediate-response body charged with coordinating, assessing and monitoring military and law-enforcement efforts regarding border security.

Beyond the military arena, tension with Colombia has had an impact on many aspects of Ecuador's foreign policy transcending the sub-regional context and reaching the agendas of entities such as UNASUR, ALBA (the Bolivarian Alliance for the Peoples of the Americas) and the OAS, as bilateral conflicts are intertwined with multilateral concerns regarding the US presence in the area and the rise in defence spending and the purchase of armament by the countries involved in the conflict.

### Institutional Reform

The security and defence system reform is a significant aspect to be considered when restructuring the country's public institutions and stems from the changes set out in the new Constitution enacted in 2008. The supreme law establishes a set of principles outlining the scope of action of law enforcement and national defence bodies by eliminating the concept of "*public force*" that previously grouped the Armed Forces and the National Police, which are now entrusted functions clearly differentiated in the Constitution, and aimed at enhancing their missions and achieving professionalization.

Institutional reforms involve a process that combines constitutional definitions, legal reforms and adminis-

trative decisions for the systemic structuring and management of security and national defence.

Civilian bodies are in charge of ministry restructuring in accordance with the guidelines established in the 2010-2013 National Defence Ministry's Strategic Plan, developed on the critical premises of achieving administrative and operational integration among the three armed forces through the integration of the command, administration, joint operations and training functions; consolidation of intelligence systems; validation and compatibility of equipment; and joint acquisitions in order to reach economies of scale.

Especially significant is the policy aimed at strengthening the armed forces' operating capacity, as reflected by military equipment acquisitions and the upgrade of ammunitions and military infrastructure. The acquisition system is now under the scope of the Ministry of Defence after the dissolution of the National Defence Board, which was replaced by the Strategic Asset Procurement Bureau.

In an effort to achieve cost-effectiveness in the defence sector, the ministry's plan involves maintaining defence-related or strategic companies and fostering investment or strategic alliances aimed at supplementing technology or achieving independence in this area. Regarding education, technology and applied research, the purpose is to have a comprehensive and integrated technology research and development system for the defence sector.

The Constitution establishes that the armed forces may participate in economic activities only when they are related to national defence. However, the required disinvestment processes have been moving slowly and nearly 30 companies in the agricultural, industrial, commerce, transportation, hospitality, textile and aeronautical sectors are still being managed with some degree of military involvement.

One of the highlights has been the civil intervention and control of selected bodies traditionally managed by direct or indirect military leadership, such as national security entities and intelligence services.

The Public and State Security Act (*Ley de Seguridad Pública y del Estado*) established the creation of the Public and State Security System, under which the former National Security Committee (COSENA) was replaced by the Public and State Security Council (*Consejo de Seguridad Pública y del Estado*), defined as an advisory body for the President of the Republic in matters involving public security plans, policies and strategies. Also defined by the same act as executive defence bodies are the Ministry of Defence and the Ministry of

Foreign Affairs (which will coordinate cooperation, information exchange and joint military operations), and the armed forces.

Similarly, the National Intelligence Secretariat has been also set up under civilian conduct, with the mandate to coordinate and integrate the activities of military and law-enforcement bodies in the national intelligence system (so far having autonomous operations), as well as those related to the Security of the President of the Republic. Furthermore, the Secretariat was also entrusted with drafting the Integrated National Security Plan.

### Integration and Defence

Setting as one of the priorities for Latin America and the Caribbean integration the aim of "driving a common defence policy that consolidates a strategic alliance aimed at strengthening national and regional sovereignties", the new Constitution has prompted the Ecuadoran government to emphasize the importance of security and defence integration mechanisms, both at UNASUR and the South American Defence Council levels and also regarding its participation in the ALBA.

Despite the complex environment at the time Ecuador took over the Chairmanship of the South American Defence Council due to the regional resonance of the Colombia-Ecuador conflict, the tensions caused by the US presence in military bases in Colombian territory, military acquisitions and security and defence agreements with non-regional countries, the entity has managed to gain regional significance as a confidence-building venue for multilateral cooperation.

Consolidation of the institutional weight of the South American Defence Council has been supported by the execution of its Action Plan, mainly addressing the creation of a mechanism for consultation, information and assessment of risk situations; the exchange of information and transparency in military budgets and acquisitions; management of joint relief efforts; definition of political and doctrine approaches; promotion of training programs; and, most significantly, the development and approval of mutual confidence measures.

Ecuador's agenda views security and defence integration mechanisms and processes as a component of political integration, in order to develop alternative cooperation environments to the declining Inter-American system; all this amid the inexistence of a regional security system, and as a component of political guidelines for the armed forces management.



# El Salvador

## The Legal Framework and the Defence System

### National Legislation

#### Systems and Concepts

- Organic Law of the Armed Force of El Salvador (DL N° 353 - 1998/07/30)
- Act on the Intelligence Agency of the State (DL N° 554 - 2001/09/21)
- National Defence Act (DL N° 948 - 2002/10/03)

#### Military Organization

- Military Justice Code (DL N° 562 - 1964/05/29. Last amendment: DL N° 368 - 1992/11/27)
- Act of Military Decorations (DL N° 520 - 1969/10/24)
- Act of the Armed Forces Social Security Institute (DL N° 500 - 1980/11/28. Last amendment: DL N° 1,027 - 2002/11/20)
- Act on Military Career (DL N° 476 - 1995/10/18. Last amendment: DL N° 882 - 2005/11/30)
- Act on Fire Arms, Ammunitions, Explosives and similar Articles Control and Regulation (DL N° 665 - 1999/07/26. Last amendment: DL N° 118 - 2009/10/09)
- Act on Military Service and Reserves of the Armed Force (DL N° 298 - 2002/07/30. Last amendment: DL N° 793 - 2009/01/14)

Source: Compilation based on the legislation above mentioned. For constitutional provisions see Chapter 1.

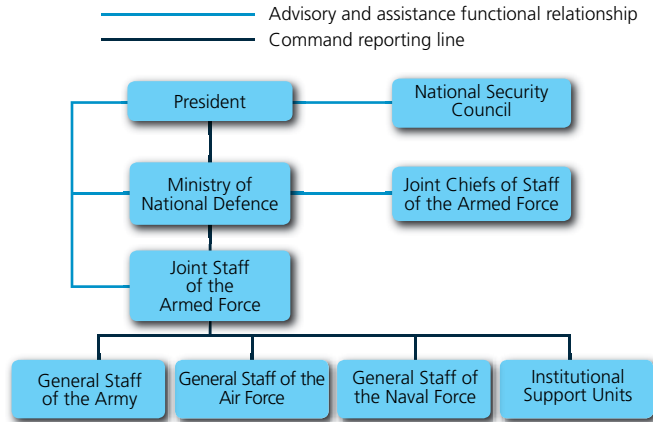

The President is advised by the National Security Council, composed of the Vice President, the Ministers of Foreign Affairs, Government, Economy and Defence, the General Director of the National Civil Police, the Executive Director of the State Intelligence Agency and the Chairman of the Joint Chiefs of Staff of the Armed Forces. The Minister of Defence is the communication line for all the orders issued by the President to the Armed Forces, through the Joint Staff, responsible for the conduction of the branches and the support units, and advisory body for everything related to the employment and administration of the institution. The Joint Chiefs of Staff advice the Minister on aspects related to military policy and the employment of the military power in national defence. The Legislative Assembly holds the powers granted by the Constitution and permanently monitors defence related issues through the Defence Committee.

Source: Compilation based on the Political Constitution, *Ley orgánica de la Fuerza Armada de El Salvador* (DL N° 353 - 1998/07/30) and *Ley de la defensa nacional* (DL N° 948 - 2002/10/03).

## The Budget

Year	Defence Budget (in US\$)	Government Budget (in US\$)	GDP (in US\$)
2006	106,363,230	4,234,024,990	17,527,000,000
2007	111,400,520	4,262,214,930	20,234,000,000
2008	115,409,495	4,558,300,000	21,824,000,000
2009	132,861,405	5,038,433,545	22,166,000,000
2010	132,874,110	5,124,169,115	21,805,000,000

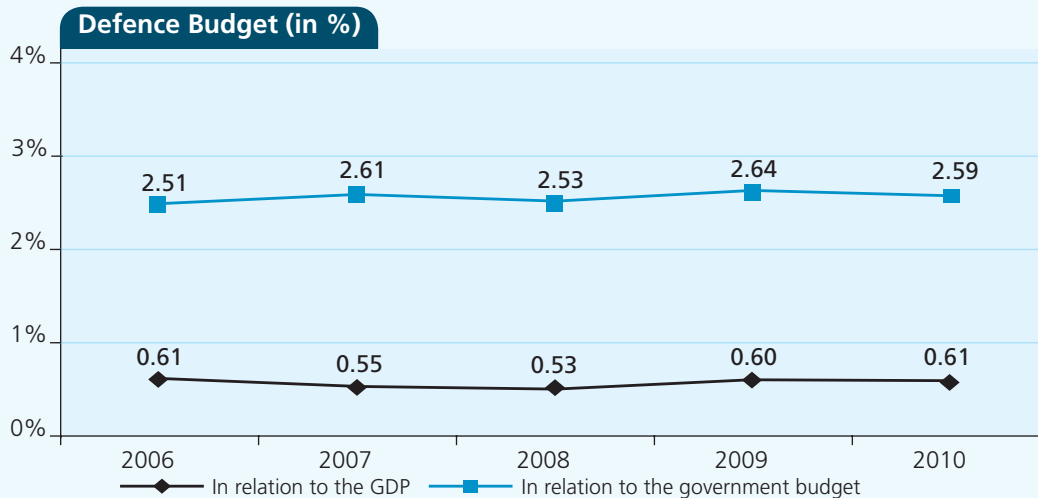

**Defence Budget Breakdown**

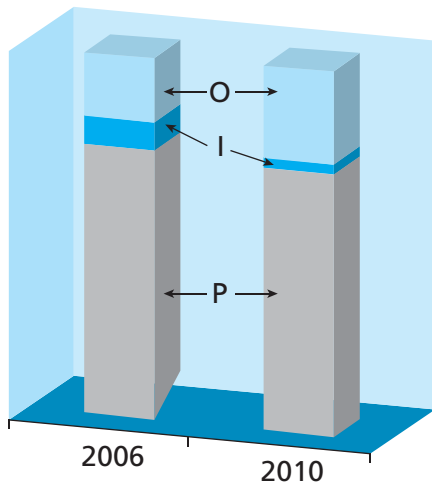

**P:** Salaries and other benefits  
**R:** Retirement and pension funds / **I:** Investment  
**O:** Other expenses

**Comparative Increase (% variation 2006-2010)**

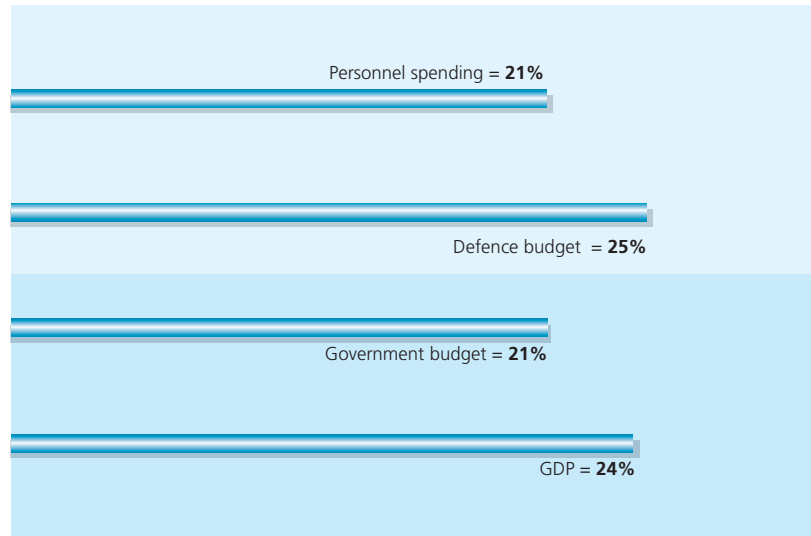

**Defence Budget 2008 (in Local Currency - US\$)**

Branches*	Salaries	Goods and Services	Other Current Expenses**	Capital Expenses	TOTAL
<b>National Defence</b>					
Institutional Direction and Administration					
Higher Administration	1,916,490	4,070,890	141,500	0	6,128,880
Institutional Financial Management	348,735	0	0	0	348,735
Institutional Operating Management	94,259,640	.....	.....	.....	94,259,640
Army Operations and Institutional Support Actions		20,586,715	607,130	0	21,193,845
Air Force Operations		2,030,430	21,985	0	2,052,415
Naval Force Operations		1,362,555	28,040	0	1,390,595
Support to other entities					
Institute of Social Services of the Armed Forces	0	0	3,500,000	0	3,500,000
Institutional Investment					
Physical Infrastructure	0	0	0	1,288,960	1,288,960
Strategic Communications	0	0	0	2,711,040	2,711,040
<b>TOTAL</b>	<b>96,524,865</b>	<b>28,050,590</b>	<b>4,298,655</b>	<b>4,000,000</b>	<b>132,874,110</b>

\* Budgetary units.

\*\* Includes taxes, rates and rights; insurances, fees and bank expenses; current transfers to the public sector; and current transfers to the external sector.

**Composition of Defence Budget 2010**

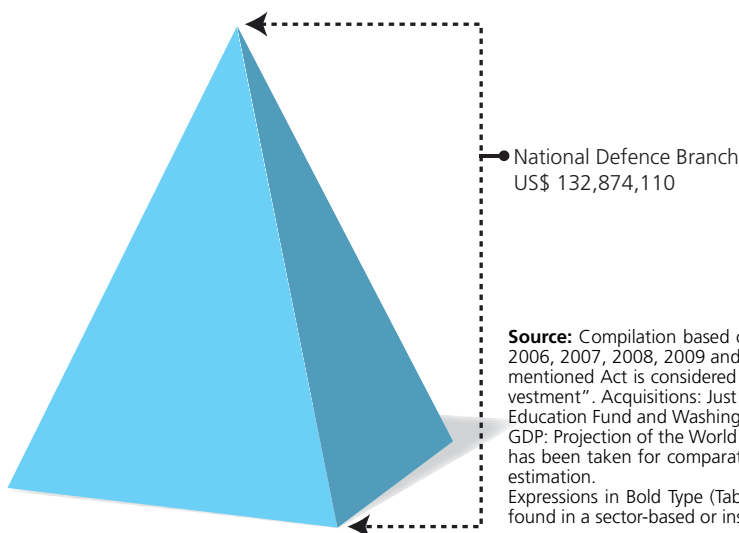

Between 2007 and 2009, the contracts for military acquisitions signed with the United States totalled US\$ 33,828,684. That amount represents 9.4% of the budget allocated to defence for those years.

**Source:** Compilation based on *Ley de presupuesto general del Estado y de presupuestos especiales* 2006, 2007, 2008, 2009 and 2010. The State Budget passed by the Congress by means of the above mentioned Act is considered herein. The concept of investment is that expressed in "Institutional investment". Acquisitions: Just the Facts (Centre for International Policy, Latin American Working Group Education Fund and Washington Office on Latin America).  
 GDP: Projection of the World Economic Outlook Database, IMF, of each year under review. This source has been taken for comparative purposes. Each country prepares the budget based on its own GDP estimation.  
 Expressions in Bold Type (Table) make reference to the various defence budget items, which can be found in a sector-based or institutional classification of the Budget Act.



**The Ministry of National Defence**

**Responsibility:**

It is the main advisory body of the President of the Republic and General Commander of the Armed Forces in relation to national defence. It directs the military field of action.

(Ley de la defensa nacional, DL N° 948 – 2002/10/03, Sec. 19)

**Organization Chart and Personal**

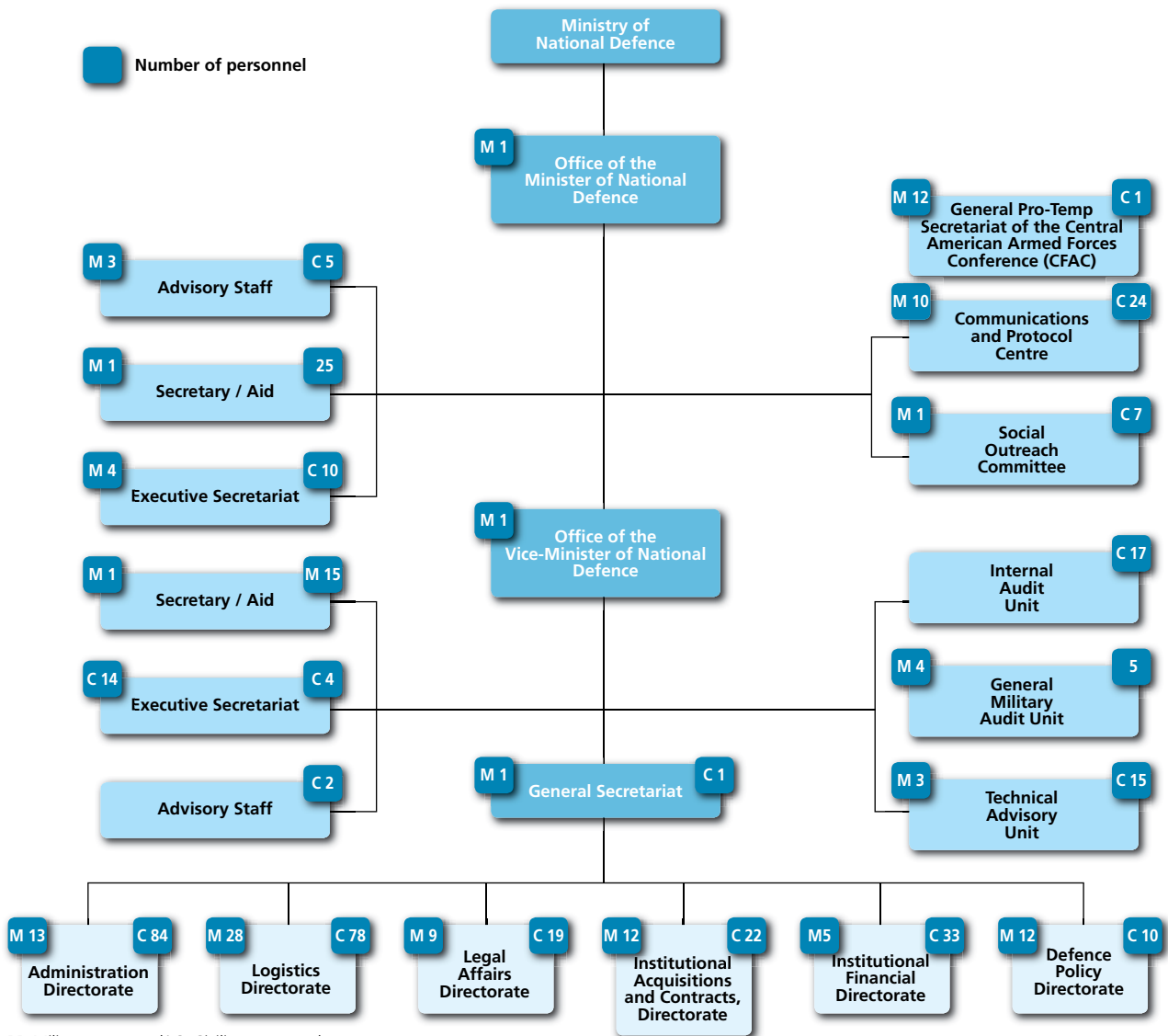

M: Military personnel/ C: Civilian personnel

**Note:** The total number of personnel is 492 employees (57 staff officers, 13 junior-grade officers, 53 NCO's and 369 administrative personnel).

<b>Date of Foundation:</b> 1939
<b>Current Minister (September 2010):</b> David Mungía Payés
<b>Can military members be Ministers of Defence?:</b> Yes
<b>Number of military members who were Ministers of Defence:</b> 26
<b>Number of civilians who were Ministers of Defence:</b> None
<b>Have there been any women in charge of the Ministry of Defence?:</b> No
<b>Average stay in the Minister of Defence position:</b> 2 years and 8 months

[The Minister currently in charge is not considered. The creation date is related to the moment in which the term "Defence" becomes part of the Institution's name]

**Source:** Compilation based on information provided by the Ministry of National Defence.

## Political Definitions

### Policy Guidelines

El Salvador is internationally recognized for its efforts to promote the respect of human rights, peace, democracy, economic development, regional integration, advancement, dialogue and good relations with all the nations of the world.

### Institutional Vision

Prepare an Armed Force capable of accomplishing its constitutional mission under any circumstances, which may be an effective instrument for the furtherance of regional integration, peacekeeping and international security.

The 2010 Arce Plan provides for the following:

- Education: promote national defence education and culture among the Salvadorian society, and consolidate the Armed Force's educational system.
- Doctrine: systematize the institutional doctrine through the harmonization of the Armed Force's organization, education, and training and planning systems; optimize the capacity of the structures in charge of the modernization of the military doctrine.
- Institutional projection: advance a national defence culture among the Salvadorian society, promoting civil-military relations and support to different governmental programmes by participating in and contributing to national development.
- Humanitarian assistance in case of disaster: strengthen institutional capabilities to provide timely and effective support in case of a national disaster. Develop a systematization and standardization process for all procedures, in coordination with other government agencies within the framework of the civil protection system.
- Legislation: propose, update, and harmonize legal regulations governing the national defence system.
- Financing: establish the necessary budgetary structure to strengthen institutional capabilities and set up procedures to increase sound and efficient investments.
- Organization: design and implement an organization capable of taking the institution to the next level of versatility, so as to meet State demands within the constitutional framework.
- Armed Force branches: develop their operational readiness in order to effectively perform the constitutional mission and respond to the missions arising from the compliance with governmental programmes.
- Logistics system: optimize the Armed Force's logistics system in terms of sustainability and support to military units in the fulfilment of their mission.

### Priorities:

- Improve the Armed Force's operational-readiness level, maintaining a reasonable number of highly trained and equipped troops, under the command and control of a strong leadership.
- Continue strengthening the educational and training system of the Armed Forces's members.
- Enforce activities associated with records, document issues, control and regulation of arms, ammunitions, explosives and similar items.
- Strengthen and update the Armed Force branches, so as to effectively safeguard the international political limits, territorial waters and national air space.
- Strengthen instruction and training of military reserve members, as a means to improve mobilization capacity in case of emergency.
- Continue to support public security for the maintenance of internal peace.
- Further contribute to the promotion of world peace.
- Strengthen institutional representation abroad.
- Improve military unit's facilities and logistics services, and advance medical care services for the members of the Armed Force and their families.

**Source:** *Plan Quinquenal de Desarrollo 2010-2014*, *Informe de Labores* (junio 2008 – mayo 2009), Ministry of National Defence and *Informe de Labores* (junio 2009 – mayo 2010), Ministry of National Defence.

El Salvador published the *Libro de la Defensa Nacional* (Book of National Defence) in 2006.

### Reports Submitted to the United Nations and the OAS

1997	1998	1999	2000	2001	2002	2003	2004	2005	2006	2007	2008	2009
						✘			✘	✘		
			◆	◆	◆		◆			◆		
	✱	✱		✱	✱		✱		✱			✱

Register of Conventional Arms: ✘ Register of Military Expenditures: ◆ Implementation of Confidence and Security Building Measures: ✱

**Source:** Compilation based on reports submitted to the United Nations Register of Conventional Arms and the United Nations Instrument for Reporting Military Expenditures and reports submitted to the OAS on the Implementation of Confidence and Security-Building Measures.



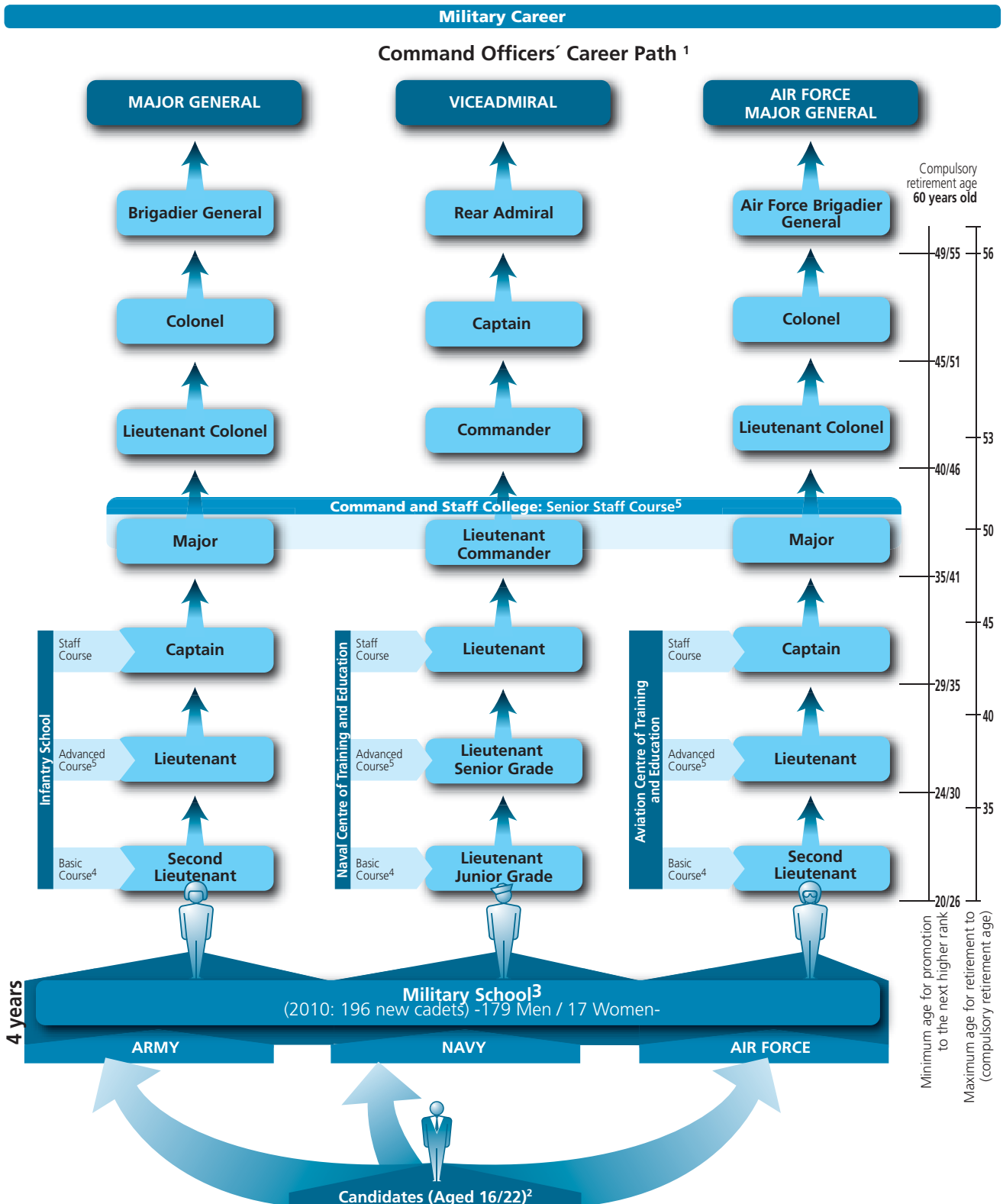

1 Command corps includes officers who have been educated at military academies from the beginning of their professional careers. The graph makes a theoretical reconstruction of officers' promotion through the completion of mandatory courses. Further requirements for promotion have not been considered.

2 The ages of 16-22 have been considered for comparative purposes. The minimum age for promotion shall depend on the age of graduation from the military institution.

3 Air Force and Naval Force cadets attending the Military School shall do their third and fourth years at the Military Aviation School and Military Naval School respectively.

4 Basic and advanced courses are taken at the corresponding service's school.

5 According to the Military Career Law Regulation, the first year of the Senior Staff course must be to get promoted to Lieutenant Colonel.

**Source:** Compilation based on *Ley de carrera militar* (DL N° 476 – 1995/10/18. Last amendment: DL N° 882 – 2005/11/30; *Reglamento de la Ley de carrera militar* (DE N° 50 1996/05/23. *Reglamento del sistema educativo de la Fuerza Armada* (DE N° 13 – 1998/01/26. Last amendment: D.E. N° 17 –2004/02/ 27). New cadets: Information provided by the Ministry of National Defence.

### The Armed Forces

#### General Mission

The mission of the Armed Forces is to defend the sovereignty of the State and integrity of the territory. The President shall exceptionally make use of the Armed Force to keep internal peace, in accordance with the Constitution. The Armed Forces shall cooperate in actions for public benefit as assigned by the Executive and shall assist the people in case of national disasters. (Constitution of the Republic, Sec. 212)

#### Specific Missions

##### Army

Its mission is to defend the country's sovereignty and the land territory in coordination and support of the other Armed Force branches; render aid to the population in case of national disaster; cooperate with acts of public benefit and, exceptionally, contribute to the maintenance of internal peace.

##### Navy

Its mission is to defend the sovereignty and territorial integrity of the State in its territorial waters and --in a combined manner-- the Gulf of Fonseca and insular territory in coordination with the other Armed Force branches; protect marine riches, the subsoil and national seabed; render assistance to the population in the event of national disaster; cooperate in acts of public benefit and, exceptionally, contribute to the maintenance of internal peace, as well as execute maritime jurisdiction tasks to enforce navigation laws and assist the respective authorities for compliance with tax and immigration laws.

##### Air Force

Defend the sovereignty of the State and integrity of the national air space, support ground forces in the accomplishment of their respective missions; render assistance to the population in cases of national disaster, cooperate in public benefit work and, exceptionally, contribute to the maintenance of internal peace.

#### Total Strength: 14,262

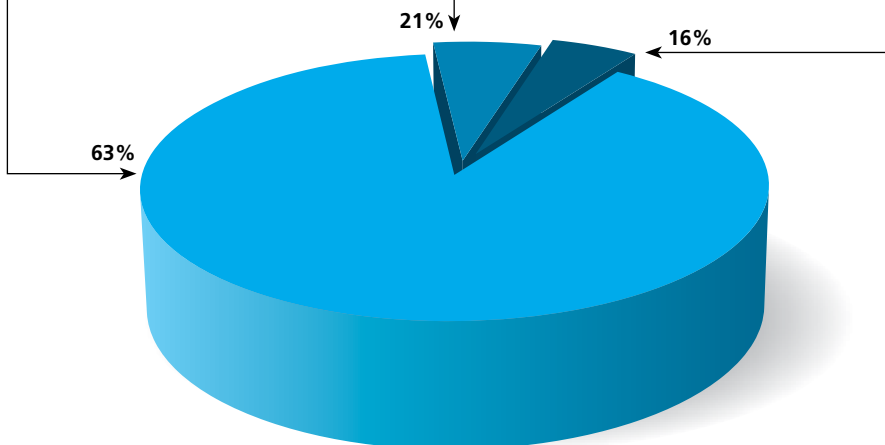
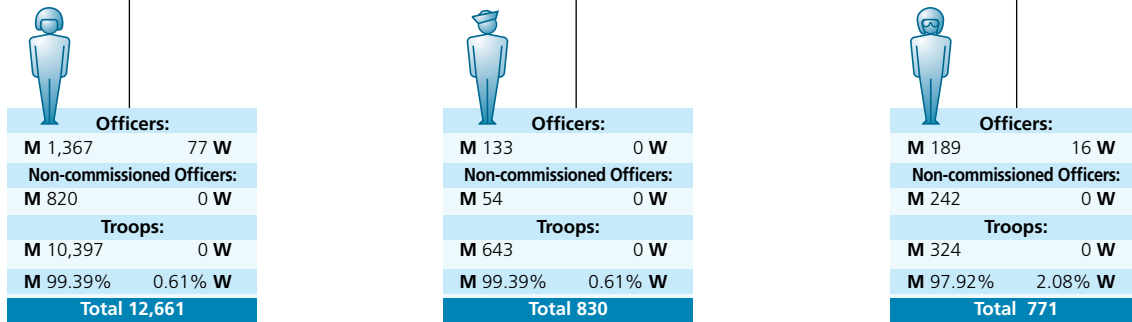

M: Men / W: Women

Source: Libro de la Defensa Nacional, 2006 (missions) and information provided by the Ministry of National Defence (Regular Force).



**Women in the Armed Forces**

**Women's Admission to the Armed Forces (year)**

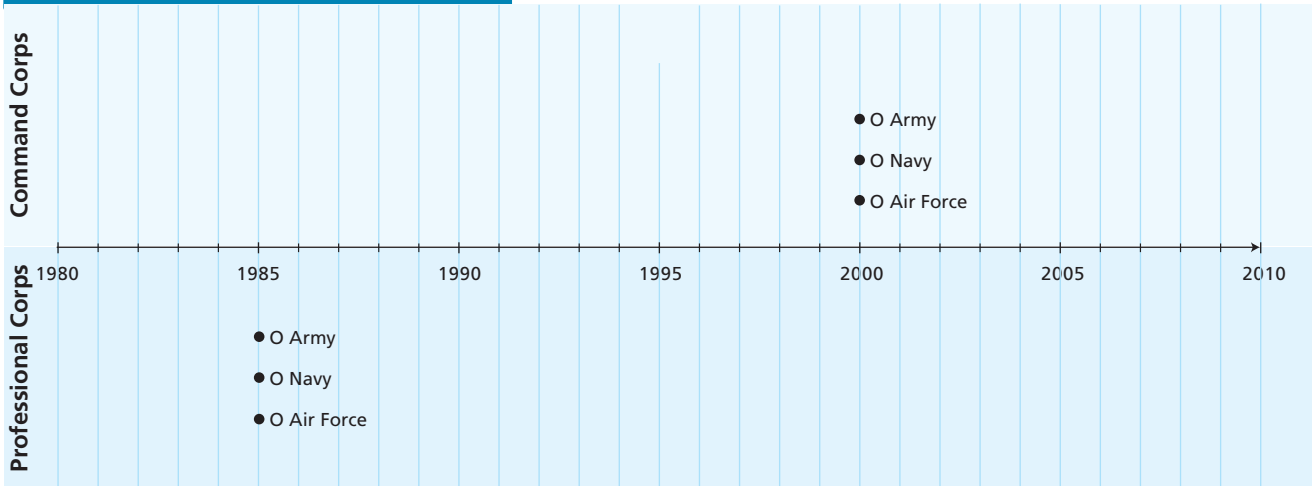

O: Officers

**Note:** Women are not admitted as non-commissioned officers in the command corps or the professional corps of any of the three services. The Command corps includes officers who have been educated at military academies from the beginning of their professional careers. The Professional corps refers to those who develop a career in the civilian sphere and are then incorporated to the armed forces.

**Women Officer who have reached the highest rank in the Command Corps (2010)**

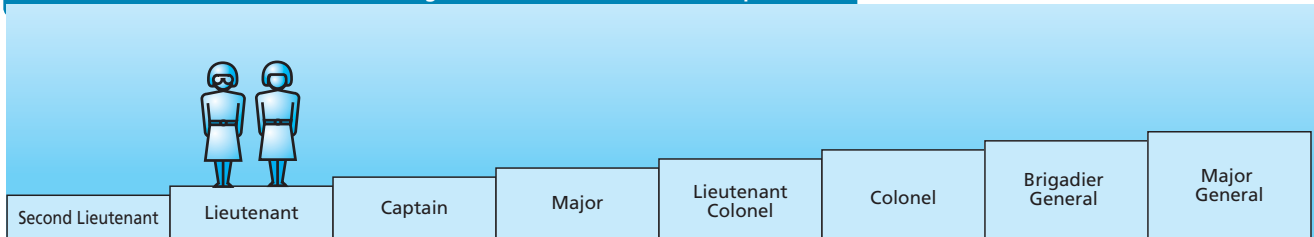

**Note:** These ranks correspond to the Army, as an example. The equivalent rank for Lieutenant is Lieutenant (Air Force). In the Naval Force, women are currently in their 3rd year of training.

0.65 % (93) of the total Armed Forces are women.

**Source:** Information provided by the Ministry of National Defence and the Peacekeeping Training School of El Salvador Armed Forces (Escuela de Operaciones de Paz de la Fuerza Armada - EOPFA).

**Military Service**

It is mandatory for all male population and it is conducted in the whole national territory for a period of one year. At present, it is voluntary for women. The number of people enrolled is determined by existing vacancies.

	Number of applicants and enlisted to the military service					
	2009			2010		
	Army	Navy	Air Force	Army	Navy	Air Force
Applicants	1,613	92	74	1,409	-	127
Enlisted	224	67	-	995	-	63

Men exempted from Military Service shall include those who have received military training during a period of 24 months, have attended Military Officer Training Centres for at least one year, the Armed Force administration personnel on duty for no less than twenty-four months and those who are rendering professional or technical services to the Armed Force.

**Source:** Information provided by the Ministry of National Defence and *Ley de Servicio Militar y Reserva de la Fuerza Armada* (DL N° 298 – 2002/07/30. Last amendment: DL N° 793 – 2009/01/14).

## Defence and National and International Community

### Participation in Peace Operations

Current missions	Military Component			
	EMM		MC	
	Men	Women	Men	Women
MINURSO (Western Sahara)	5	-	-	-
UNIFIL (Lebanon)	-	-	52	-
UNMIL (Liberia)	2	-	-	-
UNMIS (Sudan)	4	-	-	-
UNOCI (Ivory Coast)	3	-	-	-

The Peacekeeping Training School, EOPFA, was created on July 1st, 2004.

Since the beginning of 2010, 138 military troops were instructed and trained in peace operations.



MEM: Military experts on mission, including military observers, judge advocates and military liaison officers, among others - MC: Military Contingent.

**Source:** Compilation based on documents from the Department of Peacekeeping Operations of the United Nations. Data as of 31 August 2010.

From August 2003 to December 2008, El Salvador took part in reconstruction and humanitarian assistance tasks in Iraq, with the "Cuscatlán Battalion", within the framework of the MNF - I mission (Multinational Force - Iraq)

At an early stage, said battalion was part of the "Plus Ultra" Multinational Brigade together with Nicaraguan, Honduran and Dominican troops, and coordinated by Spanish forces. In May 2004, the Spanish Government decided to pull out. El Salvador continued in the mission until December 31st, 2008.

Overall, it has contributed with 11 contingents -3,781 troops- and cooperated in the organization and training of the new Iraqi army and police force, as well in training Iraqi officers on Staff duties. Likewise, 353 projects for civil population assistance were carried out.

### Support Actions

#### Public security programmes

##### Joint Groups of Community Support (GCAC)\*

Deployment of 300 groups, jointly with the PNC, in rural areas and municipalities with higher crime rates.

- 58,424 patrolling operations
- 96 seized arms
- 866 arrests
- 108 detentions
- 72 drug seizures
- 11,685 vehicles inspected
- 8 vehicles recovered
- 60,600 people inspected

\* Replacement of the previous Guardian Plan.

##### "Nuevo Amanecer" Military Campaign

Permanent deployment of 2,800 troops, under 8 Task Forces and ZEUS Command, in the municipalities with higher crime rates.

- 50,127 patrolling operations
- 77 arms seized
- 1,025 arrests
- 201 detentions
- 62 drug seizures
- 122,191 vehicles inspected
- 4,819 vehicles inspected
- 328,328 persons inspected
- 153 joint operations
- 65 talks at school centres
- 31 civil population support actions
- 1,033 citizen crime reports recorded
- 14 security operations in school centres and 5 detention centres
- 102 coordination meetings with the PNC

##### Support Plan for the Directorate of Detention Centres

Reinforce the external perimeter security of penitentiaries and other detention centres.

- 467 patrolling operations
- 43 arrests
- 8 detentions
- 22 drug seizures
- 500 vehicles inspected
- 3,000 people inspected
- 110 cell phones seized

#### Cuscatlán Plan

Support in the fight against drug trafficking using the Cuscatlán Joint Group; with the involvement of the Navy, the Army and the Air Force, and a number of 311 troops deployed.

### Community Support Activities

#### Infrastructure

- Construction of temporary housing in the municipality, San Salvador and San Vicente.
- Risk mitigation work at San Salvador creeks.
- Support for the repair and reconstruction plan in San Vicente and La Paz departments.

#### Health

- 8 civil-military combined actions on health care, biomedical equipment repair and medicine delivery; 5,858 beneficiaries.
- 3 national health campaigns for medical and ophthalmologic check-ups; delivery of medicines and glasses; benefiting 16,539 inhabitants.
- Support to different governmental plans to fight the "dengue" disease, taking part in inspection, treatment and elimination of the mosquito-breeding places and housing fumigation; benefiting 33,615 persons.
- The Armed Force supports the MSPAS in the prevention, control and epidemiologic surveillance tasks in case of an AH1 N1 influenza pandemic.

- 13 civil-military combined actions in coordination with the US Army, including medical and veterinarian campaigns and delivery of medicines. 81,218 inhabitants were benefited.

#### Education

High-school and university scholarships for 114 underprivileged youngsters to continue their education in the areas of commerce, nursery, and health technician.

#### Environment

- "Castor Plan", waste collection, cleaning of creeks, waste lands and green areas.
- Reforestation programmes in coastal areas and marine environmental preservation.
- Support for control and prevention of forest fires.
- Winter Plan, to aid those affected by hurricanes and storms.

**Source:** *Informe de Labores (junio 2008 – mayo 2009)*, Ministry of National Defence and *Informe de Labores (junio 2009 – mayo 2010)*, Ministry of National Defence.



## Analysis:

# El Salvador: Defence and Public Security Policy

**Antonio Martinez Uribe**

*Professor, Universidad de El Salvador*

When President Mauricio Funes became the Head of the State as a result of a proposal of the Farabundo Marti National Liberation Front (FMLN), the first priority was thought to be the reinstatement of the Peace Agreements (AdP, Spanish acronym).

At a certain point of time the Agreements led to reforms to the Constitution; the agreements were first negotiated and the Constitution was reformed almost at the same time. As a matter of fact, a new Constitution was politically issued without a new Constitutional Assembly to refound the Salvadoran State. And this was the case because the large reform introduced (which was *raison d'être* of the AdPs and the great concession to FMLN guerrilla) was clear: reformulating the use of force, which is at the heart of any State, in the framework of the need to democratize the Salvadoran political regime. A fundamental issue was the reform of its armed institutions; particularly depriving the military of the dominating role they had historically played in public security, which had led them to grave human

right violations. In exchange for that, the FMLN accepted the dissolution of its own military force. Hence, its transcendence.

The military were in control of the various public force militias, a significant part of them made up of civilian members (especially in rural areas). And, of course, they controlled the whole military apparatus. Following the pact with the guerrilla for the cease fire and the end of armed conflict, all those functions were distributed among different agencies: the Supreme Court of Justice, the new Supreme Electoral Court, a new National Civil Police (PNC) and the Attorney's Office for Human Rights Defence were created, among other innovation plans of considerable magnitude. All this meant, aside from difficult amendments to the concepts of military doctrine and public security, a depuration and downsizing of the military force. Clearly, the military would then be in charge of national defence, understood under the terms of the pact, as the defence of the nation vis-a-vis an external threat.

The governments of the ARENA (Nationalist Republican Action) had committed the Armed Force to public security since 1993, one year after the signing of the AdP, during President Alfredo Cristiani's term in office. Nowadays, twenty years after that political event, it seems common that the military should be involved in something which, under Constitutional mandate, is exceptional and a matter that belongs with civilian institutions' responsibility.

The reforms were introduced in order to install a democratization system and political system in El Salvador, overcoming the severe problems of the past and to start to build and consolidate the rule of law. However, in El Salvador, the State has been dysfunctional to control violence, crime in all forms and guaranteeing citizen security, which is a fundamental priority among its functions. In this context, the issue arose of fully involving the military to bring order to a particularly extreme situation. If the AdP and the Constitution establish that the armed forces may be called upon only in emergency situations, i.e. states of exception, have we been living an emergency situation since 1993, just one year after the signing of the AdP?

Since 1992 El Salvador has clearly distributed the roles between police and military, maybe as no other Latin American nation. Military officers from the region have since then, appreciated the conceptual advance agreed for the FAES as a result of the end of internal military confrontation.

In a setting of severe economic challenges, El Salvador also has to resolve the acute problem of violence in its many forms of expression: crime, organized crime, gangs, drug-trafficking. The new government of President Funes has had to face this difficulty already at high levels in El Salvador, but present to a larger or lesser extent in all Central America.

Preceding administrations were unable to find a solution to this problem, justifying military presence in public and citizen security. The actions taken to counter it were particularly based on increasing legal punishment and hence State crackdown of violence. Since then, the military have been involved in public security accompanying the National Civil Police, a corps created as part of the implementation of the Peace Agreements. But the situation has been worsening. The new government, without a clear and unanimous support of the FMLN, has continued along the same courses of action.

Last November, when violence reached unbearable levels, President Mauricio Funes ordered the deployment of 2,500 soldiers to support police action in its

fight against crime, especially through deterring patrolling and control of areas where violence was rampant. Those troops were added to 1,600 other soldiers who were already acting since the previous administration.

At present, the El Salvador Army is virtually "at war": last June 1,500 troops started to occupy penitentiary centers, while 1,000 additional men initiated their deployment in 75 of all 300 "blind points" in Salvadoran borders. This is a "porous" frontier that allows the passage of smuggled goods, drug and weapon trafficking, illegal immigration and human trafficking. This is estimated to represent 44% of the Salvadoran troops.

These already-anticipated governmental actions began in advance in face of the new circumstances the country suffered after a bus was set on fire on Sunday, June 20, in a district of San Salvador metropolitan area, with passengers on board and a tally of 16 people killed. Naturally, the event scandalized public opinion.

In the presidential statements broadcast through the national radio chain on the past Wednesday June 23, acts such as the burnt bus were qualified as terrorism. At the same time, the President has recognized that organized crime has pervaded the State of El Salvador and that his administration is being politically destabilized through *de facto* group actions. The intense operability of the military is part of a global plan designed by the government to attempt to stem the action of violent gangs known as 'maras,' as well as organized crime.

All this occurs in a political context that, curiously, has been mobilizing. Political parties --particularly the most conservative actors-- have suffered large internal confrontations since 2009. Former President of the Republic Elias Antonio Saca has been blamed for the party's electoral failure, called a traitor and accused of embezzlement of public funds and expelled from the ARENA by the party's highest leaders. Something quite unusual until then in the country's political dynamics. In October 2009, representatives belonging to the legislative fraction of the party announced their separation and formed a new party called Great Alliance for National Unity (GANU, Spanish acronym). The Christian Democratic Party (PDC) has also suffered its own trauma. In the fight for power what gets fractioned are political leaderships, the political groups and bodies interacting within and outside of the state apparatus. Thus, the internal rows have resulted in a much-needed revitalizing element.



# Guatemala

## The Legal Framework and the Defence System

### National Legislation

#### Systems and Concepts

- Constitutive Act of the Guatemalan Army (DL N° 72-90 - 1990/12/13)
- Executive Body Act (DL N° 114-97 - 1997/11/13)
- General Bureau of Civil Intelligence Act (DL N° 71-2005 - 2005/10/12)
- Framework Act on the National Security System (DL N° 18-2008 - 2008/04/15)

#### Military Organization

- Military Code (Decree N° 214 - 1878/09/15. Last amendment: Decree N° 41-96 - 1996/07/10)
- Military Social Security Institute Organization Act (Decree Law N° 75-1984 - 1984/07/20. Last amendment: Decree N° 21-2003 - 2003/06/11)
- Act on the Support to Civil Security Forces (Decree N° 40-2000 - 2000/06/16)
- Civil Service Act (Decree N° 20-2003 - 2003/05/12)
- Arms and Ammunitions Act (Decree N° 15-2009 - 2009/04/21)

— Advisory and assistance functional relationship  
 — Command reporting line

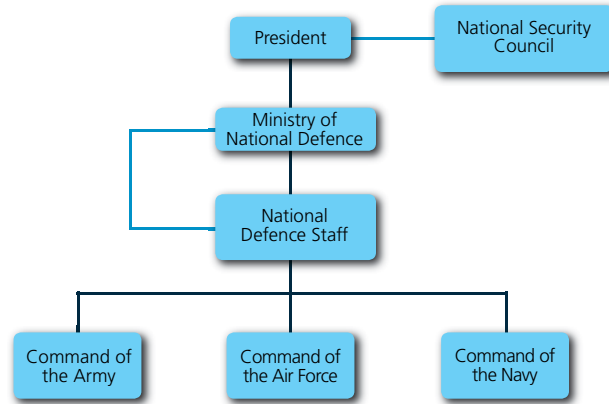

The President is advised by the National Security Council, composed of the Vice President, the Ministers of Foreign Affairs, Government and Defence, the Secretary of Strategic Intelligence of the State and the Attorney General. The President issues the orders through a General or Senior Officer who holds the position of Minister of Defence, and also has the General Staff of the National Defence as technical and consulting body, responsible for the command of the Army. The Congress holds the powers granted by the Constitution and permanently monitors defence related issues through the National Defence Committee.

**Source:** Compilation based on the legislation above mentioned. For constitutional provisions see Chapter 1.

**Source:** Compilation based on *Ley marco del sistema nacional de seguridad* (DL N° 18-2008 - 2008/04/15) and *Ley constitutiva del Ejército de Guatemala* (DL N° 72-90 - 1990/12/13).

## The Budget

Year	Defence Budget (in US\$)	Government Budget (in US\$)	GDP (in US\$)
2006	134,476,326	4,284,540,096	28,260,000,000
2007	152,106,898	4,846,266,432	33,320,000,000
2008	156,210,263	5,251,290,771	35,729,000,000
2009	153,090,192	5,849,777,368	36,471,000,000
2010	159,860,766	6,108,489,881	39,760,000,000

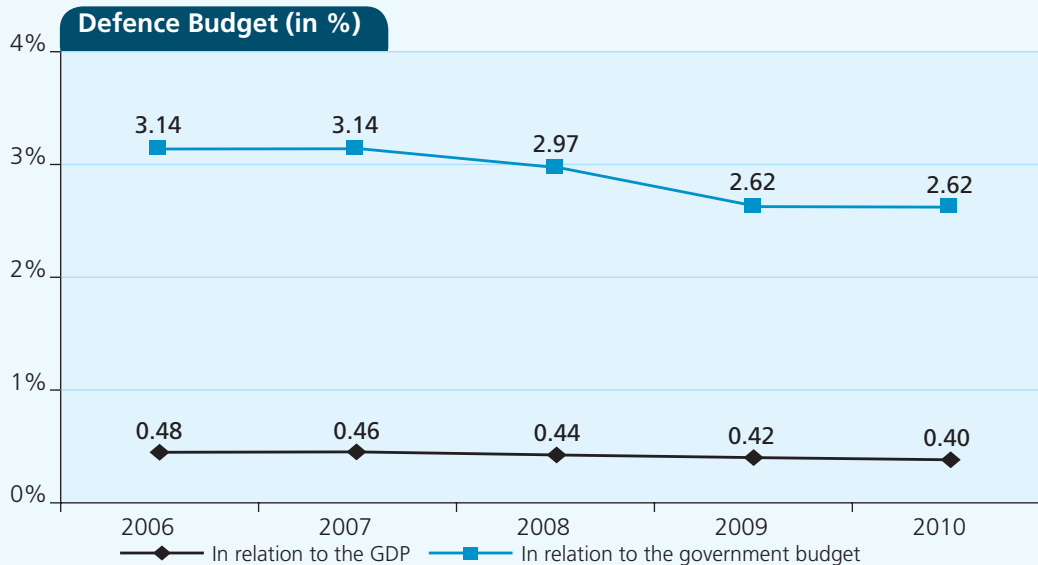

**Defence Budget Breakdown**

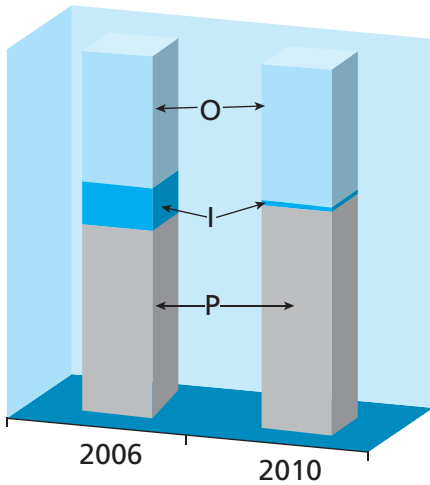

**P:** Salaries and other benefits  
**R:** Retirement and pension funds / **I:** Investment  
**O:** Other expenses

**Comparative Increase (% variation 2006-2010)**

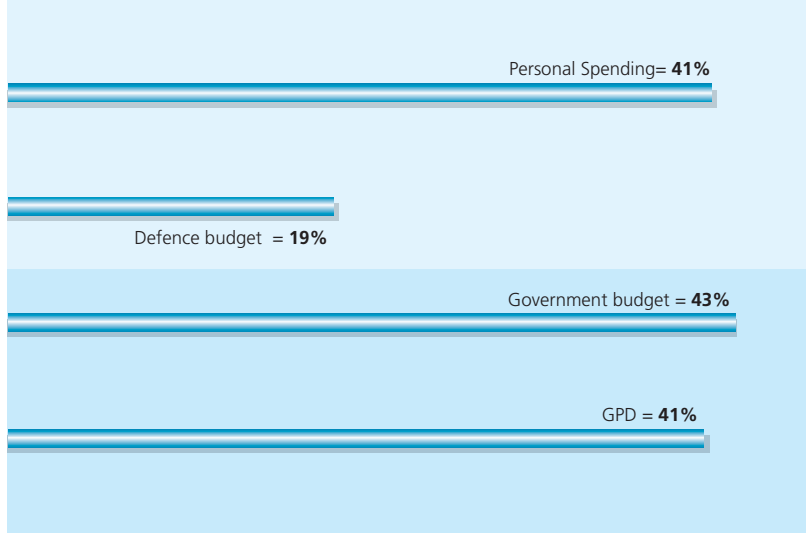

**Defence Budget 2010 (in Local Currency)**

Programs	Personnel Services	Non-personnel Services	Materials and Supplies	Others*	TOTAL
<b>Ministry of the National Defence</b>					
Central Activities	187,312,854	24,738,556	68,049,825	1,827,217	281,928,452
Independence, Sovereignty and Integrity of the Territory**	349,071,609	14,077,394	230,256,415	24,744,065	618,149,483
Military Education	158,009,369	10,085,994	33,566,872	11,338,334	213,000,569
Military Health and Social Service	46,776,680	827,697	19,346,797	175,784	67,126,958
Construction and Cartography	27,644,650	824,738	12,015,793	3,519,182	44,004,363
Military Missions Abroad	27,229,839	20,617,389	14,101,336	3,492,000	65,440,564
Regulation of National Water Spaces	6,165,782	1,049,618	2,809,436	205,017	10,229,853
Items non-assignable to programs***	0	0	0	1,386,391	1,386,391
<b>TOTAL</b>	<b>802,210,783</b>	<b>72,221,386</b>	<b>380,146,474</b>	<b>46,687,990</b>	<b>1,301,266,633</b>

\* Includes property, plant, equipment, intangible items and current transfers.

\*\* Ground defence: Q.323,048,242; air space defence: Q.69,487,639; defence of territorial waters: Q.51,613,602; citizen security corps: Q.174,000,000.

\*\*\* Funds for the Military Social Security Institute: Q.1,008,687; contribution to the International Hydrographic Organization: Q.192,424; contribution to the CFAC: Q.185,280.

**Composition of Defence Budget 2010**

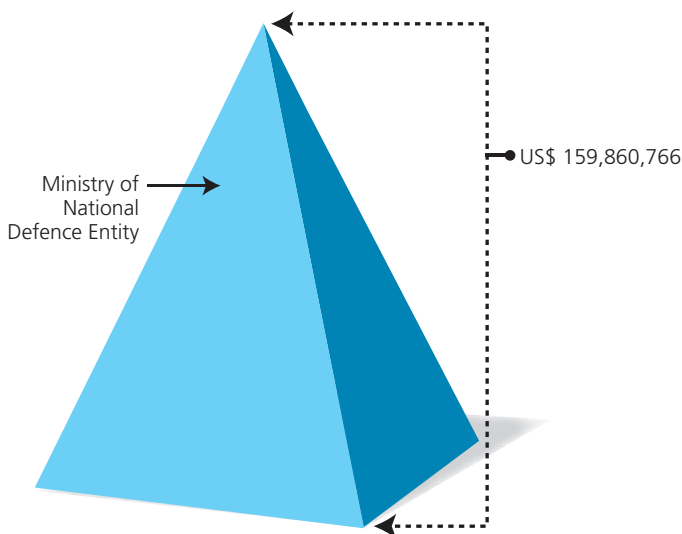

Between 2007 and 2009, contracts signed with the United States for military acquisitions reached US\$ 10,340,740. Such number accounts for 2.24% of the defence budget for such years.

**Source:** Compilation based on *Ley de presupuesto de ingresos y egresos del Estado para el ejercicio fiscal 2006, 2008 and 2009*. In 2007 and 2010, Congress did not approve the Budget Bill. Therefore, the previous year budget was in effect as provided for in the National Constitution. The difference in numbers for these years is due to changes in the dollar exchange rate. The State Budget passed by the Congress by means of the above mentioned Act is considered herein. The concept of investment is that expressed in "Properties, plants, equipment and intangible assets". Acquisitions: Just the Facts (Center for International Policy, Latin American Working Group Education Fund and Washington Office on Latin America).

GDP: Projection of the World Economic Outlook Database, IMF, of each year under review. This source has been taken for comparative purposes. Each country prepares the budget based on its own GDP estimation. The dollar value considered corresponds to the exchange rate determined by the World Economic Outlook Database, IMF, for each year under consideration. As of July, the 2010 exchange rate average is 8.08 Quetzales, based on the data provided by the Central Bank of Guatemala. For further calculations, figures are provided in local currency. Expressions in Bold Type (Table) make reference to the various defence budget items, which can be found in a sector-based or institutional classification of the Budget Act





**The Ministry of National Defence**

**Responsibility:**

The Minister of National Defence, under the orders of the General Commander in Chief of the Army (the President), shall conduct and manage the Army of Guatemala. It is the communication agency between the Army of Guatemala and the other government bodies. (*Ley constitutiva del Ejército de Guatemala, DL N° 72-90 – 1990/12/13, Sec. 15 and 17*)

**Organization Chart**

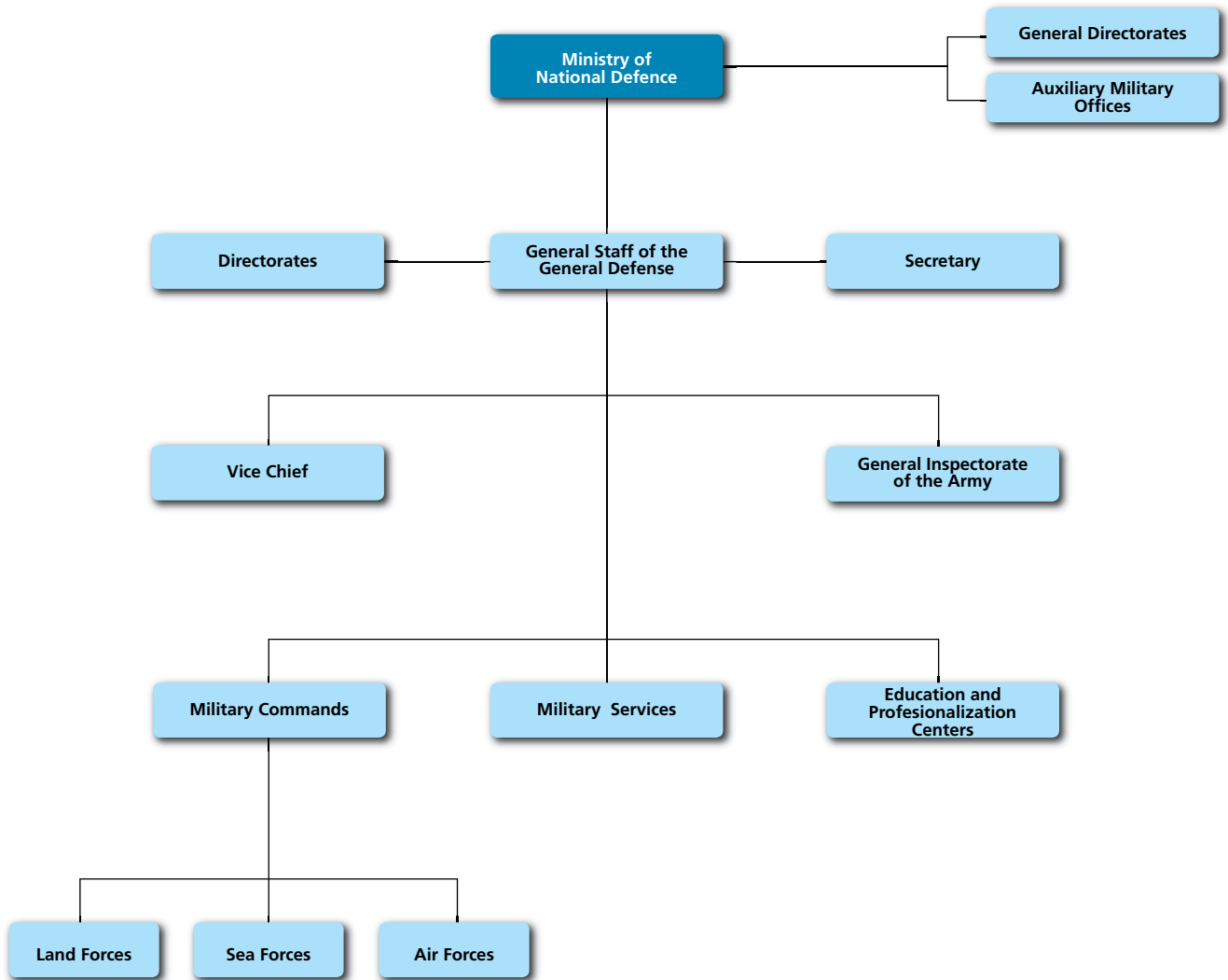

<b>Date of Foundation:</b> 1945
<b>Current Minister (September 2010):</b> Abraham Valenzuela González
<b>Can military members be Ministers of Defence?:</b> Yes. According to the Republic's National Constitution, civilians cannot become Ministers of Defence
<b>Number of military members who were Ministers of Defence:</b> 12 (since 1996, year of the Firm and Lasting Peace Agreements - <i>Acuerdos de Paz Firme y Duradera</i> -)
<b>Number of civilians who were Ministers of Defence:</b> None
<b>Have there been any women in charge of the Ministry of Defence?:</b> No
<b>Average stay in the Minister of Defence position:</b> 1 year

[The Minister currently in charge is not considered. The creation date is related to the moment in which the term "Defence" becomes part of the Institution's name]

Source: Compilation based on information provided by the Ministry of National Defence.

## Political Definitions

### Policy Guidelines

#### Vision

To have a modern Army with a defensive and deterrent power, highly mobile troops with quick deployment capabilities, in accordance with State capacity; aimed at contributing to the enforcement of the State values, principles and duties, as well as of international treaties and agreements.

#### Programmes and Activities of the Defence Sector

- Independence, sovereignty and territorial integrity: comply with the constitutional mandate of maintaining territorial independence, sovereignty and integrity, as well as the country's internal and external security, by the use of air, sea and land forces, keeping a presence at the borders.
  - Land Defence: preserve territorial integrity, with land patrolling both in the interior of the Republic and adjoining border areas.
  - Airspace Defence: conduct air operations to maintain and ensure the sovereignty of the national airspace; also, support land military troops with the purpose of neutralizing any threat against the interests of the Nation. In addition, activities are performed to help in the fight against drug trafficking, prevent destruction of wildlife, detect clandestine landing strips, and contribute to the detection of illegal substance trafficking.
  - Jurisdictional Waters Defence: ensure national sovereignty in territorial waters, in the exclusive economic zone (EEZ) and interior waters (lake and fluvial), exercising control on maritime borders, so as to jointly contribute with land and air forces to preserve territorial integrity, maintaining a permanent presence with patrolling activities.
  - Citizen Security Corps: support civil security forces in the fight against crime.
- Military Education System: military training, professionalization, technical and operational training for active members of the Army of Guatemala.
  - Military education.
  - Military training and development.
- Military Healthcare and Social Services: protect the health of active members of the Army of Guatemala, including those outside the military sphere, through healthcare centres of commands and military units in the Republic, contributing with other institutions charged with the responsibility of providing civilian medical and dental care and performing vaccination campaigns.
- Construction and Mapping: repairs, minor constructions and maintenance activities performed to the infrastructure of the different command and military facilities.
- Military Missions Overseas: participation of the Army of Guatemala in the international arena, in compliance with treaties and agreements ratified by Guatemala, to promote peaceful relations with other countries, cooperate and establish confidence-building measures (CBM's) and humanitarian assistance operations.
- Regulation of National Water Spaces: support the enforcement of the national maritime policy.

### Security Policy and Rule of Law

#### General Objective

Implement the national strategy as the reference framework to protect the life, peace, integrity, and security of the people and their property, constituting a real rule of law. For this purpose, constitutional order and compliance with Peace agreements must be strengthened with the purpose of eradicating social and economic injustice, as well as social and political discrimination. Furthermore, we shall seek to eliminate all forms of corruption, with citizen organization and involvement. All these should be based on the principle of freedom, equality, social justice and solidarity, which govern the efforts intended to counteract threats and risks to society and its institutions, ensuring the country's governance.

#### As part of specific objectives

Protect and ensure the Army's role in democratic society, pursuant to the provisions of the Political Constitution of the Republic and Peace Agreements

#### Strategies and Actions

- a. Strengthen the Army capabilities so as to enable compliance with its defence role as specified in the Constitution:
  - Continuously design plans that may respond to actual or potential threats against the interests of the Nation.
  - Organise a professional army, which may be highly versatile, defensive and efficient, as well as capable of satisfying the needs of the State.
- b. Subordinate the Armed Forces to the politically represented civilian leadership, as well as to focus their roles on external defence and humanitarian assistance.
  - Strengthen civilian control in a democratic society.
  - Create special forces to respond to emergencies caused by natural disaster.

Source: *Ley de presupuesto de ingresos y egresos del Estado para el ejercicio fiscal 2009 and Plan de Gobierno, 2008.*

Guatemala published the *Libro de la Defensa Nacional de la República de Guatemala* (National Defence Book of the Republic of Guatemala) in 2003 and the *Política de la Defensa Nacional* (National Defence Policy) in 2005.

### Reports Submitted to the United Nations and the OAS

1997	1998	1999	2000	2001	2002	2003	2004	2005	2006	2007	2008	2009
✘	✘	✘	✘	✘	✘	✘	✘	✘	✘	✘		
					◊	◊	◊	◊		◊		
					✱							

Register of Conventional Arms: ✘ Register of Military Expenditures: ◊ Implementation of Confidence and Security Building Measures: ✱

Source: Compilation based on reports submitted to the United Nations Register of Conventional Arms and the United Nations Instrument for Reporting Military Expenditures and reports submitted to the OAS on the Implementation of Confidence and Security-Building Measures.

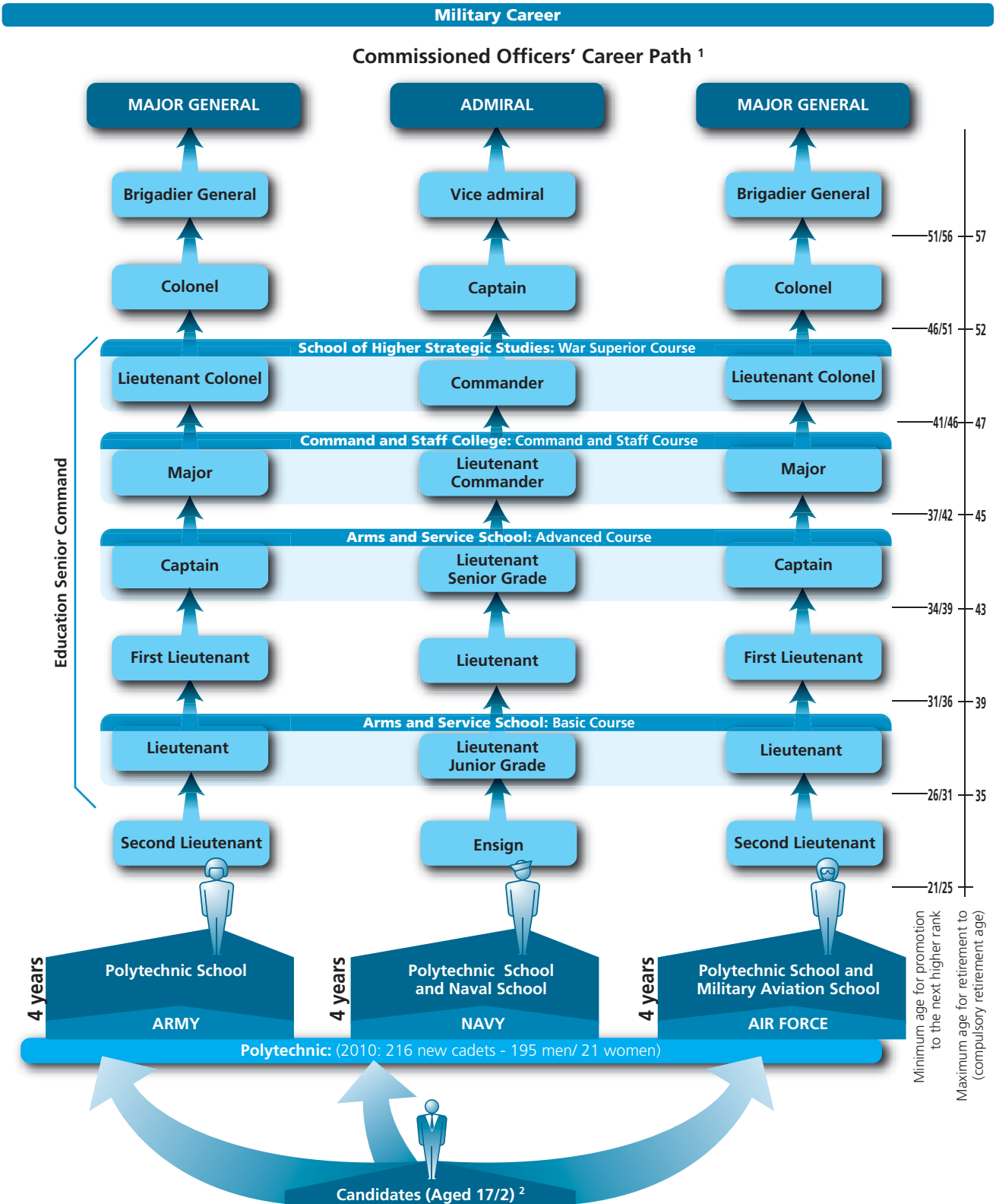

<sup>1</sup> Command corps includes officers who have been educated at military academies from the beginning of their professional careers. The graph makes a theoretical reconstruction of officers' promotion through the completion of mandatory courses. Further requirements for promotion have not been considered.

<sup>2</sup> The age of 17-21 has been considered for comparative purposes. The minimum age for promotion shall depend on the age of graduation from the military institution.

**Source:** Compilation based on *Ley constitutiva del Ejército de Guatemala* (DL N° 72-90 - 1990/12/13), Promotion rules of the Army of Guatemala (Governmental Agreement N° 318-2009 - 2009/11/26). New cadets: Information provided by the Ministry of National Defence.

**The Armed Forces**

**General Mission**

The Guatemalan Army is devoted to maintaining the independence, sovereignty and honour of Guatemala, the integrity of its territory, peace and internal and external security. The Army shall cooperate in emergency situations or public disaster. (Constitution, Sec. 244 and 249)

**Specific Missions**

**Army**

Its mission is to preserve territorial integrity, ground deterrence, the organization for the Nation's military defence, as well as the structuring of the human, territorial, economic and material resources assigned to it by the State. In times of peace, it is dedicated to education, training, strategic readiness, peacekeeping operations and the conduct of humanitarian support missions, both internally and abroad. Its mission also comprises the organization, training and equipping of the necessary forces to effectively react and conduct military operations of any nature (territorial integrity, deterrence and ground military defence) the senior leadership may order.

**Navy**

Its main mission is to guarantee the national sovereignty in the territorial sea, contiguous zone, EEZ, interior waters, lakes and rivers of the Republic, exerting control over the maritime frontiers in order to contribute, together with Ground and Air forces, to ensuring national defence.

**Air Force**

Its primary mission is to direct operations to maintain and guarantee the sovereignty of the national air space by means of air warfare, supporting military surface units, guaranteeing the freedom of action to deter, neutralize or destroy any threat against national objectives. It also cooperates with other State institutions in national efforts.

**Total Strength: 14,906**

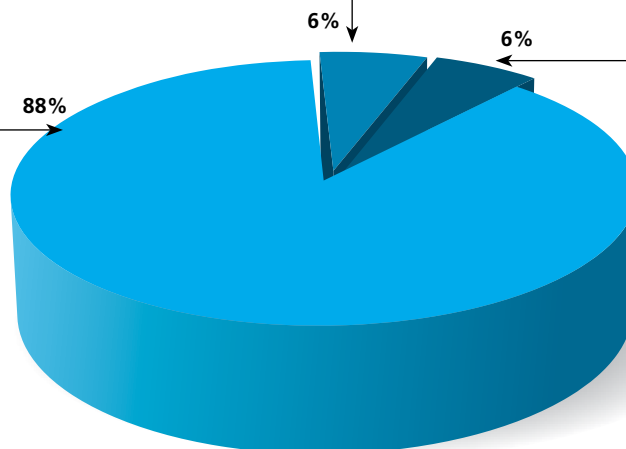
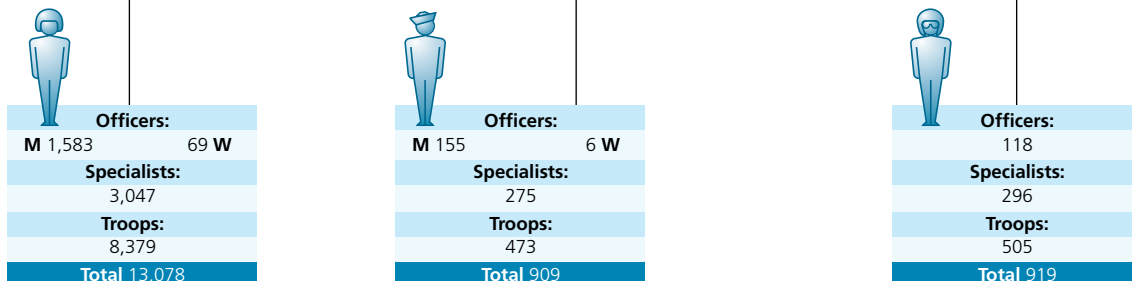

Specialists: 2,942 men and 676 women.

Troops: 8,792 men and 565 women.

**M:** Men / **W:** Women

**Source:** Websites of the Armed Forces (missions) and information provided by the Ministry of National Defence (Regular Force).



### Women in the Armed Forces

#### Women's Admission to the Armed Forces (year)

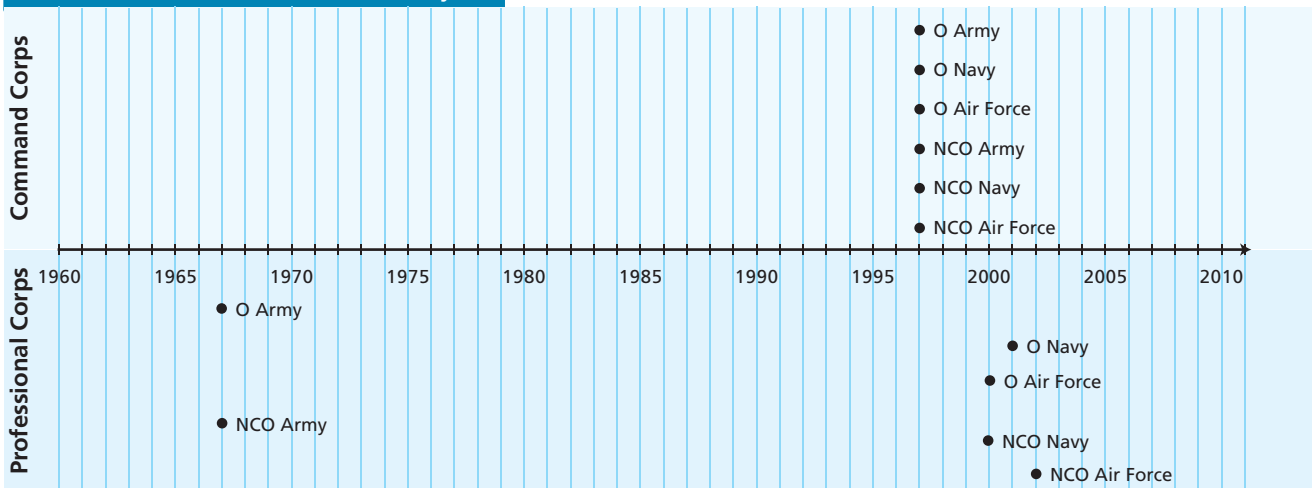

O: Officers - NCO: Non-commissioned Officers

**Note:** The Command corps includes officers who have been educated at military academies from the beginning of their professional careers. The Professional corps refers to those who develop a career in the civilian sphere and are then incorporated to the armed forces.

#### Women Officers who have reached the highest rank in the Command Corps (2010)

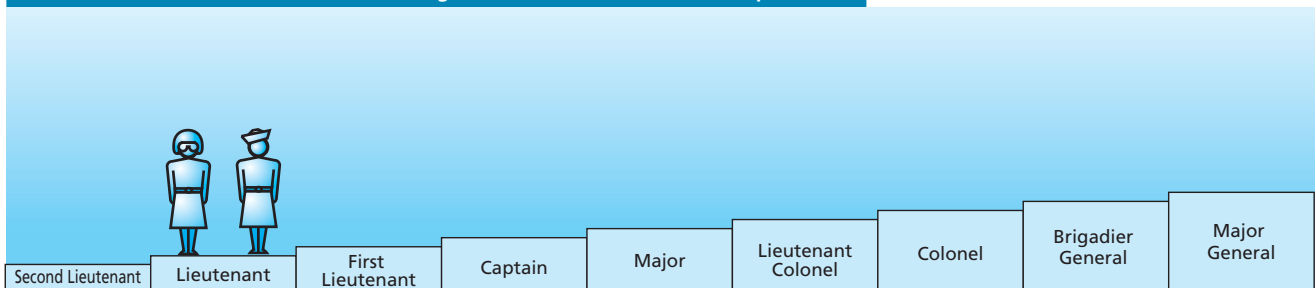

**Note:** These ranks correspond to the Army, as an example. The equivalent rank in the Navy is Lieutenant Senior Grade and Lieutenant for the Air Force. The Army has women Colonels, but they are officer specialists in health services; no active duty women serve in the combat branch.

**8.83% (1,316) of the total Armed Forces are women.**

**Source:** Information provided by the Ministry of National Defence an Project 07-184 Global Peace and Security Fund - RESDAL.

### Military Service

According to the Political Constitution, all Guatemalan citizens must serve and defend the Motherland. Likewise, the Ley de Servicio Cívico (Civic Service Act) establishes two modalities for the fulfilment of such obligation for a period of 18 months:

- Military Service (militarized nature).
- Social Service (civilian nature).

Number of Admitted and Discharges from Military Service			
Year	2009	2010 (January – April)	
Troops	Admitted	6,438	2,915
	Caused discharge	6,180	2,543
Specialists	Admitted	107	130
	Caused discharge	80	35

Guatemalan people older than 16 years old who attend high school may provide the Social Service in advance, by voluntarily participating in programmes led by their education centres, provided that such programmes are approved by the National Civic Service Board (Junta Nacional del Servicio Cívico) (*Ley del servicio cívico*, Sec. 42).

**Source:** Constitution, *Ley del Servicio Cívico* (Decree N° 20-2003 – 2003/05/12) and information provided by the Ministry of National Defence.

## Defence and National and International Community

### Participation in Peace Operations

Current Missions	Military Component			
	MEM		MC	
	Men	Women	Men	Women
MINUSTAH (Haiti)	-	-	133	13
MONUSCO ( Dem. Rep. of the Congo)	6	-	145	5
UNIFIL (Lebanon)	-	-	2	1
UNMIN (Nepal)	1	-	-	-
UNMIS (Sudan)	6	1	1	-
UNOCI (Ivory Coast)	5	-	-	-

MEM: Military experts on mission, including military observers, judge advocates and military liaison officers, among others - MC: Military Contingent.

**Source:** Compilation based on documents from the Department of Peacekeeping Operations of the United Nations. Data as of 31 August 2010.

Guatemala contributes 319 military troops to the United Nations peacekeeping missions, which represents 4.17% of the total contribution of Latin America.

The Regional PKO Training Centre, CREOMPAZ, headquartered in Guatemala, was founded in June 8, 2005.

In 2009, it trained 2,075 military troops and civilian groups on peacekeeping operations.



### Support Actions

The Army of Guatemala provided personnel, facilities, road security, medical equipment and transport for different activities performed in 2009:

Medical Conferences performed with the support of the US Armed Forces		
Date	Cared Patients	Participating Personnel
May –June	6,645	3 officers, 15 support specialists and 25 security soldiers.
June	2,044	3 officers, 6 support specialists and 10 security soldiers.
August	4,678	3 officers, 13 support specialists and 15 security soldiers.
August	4,780	5 officers, 19 support specialists and 35 security soldiers.
November	855	3 officers, 6 support specialists and 12 security soldiers.
Total invested cost: US\$ 15,593.		

With Humanitarian Assistance Programmes of the US SOUTHCOM, in coordination and collaboration with the Army of Guatemala, in January 2009 pit drilling projects were completed, which benefited 6,200 people in four municipalities.

### Medical Conferences performed with NGOs

Date	Patients	Specialty
February	2,560	General Medicine
April	2,500	General Medicine
April	650	General Medicine
May	138	Ophthalmology
June	Capanosa population	General Medicine
July	1,290	General Medicine
July	1,259	General Medicine

### Medical Conferences performed with Help International

Patients			
Ophthalmology	Dentist	Surgery	General Medicine
446	481	494	3,073

### Emergency Actions: Pacaya Volcano and Agatha Tropical Storm

2010	May 27	Pacaya volcano erupted. Immediately, the Army deployed 188 personnel in the area.
	May 28	947 soldiers were deployed to perform volcanic ash cleaning activities in Guatemala city and at La Aurora airport.
	May 29	The Emergency Operation Centre (COE) was activated in order to commence actions to mitigate material and personal losses caused by the Agatha storm.
	June	Volcanic ash cleaning operation. Supply transport operation in response to Agatha Storm. Cleaning operation in the Capital City.
	July	Sludge cleaning activities in response to Agatha. Activities of the Third Military Brigade "General Aguilar Santa María" in Jutiapa aimed to help population (infrastructure.)

### Security Force Support Activities

- Patrolling in cooperation with the National Civil Police.
- Specific task forces:
  - FT Guatemala
  - FT Interinstitucional Norte
  - FT Interinstitucional Occidental
- Special Reserve Corps for Citizen Security (CERSC).
- Support to operations in the fight against drug trafficking.
- Prison perimetral surveillance.

Within the framework of the governmental enquiry programme, four commitments were assumed in the different departments regarding the Ministry of National Defence for the coordination, together with the Administration, of citizen security operations. As of September 2010, services delivered are as follows:

- Installation of a military detachment in San Antonio Suchitepéquez, in the Suchitepéquez Department, for citizen security operations in the town and surrounding areas.
- Reopening of Playa Grande Military Command, in El Quiché Department.
- Creation of the VI Infantry Brigade "Colonel Antonio José de Irisarri," for the towns of Petén, Izabal and Huehuetenango.

### Preservation of the Maya Biosphere Reserve

The Army of Guatemala, through the First Infantry Brigade "General Luis García León" from Petén, is carrying out activities in coordination with other government institutions in that department, to protect the Maya Biosphere Reserve. In March 2010, 188 soldiers graduated as forest firefighters.

In August 2010, the President of the Republic announced the creation of a military battalion of 250 men for the purpose of protecting and recovering the Maya biosphere, located in the border with México and Belize. The mission is to combat deforestation of natural resources in an area considered an environmental key area (particularly the so called Laguna del Tigre).

The green battalion will be in charge of protecting the national border and exercising territorial control to prevent illegal drug trafficking.

**Source:** Website of the Army, information provided by the Ministry of National Defence, *Informe de rendición de cuentas, 2007* and Presidential Programme "Gobernando con la Gente".



Analysis:

## Guatemala's Armed Forces: 15 Years After Peace

### Gabriel Aguilera Peralta

*Academic and diplomat. Professor Emeritus at FLACSO Guatemala and Honorary President of the Institute for International Relations and Research on Peace (IRIPAZ).*

The 1996 Peace Agreements that put an end to war in Guatemala included a number of reforms that reached all the institutions of the nation. The idea was that political consensus could be the means to establish an alternative State model ensuring democracy and participation.

One of the Agreements involved the armed forces and expressed a need to reframe the Army. The agreement on the strengthening of civil society and the Army's role in a democratic society<sup>1</sup> contains conceptual-ideological commitments, a design of what the Army should be (and, hence, what it should cease to be) and the technical-operational commitments that would help implement those changes.

The first group of commitments included the definition of a democratic security agenda (as opposed to the national security agenda that had prevailed during the conflict), the constitution of a civilian National Police (the old national police had become just another arm of the Army during the insurgency war), the exclusion of the Army from domestic security issues and its restriction to national defence against external threats (up to that time it was understood as the guardian of both external defence and internal security), the separation of military intelligence from civilian intelligence

(since the Army had been managing both), the reform of the Constitution of the Republic to make civilians eligible to the positions of Minister and Deputy Minister of Defence (who according to legislation have to be military men), and the reform of military education to introduce democratic content and respect to human rights in the curriculum.

Among the technical-operational commitments, agreements were reached to dissolve a number of police-military corps associated with human right violations, as well as pro-government militias that were accused of the same crimes, reduce the Army's size and budget, introduce the voluntary military service and allow its substitution for social service, and create a Security Council and a civil intelligence agency. An additional commitment was the reform of Army's rules and regulations including the Military Code and the Army Constitution Act.

The idea was that, through the application of the Agreement, the country would be demilitarized and the Army would turn into a downsized institution optimized in its external defence role, respectful of democratic principles and human rights.

Like with all Peace Agreements, fifteen years later a part of the commitments were met, another part has turned into more or less permanent processes and

<sup>1</sup> AFPC --*Acuerdo de Fortalecimiento del Poder Civil*

there are still others that remain to be achieved.

The main shortcomings are reflected in the impossibility to implement the constitutional reforms, since the referendum held towards this end resulted in a negative vote, which impeded the civilian command of the Army. Great difficulties were encountered in the attempt to create and consolidate a civilian national police with democratic values, owing to the fact that part of the old police remained with the force, which was later on permeated by organized crime. Nor was a clear-cut separation of domestic security and external defence tasks attained.

Similarly, a reduced and modern armed force with high mobility, modern weapons and equipment, with the ability to assume external defence missions is still an unmet objective. Army men were reduced in numbers by successive administrations down to the current approximately 14,200 troops. At the same time, allocating resources to the renovation and modernization of weapon systems and equipment has proved impossible up to now. The ground force continues to be equipped with the means that it employed during the internal war, including armoured vehicles manufactured in Guatemala, while the air and sea forces are availed of even more reduced means: old vessels and aircraft and scarce capabilities. Negotiations for the acquisition of six-Super Tucan system have started recently.

The Army's tight financial resources have resulted in the budget being used mainly for personnel salaries and sustainment, with little left for operations and nothing for equipment renovation. The lack of resources is related to the State's own scarcity and dire social needs. In addition, military financial resources have been subject to large embezzlement and fraud operations.

As regards military education reform and the change of officer corps' mindset, more information is needed to assess any progress, although high command personnel turnover and payroll reductions, the number of officers in active service remaining from the days of the war is relatively small. However, being an ideological issue, conservative visions seem to persist.

Among the positive evolutions, the achieved demilitarization is worth of note. The Army no longer has any political influence on State administration, officers are subject to the ordinary justice system and there are even former high-rank officers imprisoned under common crime charges. The Army is no longer isolated from other society actors: although with difficulty, it has partaken in plenty civil society interaction spaces, including (even with difficulties) the exercise of de-

signing a "Security Policy for Democracy" organized by WSP. The National Defence Book, the new defence policy and other Army regulation instruments have been developed with the participation of the civil society and the institution maintains the permanent "Defence Community" forum for civil-military discussions.

On the other hand, central institutions have been created to strengthen civilian control of security and intelligence, particularly the National Security System. The Guatemalan civil society is the best educated in security and defence matters and the most capable of exercising a certain influence, in all Latin America.

One of the main missions the Army keeps participating in is peace operations. Its main deployments are a Military Police unit in Haiti and a strike force-type unit in Congo, where it has even gone through combat actions and suffered casualties.

Other security issues than those it sought to overcome through the Agreements are besieging Guatemala fifteen years after peace: A succession of natural disasters have taken human lives and caused huge material damage, very difficult to recover. Criminal violence is one of the highest in Latin America. This is partly related to the so called "illegal and clandestine security bodies and apparatuses", transformed into organized crime from the counterinsurgency warfare system, as well as the expansion of Mexican drug cartel activities. Organized crime has had the ability to pervade into State structures and several Guatemalan governments have requested United Nations' assistance for justice administration, through an unprecedented experience known as the "International Commission against Impunity." (CICIG).

This grave security situation has led several administrations to bring the Army back to domestic security actions, by issuing legislation and reversing the territorial reduction that had been implemented after the signing of the Agreements. Military bases in the interior of the country have been reopened as part of the effort to recover the areas where drug trafficking organizations have settled. This is an example of how new situations impact on the provisions of the Agreements and it lends to interpretation under George Downs' increasing complexity theory which states that the more time elapses after the peace process has finished, the higher the probability that new elements may have an effect on the evolution of the process.<sup>2</sup>

<sup>2</sup> See George Downs and Stephen Stedman, "Evaluation issues in Peace Agreements" in *Ending Civil Wars. The Implementation of Peace Agreements*, ed. Stephen Stedman, (Boulder, Colorado: Lynne Rienner Publishers, 2002).





# Honduras

## The Legal Framework and the Defence System

### National Legislation

#### Systems and Concepts

- Constitutive Act of the Armed Forces (Decree N° 39-2001 - 2001/10/29/)

#### Military Organization

- Military Code (Decree N° 76 - 1906/03/01. Last amendment: Decree N° 47 - 1937/01/22)  
 - Military Service Act (Decree N° 98-85 - 1985/08/22)  
 - Personnel Act for the Members of the Armed Forces (Decree N° 231-2005 - 2005/10/11)  
 - Military Security Service Institute Act (Decree N° 167 - 2006/11/27)

— Advisory and assistance functional relationship  
 — Command reporting line

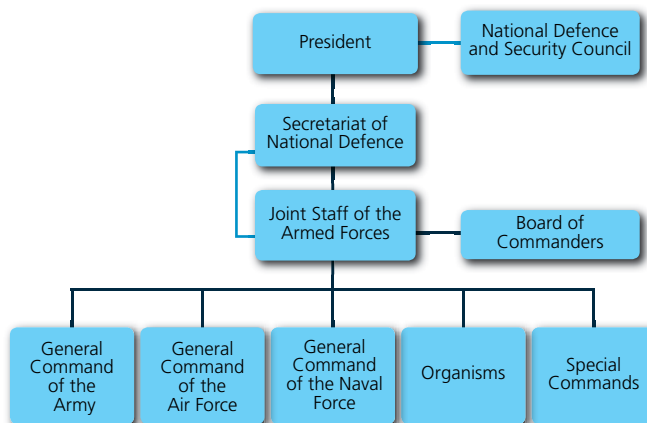

The President may receive the advice of the National Defence and Security Council and holds the command of the Armed Forces, either directly or through the Secretary of Defence, who in turn has the Joint Staff as the highest military technical body for advice, planning, coordination and supervision. The Board of Commanders is the consultative body, composed of the Chairman and the Vice Chairman of the Joint Chiefs of Staff, the Inspector General of the Armed Forces and the General Commanders of the Armed Forces. The Congress holds the powers granted by the Constitution and permanently monitors defence related issues through the National Defence Committee.

Source: Compilation based on the legislation above mentioned. For constitutional provisions see Chapter 1.

Source: Compilation based on the Political Constitution, *Ley constitutiva de las Fuerzas Armadas* (Decree N° 39-2001 - 2001/10/29) and *Libro Blanco de la Defensa Nacional*, 2005.

## The Budget

Year	Defence Budget (in US\$)	Government Budget (in US\$)	GDP (in US\$)
2006	63,175,260	2,166,132,003	8,413,000,000
2007	86,837,651	2,499,174,091	10,059,000,000
2008	121,183,088	3,167,154,298	13,779,000,000
2009	127,963,147	3,377,085,767	14,581,000,000
2010	172,194,128	3,598,658,227	15,288,000,000

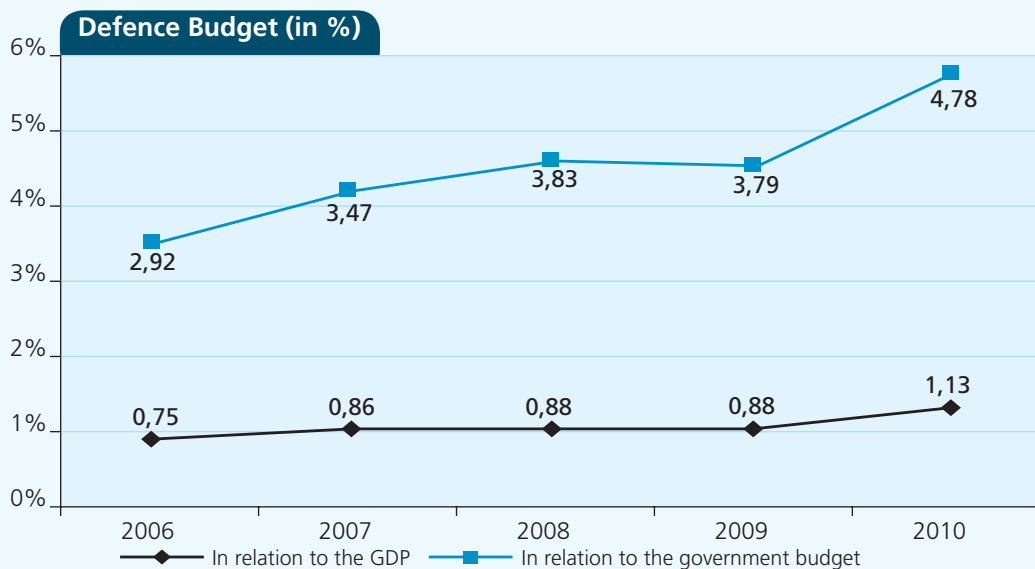

### Defence Budget Breakdown

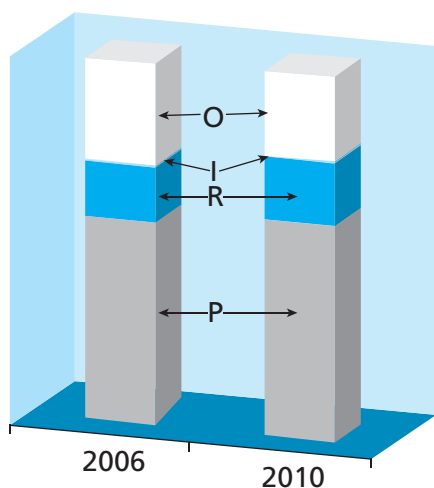

**P:** Salaries and other benefits  
**R:** Retirement and pension funds / **I:** Investment  
**O:** Other expenses

### Comparative Increase (% variation 2006-2010)

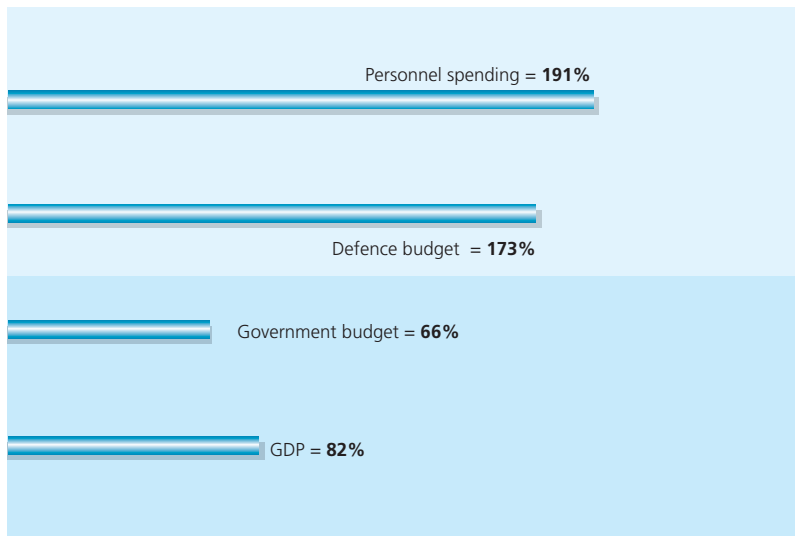

### Defence Budget 2010 (in Local Currency)

Institutions	Personnel Services	Non-personnel services	Materials and Supplies	Others*	TOTAL
<b>Secretariat of National Defence</b>					
Central Activities	169,987,110	8,246,500	16,054,712	38,285,250	232,573,572
Army	942,202,231	18,332,272	187,528,163	2,469,500	1,150,532,166
Air Force	253,533,869	8,556,167	46,155,850	1,439,800	309,685,686
Naval Force	170,294,887	9,028,536	52,952,690	496,600	232,772,713
Joint Chiefs of Staff	363,976,603	20,919,246	31,597,664	251,470,250	667,963,763
<b>Military Prevision Institute**</b>	54,140,557	28,939,038	4,669,332	583,523,834	671,272,761
<b>TOTAL</b>	<b>1,954,135,257</b>	<b>94,021,759</b>	<b>338,958,411</b>	<b>877,685,234</b>	<b>3,264,800,661</b>

\* Includes goods subject to capitalization, transferences, financial assets and public debt service.

\*\* Since 2007, policemen and firefighters are being incorporated as members of the IPM (Military Prevision Institute). No budget allocation breakdowns are available on this subject. The IPM's financial assets are not included in the breakdown. The Defence Secretariat's contribution to the IPM is deducted from "Others".

### Composition of Defence Budget 2010

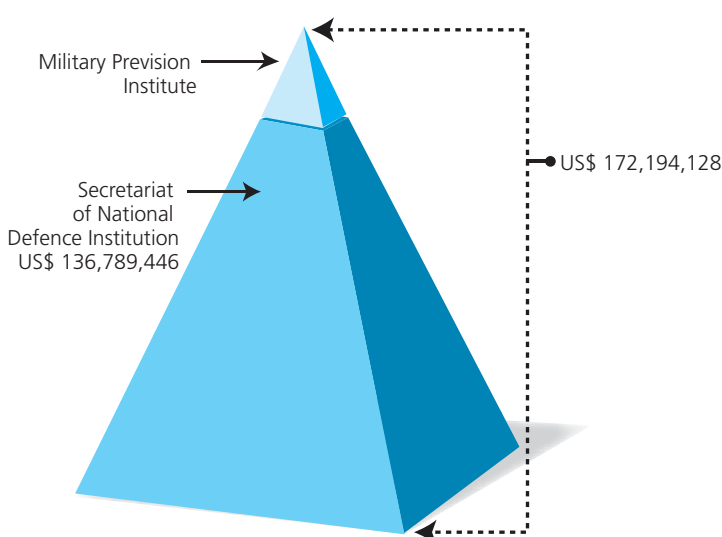

Between 2007 and 2009, military acquisition contracts signed with the United States amounted to US\$ 15,917,975. Such amount represents 4.74% of the allocated defence budget for those years.

**Source:** Compilation based on Decreto-Ley de presupuesto de ingresos y egresos de la República, para el ejercicio fiscal 2006, 2007, 2008, 2009 and 2010. The State Budget passed by the Congress by means of the above mentioned Act is considered herein. The concept of investment is that expressed in "Capital assets acquisition". Acquisitions: Just the Facts (Center for International Policy, Latin American Working Group Education Fund and Washington Office on Latin America).  
 GDP: Projection of the World Economic Outlook Database, IMF, of each year under review. This source has been taken for comparative purposes. Each country prepares the budget based on its own GDP estimation. The dollar value considered corresponds to the exchange rate determined by the World Economic Outlook Database, IMF, for each year under consideration. As of July, the 2010 exchange rate average is 19.03 Lempiras, based on the data provided by the Central Bank of Honduras. For further calculations, figures are provided in local currency. Expressions in Bold Type (Table) make reference to the various defence budget items, which can be found in a sector-based or institutional classification of the Budget Act.



**The Secretary of National Defence**

**Responsibility:**

It ensures that the national defence policy is duly executed by the Armed Forces; it represents Honduras at international defence bodies; and it authorizes, regulates and controls all matters related to weapons, ammunitions and explosives. In relation to military matters, it is the administrative organization of the Armed Forces; it countersigns decrees, agreements, orders and decisions; it secures the preparation and implementation of plans and programs, and orders their elaboration or update; it recommends officer promotions to the President; and supervises, inspects and exerts control over the organization and performance of the Armed Forces. (Ley constitutiva de las Fuerzas Armadas, Decree N° 39-2001 – 2001/10/29, Sec.

**Organization Chart**

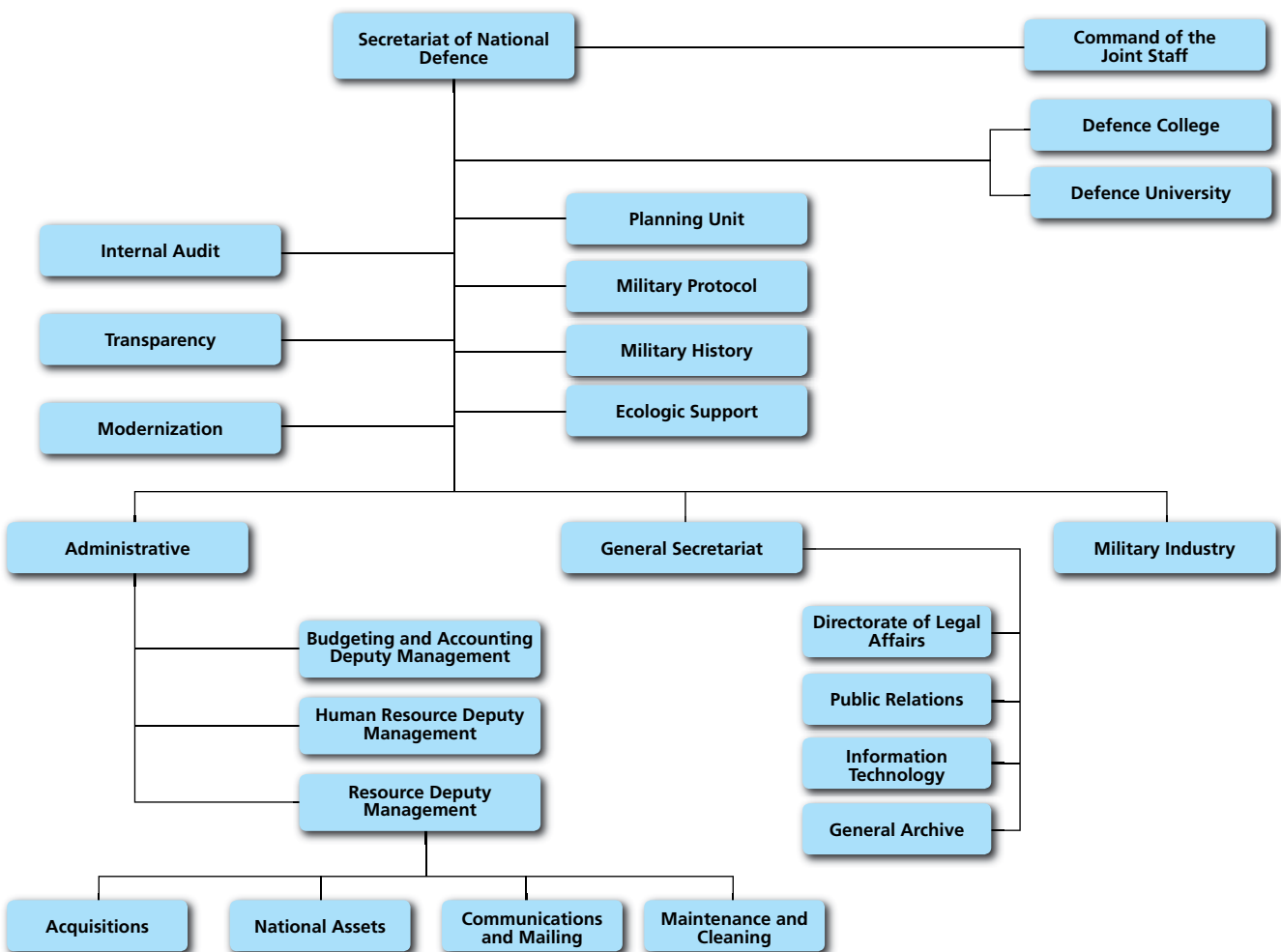

<b>Date of Foundation:</b> 1954
<b>Current Minister (September 2010):</b> Marlon Pascua Cerrato
<b>Can military members be Ministers of Defence?:</b> Yes (if they have retired)
<b>Number of military members who were Ministers of Defence:</b> None (since 1998, year of the constitutional reform)
<b>Number of civilians who were Ministers of Defence:</b> 4 (since 1998, year of the constitutional reform)
<b>Have there been any women in charge of the Ministry of Defence?:</b> No
<b>Average permanence in the Minister of Defence position:</b> 2 years and 9 months

[The Minister currently in charge is not considered. The creation date is related to the moment in which the term "Defence" becomes part of the Institution's name]

Source: Compilation based on information provided by the websites of the Government of Honduras and the Secretary of National Defence.

**Political Definitions**

**Policy Guidelines**

**Country Vision**

The second national objective of the Country Vision's four tenets (*Visión País*) is as follows:  
 "A Honduras developed in democracy, with security and free of violence."

**Scenario**

By 2038, Honduras will continue growing as a representative and participative democracy, making use of plebiscites and referendums as a means for citizen involvement in the country's most relevant matters. Its population and rights shall be effectively acknowledged and shall be entitled to an integrated, effective and expedite justice system and a secure environment with low levels of criminality. The system of property rights shall be consolidated and all land-dwellers shall be granted an ownership deed. The State shall have modern security corps supported by intelligence and integral systems, and by solid and coordinated institutions. The Armed Forces shall be guarantors of the Constitution and the defence of our sovereignty. The preservation and defence of freedom of expression, and individual and economic freedoms shall be an essential duty of the State.

**Goals**

1. Seven continuous and transparent democratic electoral processes since 2009.
2. Reduce criminal activity to levels below the international average.
3. Lower the social conflict index to less than 6.
4. Decrease the index of illegal land occupation to less than 5%.
5. Improve border protection as a condition for external deterrence and increase of internal confidence.

**"Security as a Requirement for Development" Strategic Guideline**

Honduras forms part of an insecurity landscape which includes Mexico and Central America, produced by organized crime and its transnational networks. This reality obliges the country not only to enter into international alliances with the aim of increasing the effectiveness of its actions to combat these crimes, but also to improve the protection of national borders and areas of the national territory used by criminal gangs with relative impunity. The protection of national borders is considered as a condition necessary to strengthen the deterrence of external attacks against national security and, at the same time, a requirement to increase and reinforce internal confidence in the effective fight against insecurity.

Some of the major challenges are:

- Reinforce the protection of national borders, as well as the presence of the armed forces and national police in the areas of the country where criminal gangs linked to organized crime and drug trafficking operate.
- Adhere to, and involve the country in, international initiatives aimed at combating this scourge to domestic security.

**Budget Objectives for the Defence Sector**

- Protected forests and nature.
- Ensure the efficient use of resources to support forest protection.
- Keep peace in the Republic and defend territorial integrity.
- Logistics advice in the fight against drug trafficking.
- Transformed Armed Forces.
- National Police supported by intelligence operations.
- Train young people through the educational military service.
- Train military elements in emergency management caused by natural disasters.
- Train military elements in debris removal, repair of communication routes and public service installation.

Source: Decreto Ley 286- 009 para el Establecimiento de una Visión de País y la Adopción de un Plan de Nación para Honduras and Decreto-Ley de presupuesto de ingresos y egresos de la República para el ejercicio fiscal 2010.

Honduras published the *Libro de la Defensa Nacional* (National Defence Book) in 2005.

**Reports submitted to the United Nation and the OAS**

1997	1998	1999	2000	2001	2002	2003	2004	2005	2006	2007	2008	2009
	✘	✘	✘	✘	✘	✘						
					◊			◊				
				●	●							

Register of Conventional Arms: ✘ Register of Military Expenditures: ◊ Implementation of Confidence and Security Building Measures: ●

Source: Compilation based on reports submitted to the United Nations Register of Conventional Arms and the United Nations Instrument for Reporting Military Expenditures and reports submitted to the OAS on the Implementation of Confidence and Security-Building Measures.



**Military Career**

**Commissioned Officers' Career Path<sup>1</sup>**

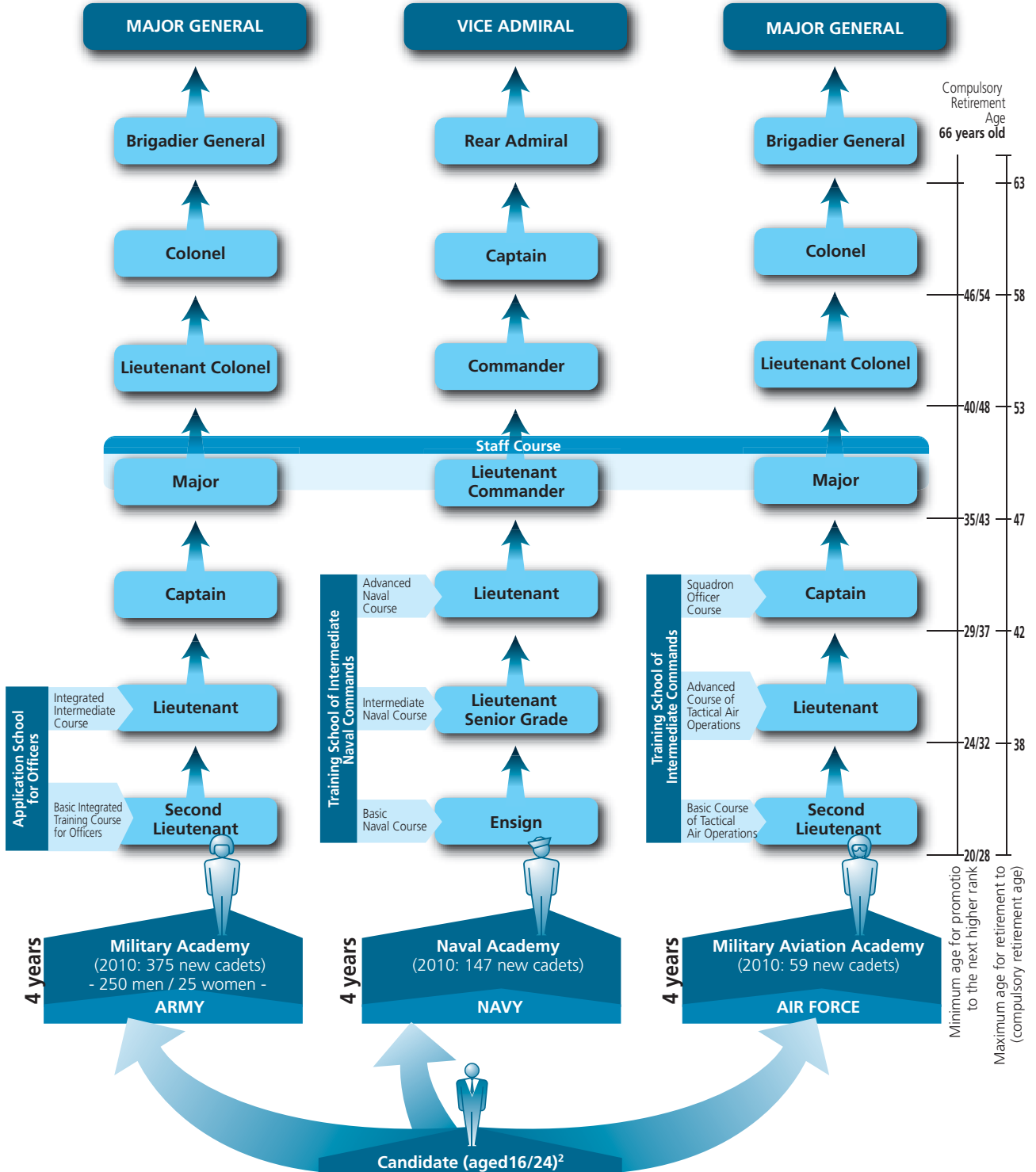

<sup>1</sup> Command corps includes officers who have been educated at military academies from the beginning of their professional careers. The graph makes a theoretical reconstruction of officers' promotion through the completion of mandatory courses. Further requirements for promotion have not been considered.

<sup>2</sup> Ages 16-24 years have been considered for comparative purposes. Entry age varies depending on the service: Army up to 22 years old, Air Force, from 16 to 24 years of age. The minimum age for promotion will depend on the age of graduation from the military institution.

**Source:** Compilation based on *Ley de personal para los miembros de las Fuerzas Armadas* (N° 231-2005 - 2005/10/11) - New cadets: Armed Forces of Honduras.

### The Armed Forces

#### General Mission

The Armed Forces are formed to defend territorial integrity and sovereignty of the Republic, maintain peace, public order and the respect for the Constitution, the principles of free vote and rotation of the Presidents of the Republic. They shall cooperate with the National Police to keep public order. They shall cooperate with the Secretaries of the State and other institutions, at their request, in tasks related to literacy, education, agriculture, protection of the environment, road systems, communications, health and agriculture reform. They shall participate in international peace missions, based on international treaties; provide logistic support on technical advice, communications and transportation in the fight against drug trafficking. They shall cooperate with personnel and means to face natural disasters and emergency situations which impact people and assets; as well as in protection and conservation programs for the ecosystem, and academic and technical training of their members, and other matters of national interest. They shall also cooperate with public law-enforcement agencies, at the request of the Secretary of Security, to fight terrorism, arms trafficking and organized crime, as well as in the protection of the powers of the State and Elections Court, at the request of these, in their installation and operation. (Constitution, Sec. 272 and 274)

#### Specific Missions

##### Army

The Army is the Service responsible for defending the territorial integrity and sovereignty of the Republic in the land space.

##### Navy

The Navy contributes to the compliance with the constitutional mission established for the Armed Forces, mainly in the maritime, fluvial and lacustrian space and in the insular territory, maintaining the security and control of the sea coasts and borders and preserving maritime resources in territorial waters, in adjacent areas, exclusive economic zone and in the continental shelf.

##### Air Force

The Air Force contributes to defending the territorial integrity and sovereignty of the Republic especially regarding the air space.

**Total Strength: 8,566\***

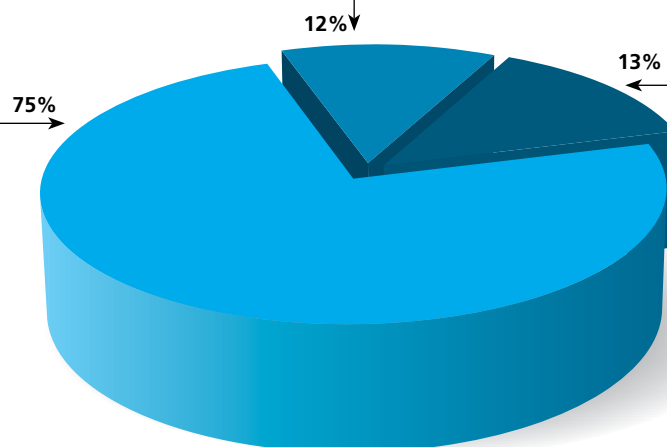
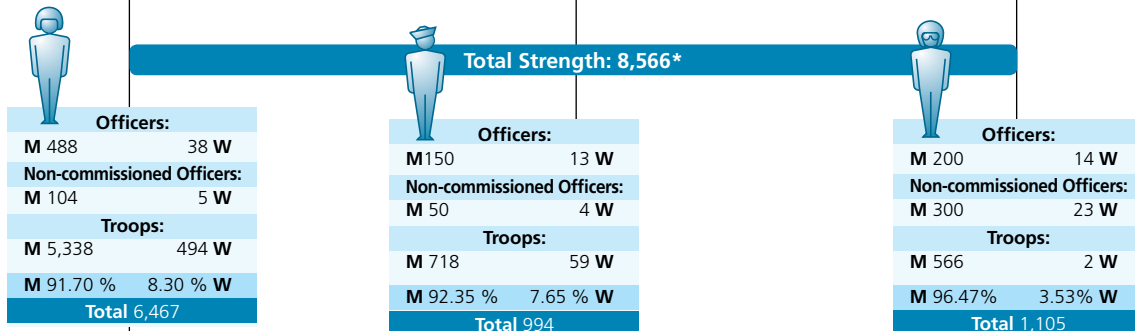

M: Men / W: Women

\* 2009 data.

Source: Ley constitutiva de las Fuerzas Armadas (Decree N° 39-2001 – 2001/10/29) (missions) and information provided by the Joint Staff of the Armed Forces: C-I Human Resources (regular force).



**Women in the Armed Forces**

**Women's Admission to the Armed Forces (year)**

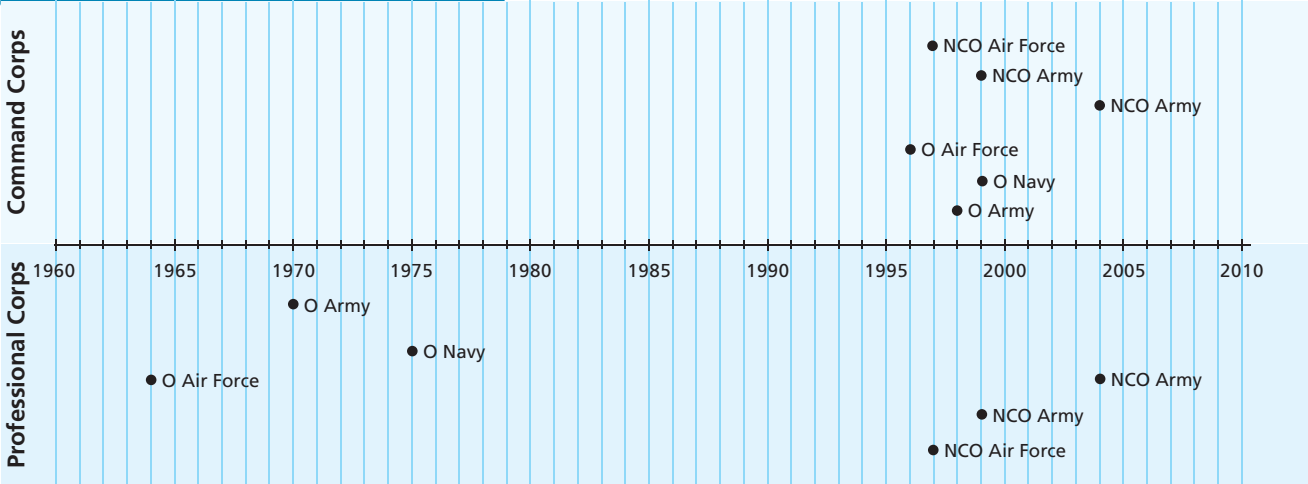

O: Officers - NCO: Non-commissioned Officers

**Note:** The Command corps includes officers who have been educated at military academies from the beginning of their professional careers. The Professional corps refers to those who develop a career in the civilian sphere and are then incorporated to the armed forces.

**Women Officers who have reached the highest rank in the Command Corps (2010)**

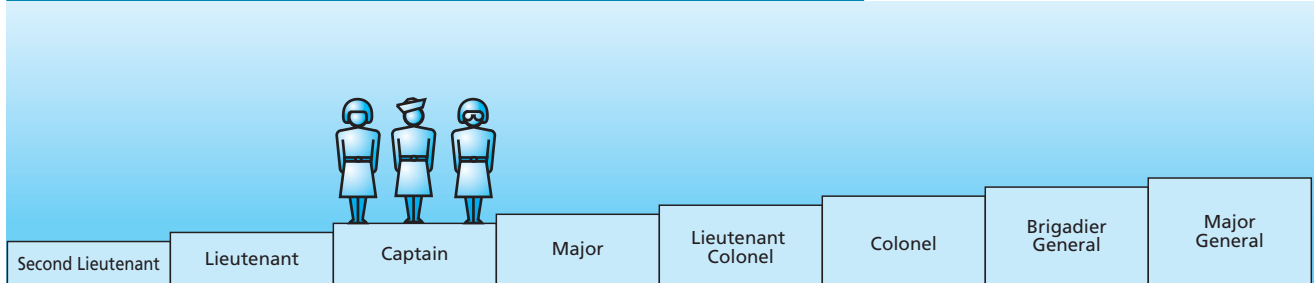

**Nota:** These ranks correspond to the Army, as an example. The equivalent rank for Captain is the same in the Air Force and Lieutenant in the Navy.

**7.61 % (652) of the total Armed Forces are women.\***

\* Data for 2009

**Source:** Information provided by the Air Force Headquarters, Navy Headquarters, and the Joint Staff and Project 07-184 Global Peace and Security Fund-Resdal.

**Military Service**

According to the Constitution, it is voluntary in times of peace, under a social, humanitarian and democratic education system. The State can summon the troops, in accordance with the Military Service Law. In case of international war, all Honduran citizens capable of defending and service the Fatherland shall be soldiers.

Military service duration is 2 years. Entrance requirements are as follows:

- Register with the Military Register
- Pass the entrance examination.
- Pass the medical examination.

Pursuant to Military Service Decree No. 98, the provision of military service in times of peace may be compared or partially compared to certain professions, including some professions involving social service practices, which are under the Armed Forces' control and command.

**Source:** Constitution and *Ley del servicio militar* (Decree N° 98-85 – 1985/08/22).

## Defence and National and International Community

### Participation in Peace Operations

Current Missions	Military Component			
	MEM		MC	
	Men	Women	Men	Women
MINURSO (Western Sahara)	12	-	-	-

MEM: Military experts on mission, including military observers, judge advocates and military liaison officers, among others - MC: Military Contingent.

The Regional Peacekeeping Training Centre (CREOMPAZ), based in Guatemala, was created in June 8, 2005.

Troops from Honduras participating in UN peacekeeping missions receive training in the regional centre.

**Source:** Compilation based on documents from the Department of Peacekeeping Operations of the United Nations. Data as of 31 August 2010.

Honduras contributes 12 military troops to the United Nations peacekeeping missions, which represents 0.16% of the total contribution of Latin America.



## Support Actions

### Fight Against Drug Trafficking

The Armed Forces of Honduras cooperate with the National Security Secretariat in the fight against drug trafficking, gangs or *maras*, regular crime, terrorism, organized crime and weapon and human trafficking.

### Forest Protection Programme

This programme is aimed at reducing forest fire rates; deforestation levels; improve the country's forest cover; support sustainable natural resource management projects; and increase efforts on environmental education programmes.

#### Results:

Fire fighting action in 239 forest fires; 15 clandestine sawmills dismantled; 500 meters dredged benefiting 2,000 families; 831 hours of support flights for Forest Protection operations, reforestation of 2,667 hectares with 83,625 different plant species planted.

### Education

The Armed Forces cooperate with the Education Secretariat in literacy, education, student census, school text and furniture distribution, education facility security campaigns, among others.

Likewise, based on the importance of enhancing training level on defence subjects in the different areas of the national education system, with special focus on graduate, postgraduate, training and updating courses for civil and military personnel, over 500 professionals have graduated from the National Defence College.

### Infrastructure

- The Armed Forces, together with the Public Works, Transport and Housing Secretariat, is in charge of opening and maintaining roads and highways, reconstructing public works, and supporting low income communities.
- (September 2010) Strength (officers, troops, and an entire engineering module) carried out cleaning and clearing works in market streets affected by heavy rains in San Isidro, Colon, Álvarez and Las Américas areas.

### Natural Resources

- The Armed Forces cooperate with the State Secretariat of Natural Resources and the Environment (SERNA) in the fields of protected areas, illegal wood cutting, wildlife protection, forest firefighting and reforestation, considering these tasks as one of the institution's priorities.
- Air, land and water patrolling in the Biosphere Reserve Area of the Plátano, Tahuaca and Patuca Rivers.

### Health

- (October 2010) Health Fair: The Armed Forces help those in need through medical brigades especially focused on the following areas: general medicine, pediatrics, gynecology, and dental care. Medicine delivery to patients, as required.
- (July 2010) The Armed Forces actively participated in fumigation campaigns, abatization and cleaning activities in population areas with the highest risk of getting dengue (Francisco Morazán, Atlántida, El Paraíso, and Choluteca.) The entire population was invited to participate in the activities aimed at raising awareness and engaging them in the fight against the disease by maintaining their houses clean, not leaving water-filled containers in their back yards, and keeping the entire community in clean conditions to help prevent the reproduction of the dengue transmitting vector.
- (July 2010) Activity coordinated by the Directorate of Civil Affairs, with cooperation of personnel from the Directorate of Military Healthcare, Military Hospital, Army, Air Force and Navy troops, as well as auxiliary personnel from the Joint Staff. Nuevo Tiempo community residents received general medical assistance, pediatrics, gynecological, dermatological, and dental care, and the pertinent medication was given to those requiring it.
- (May 2010) Army's Infantry Brigade 120 launched the Vaccination Campaign at Santa Rosa de Copán Daycare Center, as part of the National Child Vaccination Day. The purpose of this campaign was to control, eliminate and eradicate preventable diseases by the application of vaccines to high risk groups. The vaccines applied included TB, polio, measles, and hepatitis B.

**Source:** *Libro de la Defensa Nacional de Honduras*, 2005, website of the Armed Forces and *Informe de Evaluación Física Financiera*, Secretary of National Defence, 2008.





Analisis:

## Political System, Armed Forces and Interruption of Constitutional Order

**Leticia Salomón**

*Researcher of the Honduras Documentation Center (CEDOH)*

■ On June 28, 2009, a coup d'état in Honduras interrupted the constitutional order and introduced a crack in the democratic construction process that had commenced in the early 1980s and acquired momentum in the 1990s, when a set of reforms eliminated mandatory military service, set the Police out of military jurisdiction and reinstated civilian control over key institutions which the military had taken hold of during the preceding decade under arguments of national security, including Hondutel --the national telecommunications company--, the Merchant Marine, the Migrations Directorate and the National Geography Institute.

The current Constitution of the Republic, approved in 1982, quite accurately reflects the historical context in which it was approved, with armed forces deformed by the cold war and reaffirmed in their condition as arbitrators of political and social conflict, with multiple functions that went far beyond defence. The reformation process driven during the government of the Liberal President Carlos Roberto Reina (1994-1998), promoted the return of the military to quarters detaching them from the other State institutions

and civilian society, with which they had confronted through coups d'état, forced and arbitrary recruitment and human rights violations.

The Honduran armed forces always blamed the Liberal Party and, more specifically, President Reina, for the deprivation of their privileges, which they had become much too accustomed during the preceding decades when they had operated as the center of the country's political system. However, their discontent notwithstanding, this process allowed the armed forces to recover their prestige with society since, step by step, their essential role as defenders of the territory's sovereignty and integrity, and their support to the population in the event of natural disasters was steadily being acknowledged. Even against their own wishes, staying away from the State and the society allowed them to acquire legitimacy and to cease being perceived as a threat to the country's social and political stability.

On June 28, 2009, the Honduran armed forces, after violating their constitutional mandate of being a professional, law abiding, apolitical and non-deliberating institution, decided to support, through the use of

arms, a group of business, professional, media and religious elements who took to overruling the citizenry's decision to elect a President to govern for a four-year term. And they did it willingly, knowing that they would thus regain lost privileges and obtain, from the politicians involved in the coup d'état, a portion of the spoils of the State they were ready to pillage. Honduran military received millions-worth funds before, during and after the coup, of which they have rendered no account to anybody and have recovered control over certain civilian institutions that had been 'taken away' from them as a result of the reforms of the 1990s.

Motivated by their own particular interests and egged on by politicians and businessmen with cold-war mentalities and an instrumental vision of the armed forces, they decided to dump the legitimacy acquired and implemented their vision of the enemy, associating it to social protest and obtaining "successes" they had been unable to attain in their natural functions for territorial integrity defence, over unarmed civilians that were exercising their constitutional right to demonstrate their opposition to the coup d'état.

The business, political, media, religious and military alliance that perpetrated the coup d'état, revived the cold-war ghosts, argued that it was protecting an endangered democracy, defended itself with the aged arguments of threats to the Occidental and Christian way of life, and set itself to persecute civilians under the pretence of saving the Motherland. A continuous repetition of messages justifying the coup, from most of the media involved in it, manipulated public opinion and the national conscience of a number of candid analysts 'informed' by the media duly aligned with the most conservative elements of the Catholic and Evangelic churches, who justified the coup from the pulpit, spurring citizens' fear of the apocalypses they themselves had created to attain their objectives.

The June 2009 coup d'état revealed the weaknesses of the restitution process for civilian control over the military, which was also evinced in the imprisonment order against the constitutional president by the Supreme Court of Justice sent directly to the Chief of the Armed Forces; the request of the president of the Legislative to that same Chief for him to "comply with his duty" to give the coup d'état; the show of force of retired and active military men in open deliberation over the behaviour of their Commander-in-Chief;

the public appearance of the chief of the institution by the side of the *de facto* president on public settings where the coup d'état was purportedly being legitimated; and, finally, the lack of transparency and no rendering of accounts of the use of public moneys employed by the armed forces to fund the coup d'état and the speed with which they recovered civil key institutions and called the then president elect to quarters, who rushed to give signs of good behaviour according to the new rules of the political game.

What happened in Honduras in 2009 brought to the surface the weakness of State institutions manipulated by political leaders imposing their particular interest as though they were the interests of society at large. But it also showed that the armed forces will continue to be a threat to political and social stability, as long as their role is not clearly defined and the process of subordinating them to constitutionally elected authorities has not been completed. To this end, the following pending issues have to be addressed:

- Review and reform the constitutional articles that assign arbitration roles to the armed forces.
- Ensure military submission to elected democratic governments.
- Reaffirm the State and society demilitarization process
- Ensure legal punishment to the military men who broke the constitutional order and could break it again.
- Start legal actions against military men for human right violations since the coup d'état of June 2009.
- Develop programs for civilian education on defence at civilian universities.
- Review and re-express the study plans at the University for Defence and other educational instances, to ensure military education and training within the framework of civilian rule.
- Ensure transparency and account rendering in budgetary execution by the armed forces.
- Initiate politician training on civilian conduct of defence.



# Mexico

## The Legal Framework and the Defence System

### National Legislation

#### Systems and Concepts

- Act to preserve the Country's Neutrality (DOF 1939/11/10)
- Organic Law for Federal Public Administration (DOF 1976/12/29, Last amendment: DOF 2009/06/17)
- National Security Act (DOF 2005/01/31, Last amendment: DOF 2005/12/26)
- General Act on the Public Security System (DOF 2009/01/02)

#### Military Organization

- Navy General Ordinance (DOF 1912/01/08)
- Discipline Act of the Mexican Army and Air Force (DOF 1926/03/15, Last amendment: DOF 2004/12/10)
- Organic Act of Military Courts (DOF 1929/06/22, Last amendment: DOF 1931/02/24)
- Code of Military Justice (DNL N° 005 - 1933/08/31, Last amendment: DOF 2005/06/29)
- Military Service Act (DOF 1940/09/11, Last amendment: DOF 1998/01/23)
- Act which creates the Army and the Air Force University (DOF 1975/12/29)
- Reward Act for Navy of Mexico (DOF 1985/01/14)
- Organic Law of the Army, Air Force and Navy National Bank (DOF 1986/01/13, Last amendment: DOF 2002/06/24)
- Organic Law of the Mexican Army and Air Force (DOF 1986/12/26, Last amendment: DOF 2009/06/12)
- Discipline Act for the Personnel of the Navy of Mexico (DOF 2002/12/13)
- Organic Act of the Navy of Mexico (DOF 2002/12/30, Last amendment: DOF 2009/06/12)
- Act on Promotions and Rewards of the Mexican Army and Air Force (DOF 2003/10/30, Last amendment: DOF 2009/06/12)
- Act for the Armed Forces Social Security Institute (DOF 2003/07/09, Last amendment: DOF 2008/11/20)
- Act on Firearms and Explosives (DOF 1972/01/25, Last amendment: DOF 2004/01/23)
- Act for checking, adjusting and calculating the Services for the Mexican Navy (DOF 2004/06/14, Last amendment: DOF 2009/06/12)
- Promotions Act for the Navy of Mexico (DOF 2004/06/25, Last : DOF 2009/06/12)
- Military Education Act for the Mexican Army and Air Force (DOF 2005/12/23)
- Act for checking, adjusting and calculating the Services in the Mexican Army and Air Force

Source: Compilation based on the legislation above mentioned. For constitutional provisions see Chapter 1.

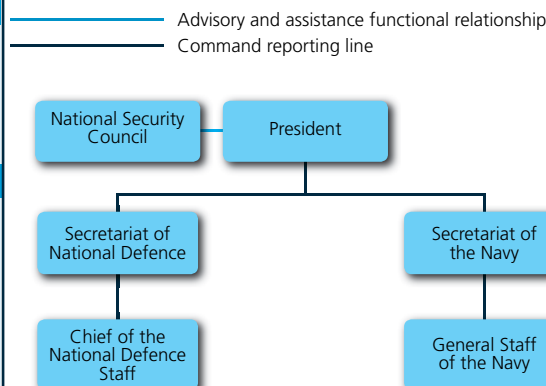

The President convenes the National Security Council, composed of the Secretaries of Government, Defence, Navy, Public Security, Economy and Public Credit, Public Service, Foreign Affairs and Communication and Transportation, the Attorney General of the Republic and the General Director of the National Research and Security Centre, as a deliberative body to establish and articulate the relevant policies. The Secretary of Defence holds the High Command of the Army and the Air Force, and the Secretary of the Navy commands the Mexican Navy. Each Secretary has a Staff as a technical and operational body for the accomplishment of their functions. The Congress holds the powers granted by the Constitution and permanently monitors defence related issues through the defence committees in both Houses.

Source: Compilation based on the Political Constitution, *Ley orgánica de la administración pública federal* (DOF 1976/12/29. Last amendment: DOF 2009/06/17), *Ley orgánica de la Armada de México* (DOF 2002/12/30. Last amendment: DOF 2009/06/12), *Ley orgánica del Ejército y la Fuerza Aérea* (DOF 1986/12/26. Last amendment: DOF 2009/06/12), and *Ley de seguridad nacional* (DOF 2005/01/31. Last amendment: DOF 2005/12/26).

## The Budget

Year	Defence Budget (in US\$)	Government Budget (in US\$)	GDP (in US\$)
2006	3,288,106,264	136,687,280,283	743,073,000,000
2007	4,184,285,440	150,591,242,067	886,441,000,000
2008	4,706,150,462	173,350,821,168	949,576,000,000
2009	4,681,259,477	170,865,419,735	866,336,000,000
2010	4,875,854,577	184,312,515,198	995,918,000,000

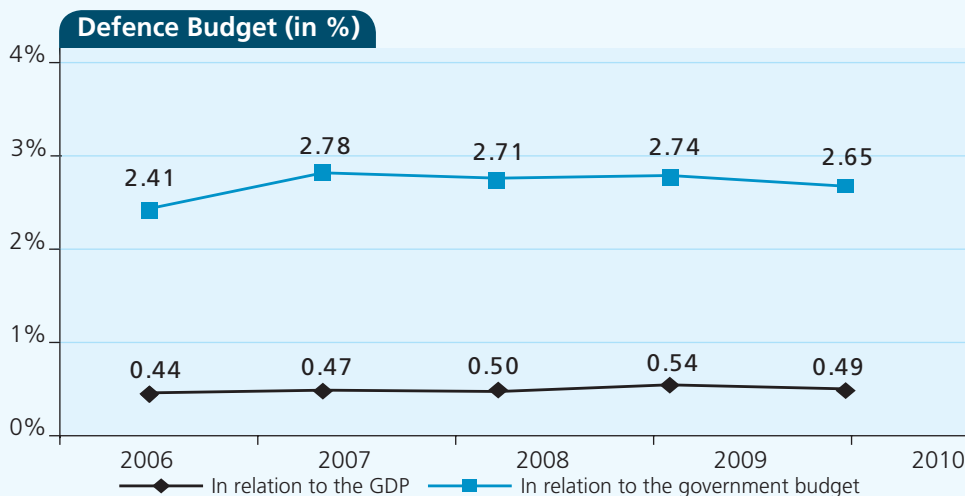

## Defence Budget Breakdown

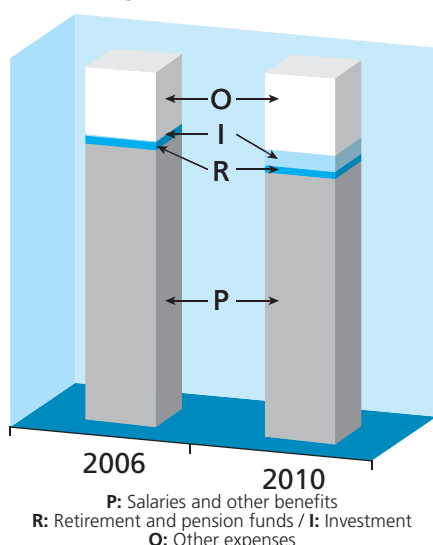

## Comparative Increase (% variation 2006-2010)

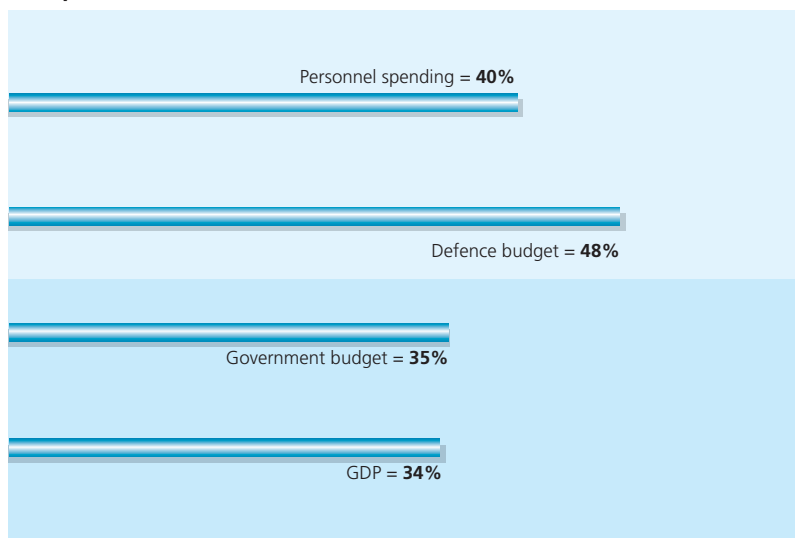

## Defence Budget 2010 (in Local Currency)

Branches*	Personnel Services	Materials and Supplies **	Other Expenses	Investment	TOTAL
<b>Secretary of Defence Programme</b>					
Command of the Mexican Air Force	2,177,667,354	871,147,705	0	1,439,000,000	4,487,815,059
National Defence Staff	3,327,254,269	440,401,082	0	0	3,767,655,351
Military Regional Commands	19,655,633,318	2,826,325,949	79,434,000	0	22,561,393,267
Military Industry General Directorate	468,979,011	306,696,193	0	0	775,675,204
General Audit of the Military Justice	186,704,345	13,660,393	0	0	200,364,738
Presidency of the Military Supreme Military Tribunal	103,853,204	3,812,208	0	0	107,665,412
Army and Air Force College General Directorate Military Education and President's Office	1,054,356,942	101,968,736	243,696,000	0	1,400,021,678
General Directorate of Health	3,057,983,857	1,160,660,817	0	0	4,218,644,674
Other General Directorates***	4,984,982,339	1,128,187,589	0	5,000	6,113,174,928
<b>Navy Programme</b>					
Board of Admirals	14,107,653	273,750	0	0	14,381,403
Naval Board	9,020,969	175,200	0	0	9,196,169
Navy General Staff	368,146,274	33,135,000	0	172,300,000	573,581,274
Naval Forces, Regions, Zones and Sectors	8,299,851,245	662,093,215	0	0	8,961,944,460
General Directorate of Naval Constructions	183,238,622	125,444,400	0	404,895,091	713,578,113
General Directorate of Investments and Development	169,262,093	77,378,000	5,550,000	0	252,190,093
Other General Directorates****	2,529,363,116	1,916,137,410	86,341,600	642,304,909	5,174,147,035
Secretary*****	232,490,546	60,360,100	0	0	292,850,646
<b>Institute of Social Security (ISSFAM)</b>	233,505,470	2,307,341,224	1,257,562,000	743,558,040	4,541,966,734
<b>TOTAL</b>	<b>47,056,400,627</b>	<b>12,035,198,971</b>	<b>1,672,583,600</b>	<b>3,402,063,040</b>	<b>64,166,246,238</b>

\* Responsible units.

\*\* It includes 10,189,746 Pesos for allowances granted by the ISSFAM.

\*\*\* Administration, Factories of Outfits and Equipment, Engineers, Social Communication, Human Rights and Information Technology.

\*\*\*\* Administration and Finance, Services and Human Resources.

\*\*\*\*\* Includes responsible units of Under-Secretary, General Administration, Juridical Unit, General Inspection and Control.

The main contracts entered into for military acquisitions in 2010 are broken down as follows:  
 - Secretary of Defence: US\$ 260,675,300  
 - Secretary of the Navy: US\$ 65,200,000  
 Said amounts represent 6.7% of the budget allocated to defence.

**Source:** Compilation based on *Ley de presupuesto de egresos de la Federación 2006, 2007, 2008, 2009 and 2010*. The State Budget passed by the Congress by means of the above mentioned Act is considered herein. The concept of investment is that expressed in "Investment". Acquisitions: *Cuarto Informe de Labores de la Secretaría de la Defensa Nacional, 2010* and *Informe de Finanzas Públicas y Deuda Pública* Secretary of Economy and Public Safety. It includes the contracts with the companies EADS CASA, EUROCOPTER and International Air Electronics (Aero Electrónica Interacional). The amount expressed for the Secretary of the Navy corresponds to the loan secured to refinance debts arising from the acquisition of 5 C-295 airplanes and 2 CN-235 airplanes. Information as of August 3rd, 2010.

GDP: Projection of the World Economic Outlook Database, IMF, of each year under review. This source has been taken for comparative purposes. Each country prepares the budget based on its own GDP estimation. The dollar value considered corresponds to the exchange rate determined by the World Economic Outlook Database, IMF, for each year under consideration. As of July, the 2010 exchange rate average is 12.69 Pesos, based on the data provided by the Central Bank of Mexico. For further calculations, figures are provided in local currency.

Expressions in Bold Type (Table) make reference to the various defence budget items, which can be found in a sector-based or institutional classification of the Budget Act.

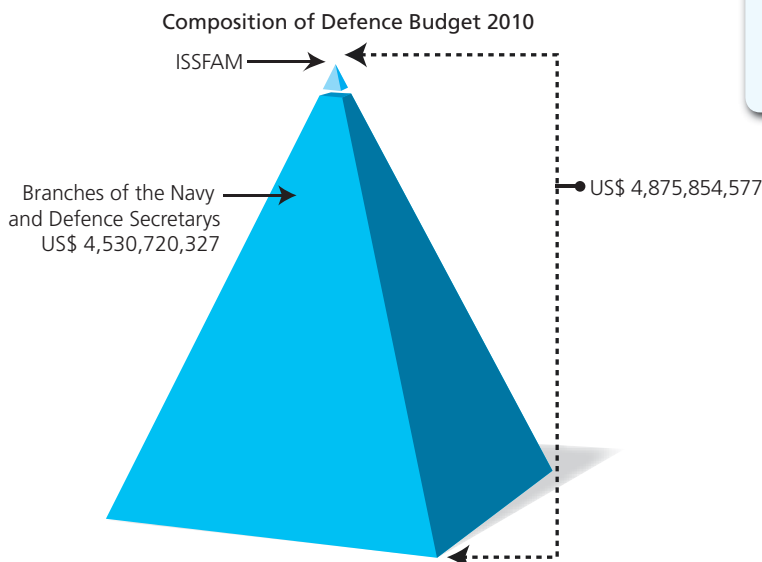



**The Secretary of National Defence**

**Responsibility:**

The Secretary of National Defence exercises the High Command of the Army and the Air Force; is responsible for organizing, equipping, educating, training, instructing and managing the Ground and Air Forces, in conformity with the instructions issued by the President of the Republic. (Ley orgánica del Ejército y la Fuerza Aérea, DOF 1986/12/26. Last amendment: DOF 2009/06/12, Sec. 16 and 17)

**Organization Chart**

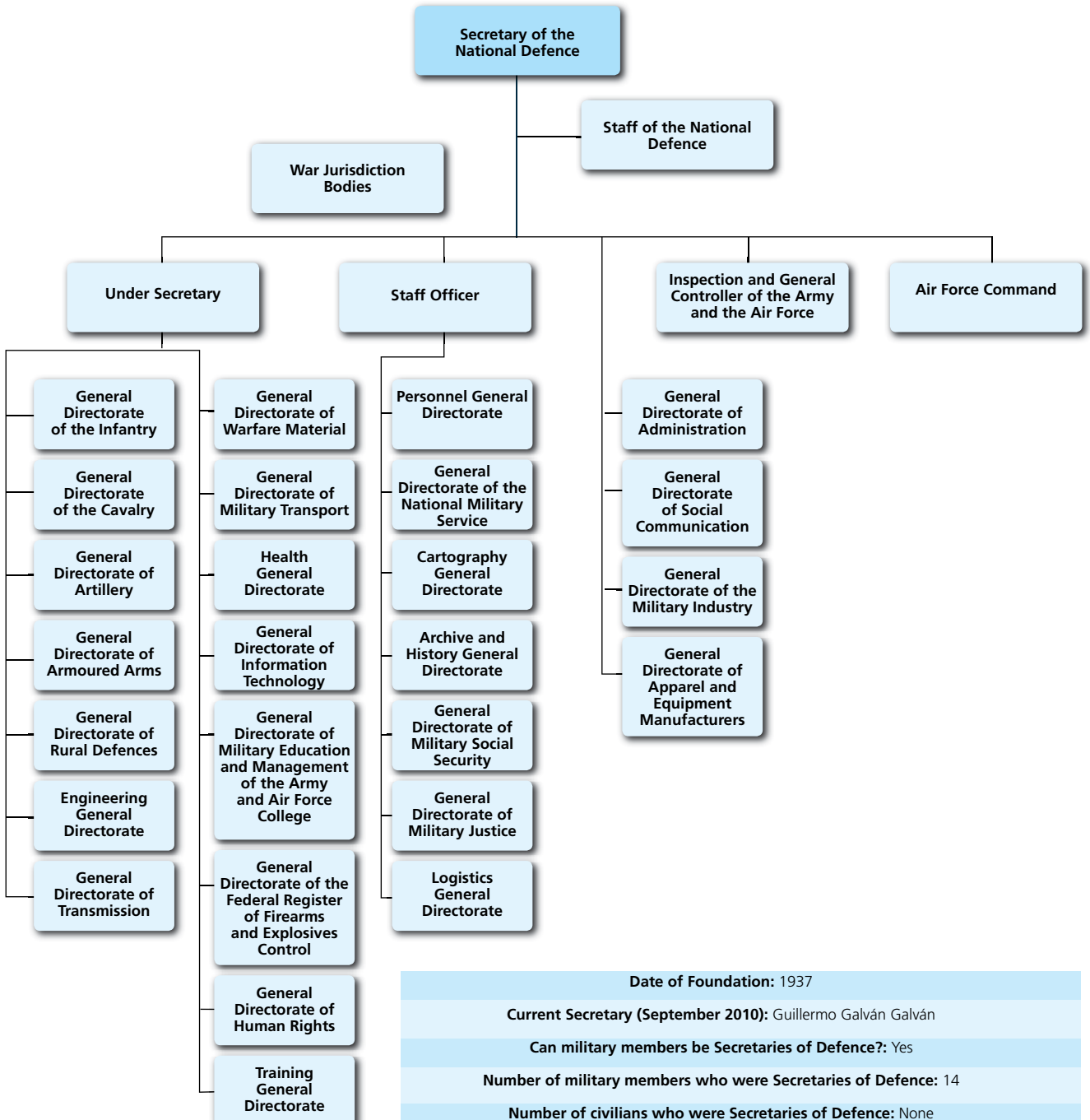

<b>Date of Foundation:</b> 1937
<b>Current Secretary (September 2010):</b> Guillermo Galván Galván
<b>Can military members be Secretaries of Defence?:</b> Yes
<b>Number of military members who were Secretaries of Defence:</b> 14
<b>Number of civilians who were Secretaries of Defence:</b> None
<b>Have there been any women in charge of the Secretary of Defence?:</b> No
<b>Average permanence in the Secretary of Defence position:</b> 4 years and 11 months

Source: Compilation based on the information provided by the Secretary of National Defence.

**The Secretary of The Navy**

The Secretary of the Navy exercises the high commands of the Mexican Navy (*Ley orgánica de la Armada de México*, DOF 2002/12/30. Last amendment: DOF 2009/06/12, sec. 7)

**Organisation Chart**

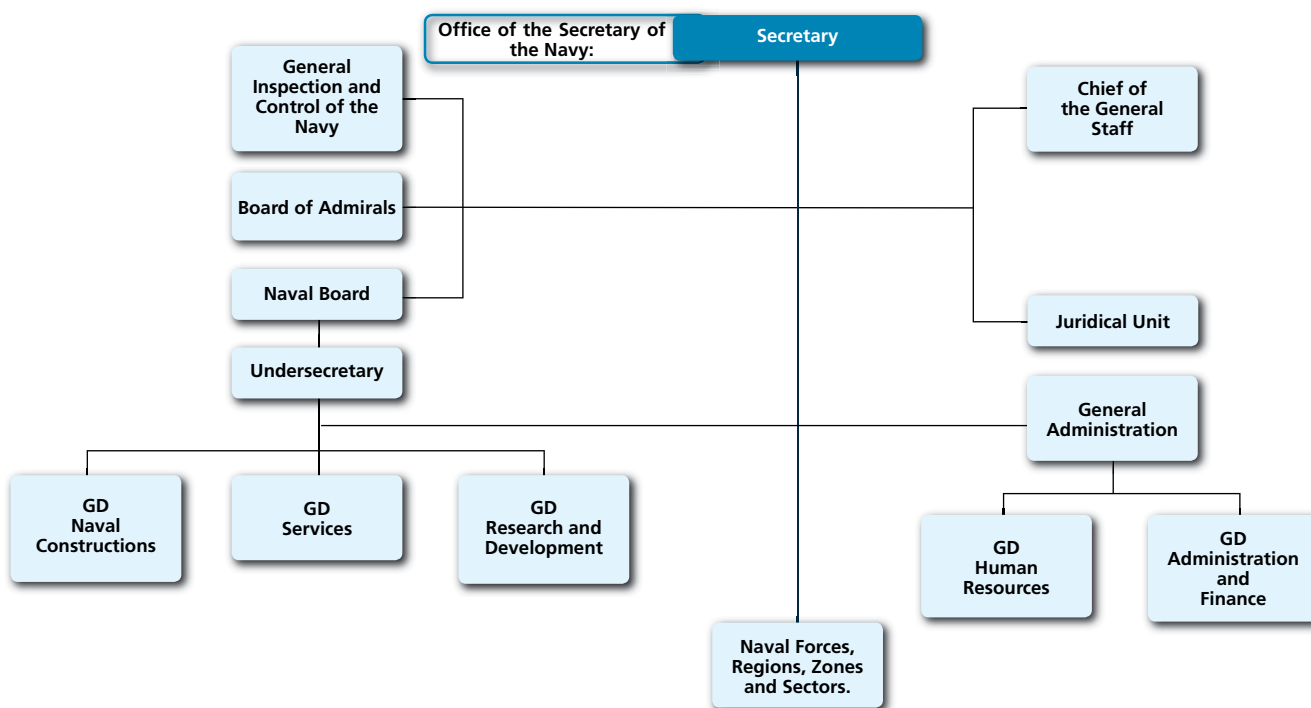

<b>Date of Foundation:</b> 1940
<b>Current Secretary (September 2010):</b> Francisco Saynez Mendoza
<b>Can military members be Secretaries of the Navy?:</b> Yes
<b>Number of military members who were Secretaries of the Navy:</b> 15
<b>Number of civilians who were Secretaries:</b> 3
<b>Have there been any women in charge of the Secretary?:</b> No
<b>Average permanence in the Secretary position:</b> 3 years and 8 months

Source: Compilation based on the information provided by the Secretary of the Navy.

**Meetings among Staffs of the National Defence, the Air Force and the General Staff of the Navy**

2008	2009	2010
3 meetings	4 meetings	3 meetings

**Interoperational Capacity**

For the purpose of ensuring national security and taking into account the limiting strategic factor that the separation of the military component into two State Secretaries represents; an increase in cooperation and coordination mechanisms related to interests common to the Secretary of National Defence and the Secretary of the Navy were taken into consideration.

**Army and Air Force personnel who attended courses at naval facilities**

2008		2009		2010	
13 Courses	Officers 18	9 Courses	Officers 11	12 Courses	Officers 17
	Troops 8		Troops 46		Troops 22

**Naval Personnel who attended courses at Army and Air Force facilities**

2008		2009		2010	
7 Courses	Officers 18	38 Courses	Officers 61	33 Courses	Officers 32
	Troops 15		Troops 48		Troops 137

Source: *Tercer Informe de Labores*, Secretary of National Defence, 2009; *Cuarto Informe de Labores*, Secretary of National Defence, 2010; *Tercer Informe de Labores*, Secretary of the Navy, 2009.



Political Definitions

Policy Guidelines

Sector Plans

National Lines of Development. Main Objectives related to the Armed Forces

Rule of Law and Security

Defence of the national sovereignty and territorial integrity:  
 - Guarantee national security and preserve the physical integrity and heritage of the Mexican people over any other interest.  
 - Ensuring the country's national integrity is fundamental for Mexico's progress. The country's borders, waters and coastlines must not serve as a route for crime. The geological makeup of the land and climate conditions of the different regions, as well as natural phenomena such as earthquakes, storms, cyclones, floods, and forest fires pose a permanent risk to the safety of the people.

Strategies:  
 - Strengthen the Armed Forces' capabilities by the updating, training, and modernization of their equipment, so as to ensure the effective protection of the national territory and waters, land and maritime borders, natural resources, airspace and strategic facilities.  
 - Within the framework of the National Civil Protection System, strengthen coordination of the Armed Forces and state and municipal governments in the development, execution and conduct of the corresponding emergency plans.

Border Security:

- Safeguard border security, as well as the integrity and respect for human rights of both its inhabitants and immigrants: focusing on the reorganization of the borders so that these regions can become more thriving and safer places. Borders must be the gateways to development, not to crime.

Strategies:  
 - Establish combined police units integrated by the Federal Prevention Police and border and state police to guarantee, with the support of the Armed Forces, the safety of the Mexican people and all border area inhabitants.  
 - Create channels for information and strategy exchange in areas of border security.

Organized Crime:

- Recover the strength of the State and security for the smooth cohabitation of the community, through a frontal and effective fight against drug trafficking and other forms of organized crime.

Objectives and Strategies. Office of the Secretary of Defence

- Focus primarily on human resources as the fundamental pillars of the institution:  
 - Improve living standards of military personnel and their beneficiaries, as well as motivate and strengthen their ethics and morale.  
 - Upgrade structures and administrative processes, ensuring the efficient use of available personnel.
- Improve operational efficiency of the Mexican Army and Air Force:  
 - Optimize structures and administrative processes, ensuring efficient use of materiel and financial resources.  
 - Modify military training, under the philosophical principle of "training for the test," by applying two instruments: task/s that are the object of execution-oriented training; and instruction/evaluation schemes, through which training missions (tactical exercises) are carried out.  
 - Consolidate military education, so that the cadre may be nurtured by professional military officers and strong military values and virtues.  
 - Strengthen logistics support to provide services and functions carried out for the benefit of units, sections and facilities.  
 - Update military doctrine and strengthen technological research and development.  
 - Consolidate interoperability, coordination and cooperation actions with the Secretary of the Navy.
- Ensure national defence and support Mexico's foreign policy.  
 - Promote policymaking and the application of a national defence policy that supports and ensures gradual development and integration of the armed apparatus.  
 - Contribute to guaranteeing the Federations' external defence against any opposition that may threaten national security.  
 - Strengthen national airspace surveillance coverage and capacity to respond to events affecting citizen security and the integrity of the national territory.  
 - Support actions aimed at protecting North and South borders.  
 - Optimize security of the country's strategic facilities, with the purpose of preserving the basic structure for national development.  
 - Support Mexico's projection in the international arena to contribute to national efforts in terms of security and the defence of sovereignty.  
 - Strengthen bilateral relations, at the Secretarial level, with military forces of other nations.  
 - Contribute to actions taken by the Government of the Republic to support countries exposed to natural disasters or human-caused catastrophes.
- Support homeland security policies, within a framework of respect for the rule of law.  
 - Improve operational schemes in the comprehensive fight against drug trafficking.  
 - Contribute to activities performed by law enforcement agencies.  
 - Cooperate for the maintenance of the Rule of Law by limiting the actions of armed groups across the national territory.  
 - Strengthen capacities for the implementation of the Federal Law of Firearms and Explosives.
- Carry out social actions to strengthen and contribute to the country's growth

- and support people's living conditions.  
 - Strengthen the national identity as an essential value for the integral development of the Mexican State.
- Contribute to building social welfare conditions in the most vulnerable areas of the country.
- Actively participate in environmental protection programs.
- Strengthen capacities for the elaboration, execution and conduct of the Defence against Natural Disasters Plan (Plan DN-III-E).
- 6. Promote civil-military relations within a democratic and transparent structure, under a system of accountability.  
 - Promote greater closeness between the Powers of the Union and the people in general.  
 - Promote measures aimed at improving management, and contribute to an efficient, effective and transparent performance, and the strengthening of the culture on human rights and international humanitarian law.  
 - Establish a social communication policy to reflect an image of the Mexican Army and Air Force that is in line with the activities performed.

Objectives and Strategies. Office of the Secretary of the Navy

- Protect national maritime interests.  
 - Strengthen the operational capacity of the Federation's Naval Power to help ensure national security and peace, and defend the country's sovereignty and integrity to guarantee the viability of both State and democracy.  
 - Optimize naval operation development to improve maritime security.
- Apply Rule of Law in national waters and coastlines.  
 - Guarantee security and control of Mexico's seas and coastlines, so as to enforce constitutional order and prevent the use of these routes in drug trafficking and organized crime activities.  
 - Develop and acquire the necessary technology, equipment and systems to improve intelligence collection against drug trafficking, organized crime and terrorism.
- Ensure the physical safety of people in the seas and coasts of Mexico.  
 - Increase the resources, mechanisms, and professionalism of naval personnel, so as to effectively protect human life at sea and help population in the event and at the place of disaster.
- Contribute to Mexico's sustainable maritime development.  
 - Create synergies with stakeholders and entities with concerns in the maritime scenario, so as to contribute to navigation safety and shipping development.  
 - Contribute to the protection of ecosystems in the marine environment, which allow sustainable development of socio-economic projects.
- Improve people's trust towards the Secretary.  
 - Increase professionalism, physical, mental and moral conditions of naval personnel towards the efficient performance of navy operations in benefit of the service this institution provides for the Nation.  
 - Promote and disseminate knowledge of citizens as regards activities performed by the Mexican Navy (SEMAR), so as to strengthen people's trust in the institution.

Source: Plan Nacional de Desarrollo 2007-2012, Programa Sectorial de la Defensa Nacional 2007-2012 (Secretary of National Defence) and Programa Sectorial de Marina 2007-2012 (Secretary of the Navy).

Mexico published the Libro del Ejército y Fuerza Aérea Mexicanos (Mexican Army and Air Force Book) in 2005.

1997	1998	1999	2000	2001	2002	2003	2004	2005	2006	2007	2008	2009
✘	✘	✘	✘	✘	✘	✘	✘	✘	✘	✘	✘	✘
◆		◆	◆	◆	◆	◆	◆	◆	◆	◆	◆	◆
	★			★	★	★				★	★	★

Register of Conventional Arms: ✘ Register of Military Expenditures: ◆ Implementation of Confidence and Security Building Measures: ★

Source: Compilation based on reports submitted to the United Nations Register of Conventional Arms and the United Nations Instrument for Reporting Military Expenditures and reports submitted to the OAS on the Implementation of Confidence and Security-Building Measures.

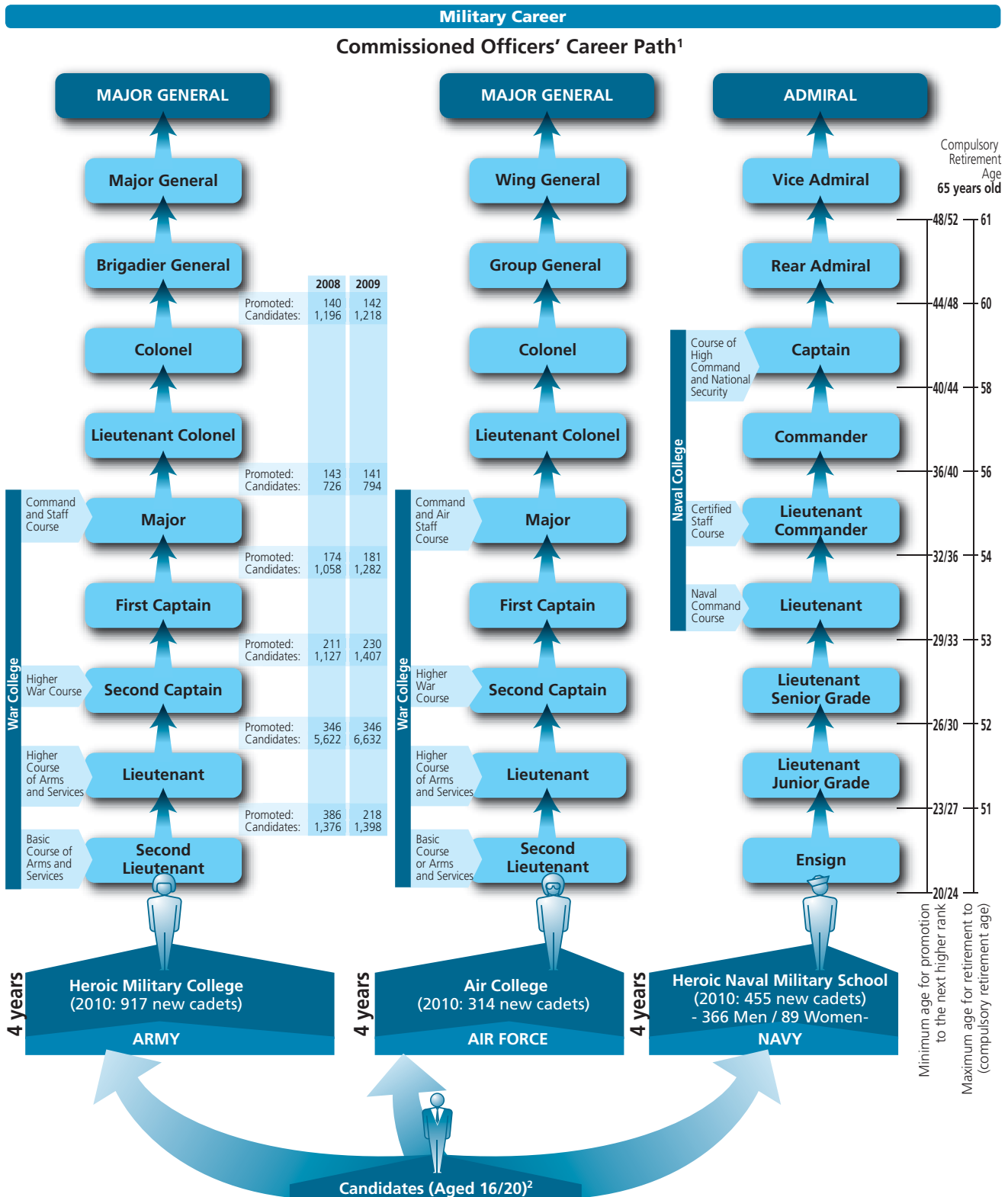

<sup>1</sup> Command corps includes officers who have been educated at military academies from the beginning of their professional careers. The graph makes a theoretical reconstruction of officers' promotion through the completion of mandatory courses. Further requirements for promotion have not been considered. In the case of the Army and the Air Force, the number of officers that applied and got promoted to the next higher rank in 2008 and 2009 is shown.

<sup>2</sup> Ages 16-20 years have been considered for comparative purposes. Entry age varies depending on the service: Army 16-20 years old, Naval Force 15-18 years old, Air Force 16-20 years of age. The minimum age for promotion will depend on the age of graduation from the military education institution

**Source:** Compilation based on *Ley de ascensos de la Armada de México* (DOF 2004/06/25. Last amendment: DOF 2010/08/27), *Ley orgánica de la Armada de México* (DOF 2002/12/30. Last amendment: DOF 2009/06/12), *Ley de ascensos y recompensas del Ejército y Fuerza Aérea* (DOF 2003/10/30. Last amendment: DOF 2009/06/12), *Ley orgánica del Ejército y la Fuerza Aérea* (DOF 1986/12/26. Last amendment : DOF 2009/06/12), *Ley del instituto de seguridad social para las Fuerzas Armadas* (DOF 2003/07/09. Last amendment: DOF 2008/11/20). New cadets: Information provided by the Secretary of National Defence and the Secretary of the Navy.





## The Armed Forces

### General Mission

Defend the integrity, independence and sovereignty of the Nation, guarantee internal security and external defence. Help civilian citizens in cases of public necessity; carry out civic and social work aimed at the country's progress and in case of disaster, aid in keeping public order, assistance to the people and their assets as well as with reconstruction of affected areas. Make use of the Federation's naval power for external defence, and render assistance for the country's internal security. (Ley Orgánica del Ejército y Fuerza Aérea Mexicanos, DOF 1986/12/26, Sec. 1 and Ley Orgánica de la Armada de México, DOF 2002/12/30, Sec. 1)

### Specific Missions

#### Navy

- Defend the integrity, independence and sovereignty of the Nation.
- Use the naval power of the Federation for providing external defence and contributing to the internal security of the country.

#### Army

- Defend the integrity, independence and sovereignty of the Nation.
- Guarantee internal security.
- Provide assistance to civilians in case of public need.
- Carry out civic actions and social work to support the growth of the country.
- In case of disaster, provide assistance to maintain the order, help people and their assets and rebuild affected areas.

#### Air Force

- Defend the integrity, independence and sovereignty of the Nation.
- Guarantee internal security.
- Provide assistance to civilians in cases of public necessity.
- Carry out civic actions and social work to support the growth of the country.
- In cases of disaster, provide assistance to maintain the order, aid the people and their assets and rebuild affected areas.

**Total Strength: 258,439**

	<b>Officers:</b>	
<b>M</b> 10,391	<b>W</b> 2,416	
<b>Classes:</b>		
<b>M</b> 22,174	<b>W</b> 4,059	
<b>Crews:</b>		
<b>M</b> 12,152	<b>W</b> 1,234	
<b>M</b> 85.30%	<b>W</b> 14.70%	
<b>Total: 52,426</b>		

	<b>Officers:</b>	
<b>M</b> 34,231	<b>W</b> 3,217	
<b>Non-commissioned Officers and Troops:</b>		
<b>M</b> 161,548	<b>W</b> 7,017	
<b>M</b> 95.03%	<b>W</b> 4.97%	
<b>Total: 206,013</b>		

**Army: 198,311**  
**Air Force: 7,702**

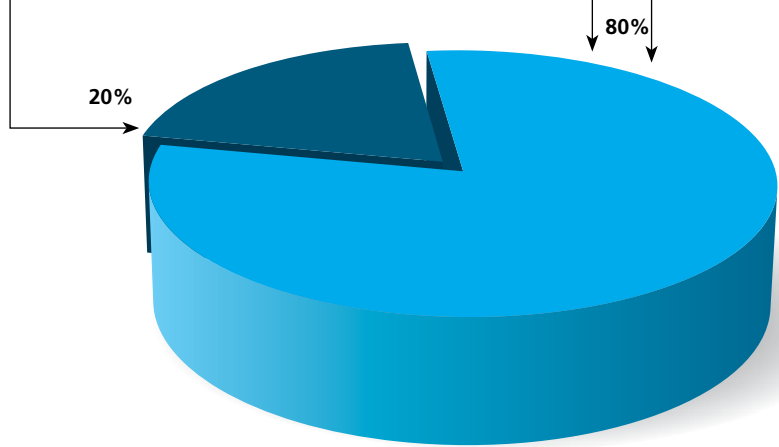

M: Men / W: Women

Source: Ley orgánica del Ejército y la Fuerza Aérea (DOF 1986/12/26. Last amendment: DOF 2009/06/12) and Ley orgánica de la Armada de México (DOF 2002/12/30, Last amendment: DOF 12/06/2009) (missions) and information provided by Secretary of National Defence and Secretary of the Navy (regular force).

### Women in the Armed Forces

#### Women's Admission to the Armed Forces (year)

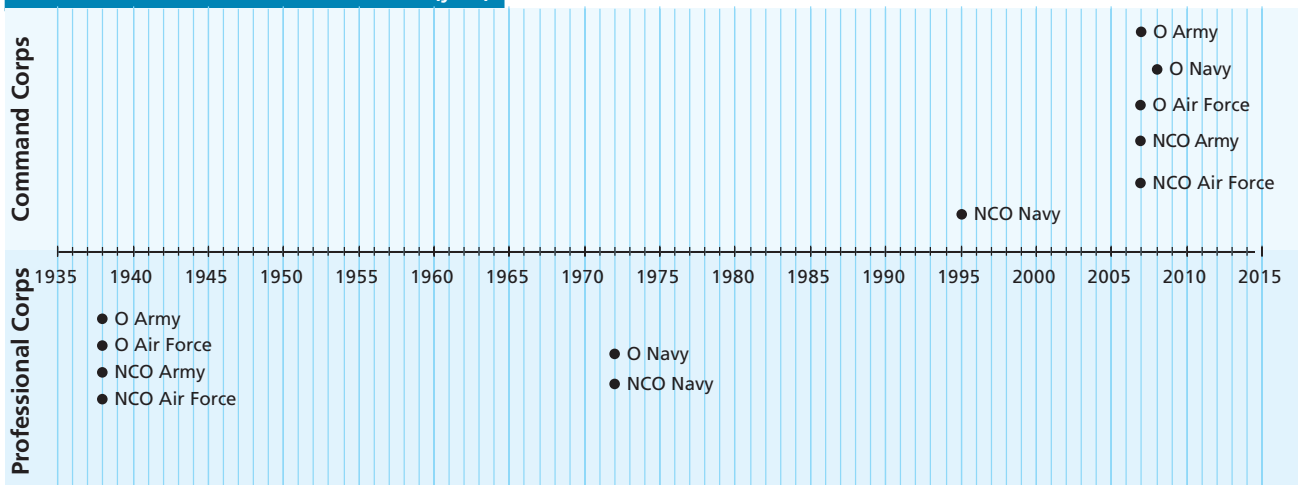

O: Officers - NCO: Non-commissioned Officers

**Note:** The Command corps includes officers who have been educated at military academies from the beginning of their professional careers. The Professional corps refers to those who develop a career in the civilian sphere and are then incorporated to the armed forces.

#### Women Officers who have reached the highest rank in the Command Corps (2010)

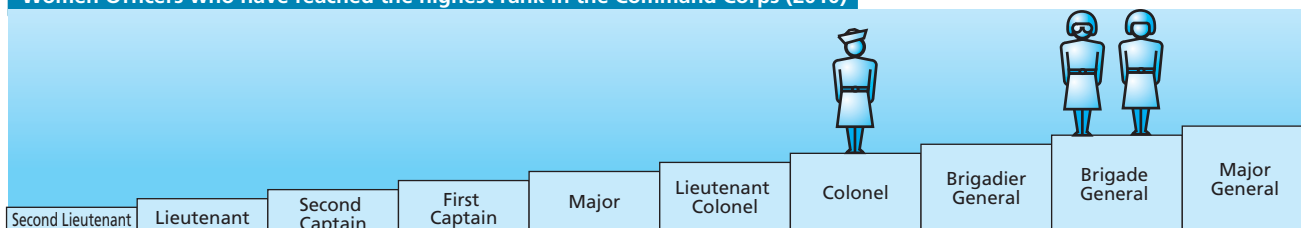

**Note:** These ranks correspond to the Army, as an example. The equivalent rank for Lieutenant Colonel is Commander (Navy) and for Brigade General is Wing General (Air Force). Women within the command corps of the three forces are under the instruction period. The highest ranks refer to female officers of the professional corps

6.94% (17,943) of the total Armed Forces are women.

**Source:** Information provided by the Secretary of National Defence and the Secretary of the Navy and Project 07-184 Global Peace and Security Fund – Resdal.

### Military Service

In Mexico, there are 2 alternatives for recruitment: the voluntary and conscription system (National Military Service).

The voluntary modality consists in recruiting personnel who spontaneously want to join the Military Service. The duration of the voluntary contracts is determined and shall never exceed three years in the arms or services, or five years in the assistant class.

- The National Military Service (SMN) is compulsory for all male citizens and lasts one year. Women can voluntarily participate. There are two modalities:

- **enrolled personnel:** they attend Saturday training sessions without receiving any monetary compensation;

- **stand by personnel:** they do not carry out Saturday training activities, they are just registered for the authorities' knowledge and control.

In the SMN framework, 4,558 women voluntarily took part in the Military Training Programme from September 2008 and August 2009.

Number of candidates that joined the voluntary military service. Army and Air Force	
2009	Total: 13,359
2010	Total: 8,499

SEDENA - SMN	
2009	
Recruited Personnel	
Enrolled	Stand by
63,980	363,262
2010	
Recruited Personnel	
Enrolled	Stand by
62,959	374,347

SEMAR – SMN		2009			
Location	Annual Vacant (Men)	Beginners		Graduates	
		Women	Men	Women	Men
Baja California	250	0	111	0	56
Baja California Sur	430	0	219	0	162
Campeche	550	1	423	1	284
Chiapas	300	0	157	0	102
Colima	400	0	224	0	157
Guerrero	300	0	200	0	130
Jalisco	200	0	121	0	68
México, D.F.	1,000	0	811	0	539
Michoacán	350	0	84	0	66
Oaxaca	300	0	163	0	120
Quintana Roo	300	0	129	0	98
Sinaloa	250	0	227	0	150
Sonora	200	1	94	1	34
Tamaulipas	1,200	1	883	1	432
Veracruz	1,100	8	733	8	442
Yucatán	250	0	194	0	94
TOTAL	7,380	11	4,773	11	2,934

**Source:** Information provided by the Secretary of the Navy and the Secretary of National Defence.



**Defence and National and International Community**

**Drug Trafficking and Organized Crime**

Drug trafficking and organized crime events are considered to be threats to the internal order that exceed the response capacity of Public Security Forces. For that reason, the Secretaries play an active role in the national public security system, cooperating with the three government level authorities. The regulatory framework supporting the Integral Fight against Drug Trafficking and Organized Crime is comprised within the 2007-2012 National Plan of Development, the Integral Strategy against Drug Trafficking of the Mexican State and Sector-based Programmes of the National Defence and the Navy, where guidance is established to strengthen cooperation and coordination at a national level.

**Secretariat of the Navy, Operation Inflexible**

Counter-narcotics operations to fight illicit drug trafficking in Mexican maritime areas, through the implementation of actions to combat drug-trafficking and organized crime in the most vulnerable regions with a higher incidence of illegal activities.

Counter-Narcotics Operations (September 2008 - July 2009)	
11,950 operations	
8,118 naval elements (average monthly involvement)	
39,699,006 marihuana plants eradicated	
2,873,481 poppy plants eradicated	
Securing of 30,432,904 kilograms of marihuana	
Securing of 21,795.618 kilograms of cocaine	
Seizures: 29 hand arms, 46 long arms, 21 vessels, 49 ground vehicles	

**Decentralization Programme (SEDENA)**

As per the 2007-2012 Guidance for the Integral Fight against Drug Trafficking (*Directiva para el Combate Integral al Narcotráfico*), the High Command has granted the commanders of each military region the power to implement and conduct high impact regional operations. Following this concept, commanders of each jurisdiction are free to use the resources made available for that purpose; this condition has allowed the timely deployment of troops in critical areas and points.

Destructions September 2008 - August 2010 (SEDENA)					
Concept	Hectares		Unprocessed Marijuana (Kg)	Seed (Kg.)	
	Marijuana	Poppy		Marijuana	Poppy
High impact	21,219	22,709	1,650,148	13,077	3,864
Regional	1,078	776	57,152	1,291	64
Occasional actions	10,991	6,346	656,204	15,583	1,712
<b>Total</b>	<b>33,288</b>	<b>29,831</b>	<b>2,363,504</b>	<b>29,951</b>	<b>5,640</b>

Operations Against Organized Crime (SEMAL)	
2008	January – June 2009
13,705	16,757

Joint Operations	
September 2008 - July 2009	
Operations	17,148
Monthly troops (average)	3,642

**Combined Operation Bases**

Combined Operation Bases are inter-institutional forces which carry out mobile or stationary surveillance operations with the aim of fighting crime in high risk areas which present a significantly high level of public insecurity.

Said bases consist of troops from the jurisdictional operating units of the military zones, agents from the Federal Public and Common Ministry, manpower from the Ministerial Federal Police, ministerial police personnel, and preventive state agents, with their respective vehicles. As of 2010, 944 Combined Operation Bases were implemented with 21,939 military troops and 6,765 civilians, supported by 2,129 military vehicles.

Source: Information provided by the Secretary of National Defence and the Secretary of Navy, *Tercer Informe de Labores*, Secretary of National Defence, 2009; *Cuarto Informe de Labores*, Secretary of National Defence, 2010; *Tercer Informe de Labores*, Secretary of Navy, 2009.

### Protection of Strategic Facilities.

SEMAR September 2008 - August 2009	
Patrolling	25,057
Elements deployed	1,120

SEDENA September 2009 - August 2010	
Patrolling	12,512
Elements deployed	126,543

### Support Activities

The 2007-2012 National Plan of Development sets out, within the framework of the national civil protection system, the reinforcement of the cooperation among the Armed Forces, the State Governments and the Municipalities to elaborate, execute and conduct aid plans.

The Support Force in Cases of Disaster is a body created for the purpose of increasing the response capacity of operation units. It makes available a force capable of acting in any area of the national territory, before, during or after a catastrophic event.

Activities are conducted to cope with winter conditions, forestall and urban fires, tropical systems, floods, heavy rains, seismic activity, chemical leaks and explosions.

#### DN-II-E Aid Plan for Civil Population, Secretary of the National Defence (SEDENA)

During the Plan, in 2009, aid was provided to the population involved in the disasters caused by 3 hurricanes, 274 forestall fires, and low temperatures during winter season. Medical care, food supply and debris removal activities were carried out, jointly with evacuation operations.

DN-III-E	Troops	Evacuated Persons	Patients
Hurricanes (Andrés, Jimena, Rick)	4,190	7,450	164,566
Winter season	518	-	-
Fires (274)	10,199	-	-
TOTAL	14,907	7,450	164,566

#### Navy Plan (Plan Marina), Secretary of the Navy (SEMAR)

The 2009 plan included a series of support activities for the community due to natural disasters related to hurricanes, floods and overflows. The assistance consisted in the delivery of 70,671 luncheons and food rations, 1,015,525 litres of water, 14,371 basic items such as mats and cleaning equipment, 777 patients were taken care of and roads and access pathways were put back in service.

Navy Plan (Plan Marina)	Troops	Evacuated Persons	Assisted Communities
Hurricanes (Jimena, IDA, Rick)	2,322	4,908	78
Overflows	58	61	7
Floods	351	3,700	103
TOTAL	2,731	8,669	188

### External Radiological Emergency Plan (PERE)

The purpose of this plan is to provide support to the civil population, in cooperation and coordination with other departments of the External Radiological Emergency Programme Committee (COOPERE), in the event of an emergency at Laguna Verde Nuclear Electric Plant, located in Alto Lencero.

### Social Work

The Social Work activities are developed in coordination with federal, state and municipal entities with the aim of supporting the isolated or underprivileged civil population living in rural areas or marginal suburbs or, which due to their location, has no access to basic services.

Support provided (SEDENA)	
September 2008 - August 2010	
Military personnel	4,278
Biological supplied	130,191

Social Work (SEMAR)	
September 2008 - August 2009	
Beneficiaries	3,544
Biological supplied	42,450

#### Humanitarian Aid in Haiti

From January 14th to May 15th, 2010, a Mexico-Haiti/Haiti-Mexico air bridge was implemented as part of the operations carried out by the Federal Government of Mexico to provide support to the Republic of Haiti. Shipments included 259 military personnel of the Humanitarian Aid Service Group, 530 civilians, 787,200 warm food portions, 146,200 luncheons, 497 patients checked, 114 medical treatments and 82,700 litres of water. Likewise, donations amounted to 411 campaign tents, 42 camp beds, cooking elements, and one communal kitchen with spares and utensils.

#### International Humanitarian Aid

From October 15th to 30th, 2008, 87.2 tons of food, medicines and support equipment were sent to the Republic of Cuba and the Republic of Haiti, as part of the support provided by the Mexican Federal Government.

- In La Habana, Cuba, 40.2 tons of food were delivered.
- In Port-au-Prince, Haiti, 30 tons of food and 6.3 tons of medicines were delivered.

Source: *Tercer Informe de Labores*, Secretary of National Defence, 2009; *Cuarto Informe de Labores*, Secretary of National Defence, 2010; *Tercer Informe de Labores*, Secretary of the Navy, 2009.



## Analisis:

# “War” on Drugs

**Jesús Aranda Terrones**

*La Jornada, Mexico*

A few days after taking office in Mexico in December 2006, President Felipe Calderon declared “war” to drug trafficking. Knowing that the agencies constitutionally in charge of fighting this crime -the Republic’s General Attorney (PGR) and the Federal Secretariat for Public Security (SSP) - lacked any operational, material or human capability to counter a challenge of this magnitude, Calderon resorted to the “last line” the Mexican State has to face external threats and ensure internal security: the armed forces.

But then again, neither the Army nor the Navy of Mexico was prepared to take up this mission. The announcement was made by Calderon in his capacity as the Supreme Commander of the Armed Forces, and high army and navy ranks found themselves obligated to prepare at forced march to attain the one objective that became their main endeavor: fight against drug trafficking and organized crime.

Soldiers shifted from the first priority activity they had since the sixties of the past century, to the destruction of marijuana and poppy plantations and the implementation of “high profile” raids in cities including Michoacán, Baja California, Chihuahua, Tamaulipas y Sinaloa --initially-- where various soldier units (counting up to over five thousand soldiers in some places) performed public security duties, patrolled streets, established check points and conducted intelligence tasks to seize drug cargoes and drug traffickers.

Before this administration, some 20,000 soldiers used to take part in daily operations aimed at destroying illicit plantations. Participation in high profile raids required 50,000 troops on a daily basis and, in 2010, the total number of soldiers reached 97,000. These figures mean that almost half of the Mexican military is now involved in the fight against drug traffic.

In the case of the Department of the Navy, the number is not so high; only 20% of the Navy’s 50,000 men participate in operations against organized crime. The task of these officers in this fight, however, has diversified over the last six years. Now, they are entrusted with preventing drug entry from the sea; they have a leading role in the inspection of ships arriving at Mexican ports, seizing dozens of tons of cocaine coming from South America on cargo container ships; and they destroy drug plantations grown in territories more and more removed from coastal lands. They are also involved in so-called “surgical operations” --so dubbed by Admiral Secretary Mariano Francisco Saynez Mendoza-- devised to deter drug dealers, seize weapons and drugs. The death of the “lord of lords” --one of Mexico’s leading drug dealers-- occurred in December 2009 after an action by the Navy’s elite corps, positioned navy officers in the line of combat against organized crime.

Against this backdrop and forced by the circumstances, the armed forces, supported by legal theories approved by the National Supreme Court of Justice in 1996

which empowered the Army to perform law enforcement activities in aid of civilian authorities, took control over the crackdown on drug trade and went from being mere collaborators of the public ministry –as per constitutional mandate- to directly lead investigation and prosecution efforts against this crime. The Army, however, has paid a high price. Over the last few years, the desertion rate has reached 10% of the total strength; more than 100 military officers have been killed in anti-drug raids over the last three years; soldiers are increasingly worn out, both physically and morally, since most of them are away from home for periods exceeding three months destroying drug plantations or taking part in “high profile” operations -- a fact that has undermined the “esprit de corps” of many.

The Mexican Navy has been more conscious about this aspect, as proven by high rank orders to not keep soldiers away from their bases and families for longer than one month. Interestingly, however, this effort and commitment by the armed forces has also translated into growing reports of human right violations by soldiers and the ever increasing demand to have soldiers back to their quarters.

From December 2006 to June 2010, President Calderón’s administration, through the National Defence Secretariat (SEDENA) has received 3,430 complaints for alleged breach of individual warranties by the military, 51 of which have led to issuing discharge recommendations. In the period 2007-2009 the fight against drug traffic has led the Army to pay more than 8 million Mexican pesos (over US\$650,000) in compensations for the deaths of 24 innocent civilians –five of them under age- injuries, damages and medical services arising from raids conducted in different locations throughout the country. In addition, the number of innocent civilians killed by soldiers has raised irate demands from several social sectors and non-governmental organizations requiring the amendment of military court system, so that crimes committed by the military against civilians may be prosecuted in ordinary courts.

So far the criterion has been to consider that this type of crimes were committed “in the line of duty” and, therefore, should be prosecuted by military courts. The lack of transparency in the way soldiers stand trial, the vagueness surrounding investigations and the lack of information on criminal proceedings have led to disbelief in the military justice and favored an overall perception that crimes committed by soldiers go unpunished. Social organizations have advocated for legislation reform that clearly establishes that crimes perpetrated by the military against civilians are to be prosecuted in civilian courts. The federal admini-

stration has vowed to consider this issue, while the Government’s Secretariat has also pledged to raise it at the legislative sessions beginning September 2010.

High-rank Army officials have reportedly expressed their disagreement with this reform and insist on handling this issue as a military disciplinary problem that has to be dealt with by the military itself, adding that officers are subject to double trial --as they may be prosecuted for civil society and military crimes at the same time-- which speaks of their commitment to the rule of law and against impunity. They also note that making soldiers involved in anti-drug operations stand trial before civilian courts puts them at risk of retaliation. This argument stems from the murder, in December 2009 in the state of Tabasco, of the mother, two brothers and one aunt of Navy official Melquisedet Angulo Córdova, killed some days before during a raid were kingpin Arturo Beltrán Leyva was arrested. This action was a wake up call to the armed forces and both the Army and the Navy have tried as much as possible to avoid disclosing the names of soldiers who had been slain or wounded in anti-drug campaigns. This partly explains the Army’s reluctance, seeking to avoid “exposing” its ranks to criminal actions filed with ordinary courts.

On another note, despite the official message ensuring that there is full collaboration among the Secretariats under the Security Ministry, one fact cannot be denied. The most important arrests of alleged drug leaders, the largest drug seizures and the most successful operations in recent years have been carried out by Mexico’s Army and Navy. However, despite the commitment assumed and “due obedience”, time has clearly shown that involvement of the military in the offensive against organized crime has not turned out as expected by the federal government: violence is still rampant, drug cartels continue their dispute over markets and routes with the use of bloodbaths, abductions, mutilations, beheadings and other unprecedented signs of violence.

After three years of “war”, the Congress of the Union has formally requested President Calderón last May to “disclose an exact record of civilian deaths during the fight against drug trafficking”. According to an official report, 9,635 people were killed in organized crime-related clashes throughout the country in 2009, with the number of violent deaths estimated to have reached 24,000 between December 2006 and June 2010.

To date there is no indication that this figure will decline in 2010; quite the contrary, this trend is growing steadily.



# Nicaragua

## The Legal Framework and the Defence System

### National Legislation

#### Systems and Concepts

- Act on the Organization, Competence and Procedures of the Executive Power (N° 290 - 1998/06/03. Last amendment: Act N° 612 - 2007/01/29)

#### Military Organization

- Code of Organization, Jurisdiction and Military Social Benefits (Act N° 181 - 1994/08/23)  
 - Organic Act of Military Tribunals (N° 523 - 2005/04/05. Last amendment: Law N° 567 - 2005/11/25)  
 - Military Penal Code (Act N° 566 - 2006/01/05)  
 - Code of Military Penal Procedures (Act N° 617 - 2007/08/29)

— Advisory and assistance functional relationship  
 — Command reporting line

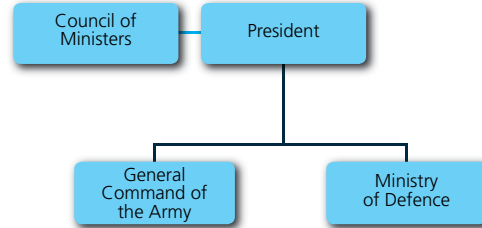

The President is the High Commander of the Army. The Minister of Defence directs the elaboration of policies and plans related to the defence of sovereignty, independence and territorial integrity. The Council of Ministers is composed of the President, the Vice President and the Ministers of State, with the functions granted by the Constitution. The Commander-in-Chief of the Army holds the General Command of the Army and is directly subordinate to the President. The High Command is composed of the Commander-in-Chief of the Army, the Chief of Staff and the Inspector General, and has the Military Council as consultative body. The General Staff is the technical, operational, administrative and service body and it assists the High Command. The Assembly holds the powers granted by the Constitution and permanently monitors defence related issues through the Peace, Defence, Government and Human Rights Committee.

**Source:** Compilation based on *Ley de organización, competencia y procedimientos del Poder Ejecutivo* (N° 290 - 1998/06/03. Last amendment: Act N° 612 - 2007/01/29).

**Source:** Compilation based on the legislation above mentioned. For constitutional provisions see Chapter 1.

## The Budget

Year	Defence Budget (in US\$)	Government Budget (in US\$)	GDP (in US\$)
2006	36,293,492	1,265,219,457	5,022,000,000
2007	39,336,274	1,351,284,846	5,675,000,000
2008	42,191,833	1,492,080,617	6,523,000,000
2009	37,293,776	1,598,952,131	6,298,000,000
2010	39,644,293	1,455,689,864	6,246,000,000

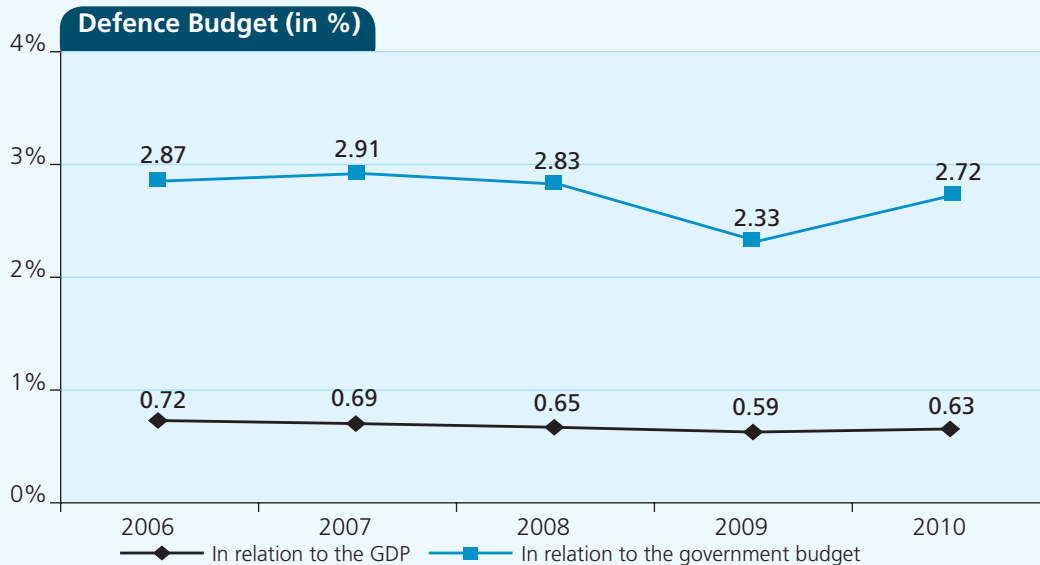

**Defence Budget Breakdown**

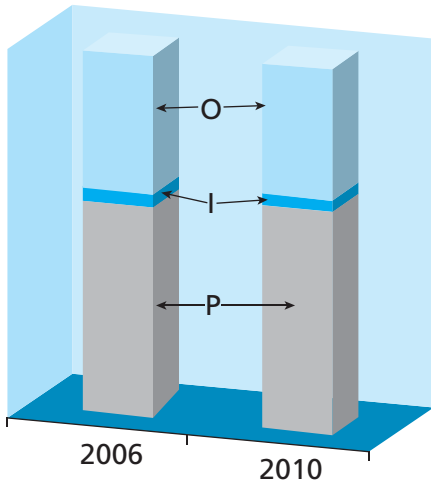

**P:** Salaries and other benefits  
**R:** Retirement and pension funds / **I:** Investment  
**O:** Other expenses

**Comparative Increase (% variation 2006-2010)**

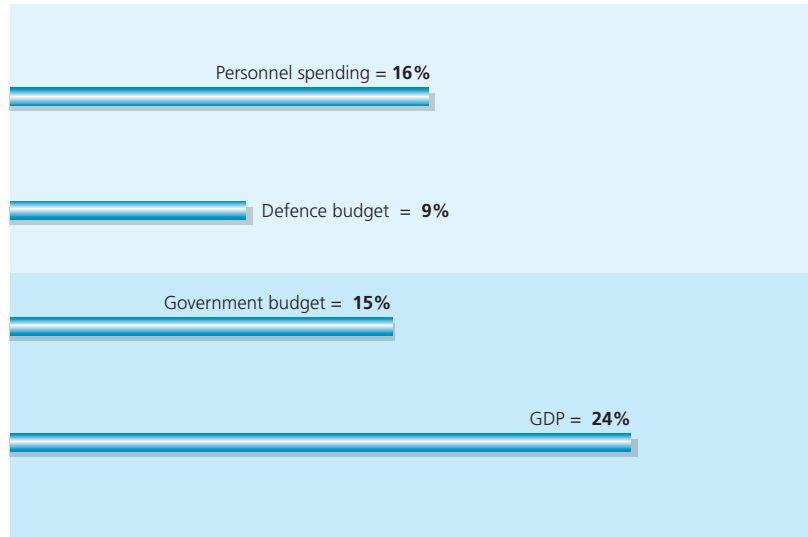

**Defence Budget 2010 (in Local Currency)**

Item	Personnel Services	Non-personnel services	Materials, Supplies and Consumer Goods	Current Transfers	TOTAL
<b>Ministry of Defence</b>					
Central Activities*	8,690,977	3,560,000	1,945,069	25,000	14,221,046
National Defence**	521,277,524	98,101,889	209,766,224	3,435,411	832,581,048
<b>Total</b>	<b>529,968,501</b>	<b>101,661,889</b>	<b>211,711,293</b>	<b>3,460,411</b>	<b>846,802,094</b>

\* This program is run by the Ministry of Defence, empowered by the President to head the creation of policies and plans regarding territorial sovereignty, independence and integrity defence of the Nation and, within these powers, coordinates and approves the plans and actions of the Army of Nicaragua.

\*\* This program is run by the Army of Nicaragua, institution in charge of preparing, organizing and directing the armed defence of the Nation, by defending territorial integrity, independence and national sovereignty.

**Composition of Defence Budget 2010**

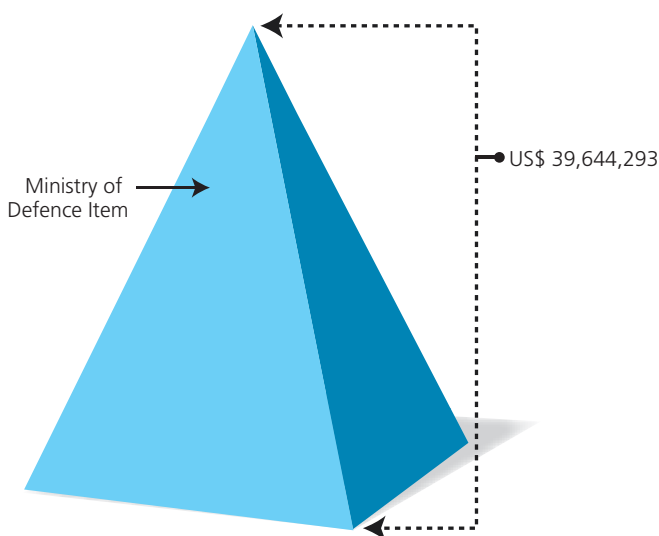

From 2007 to 2009, the contracts entered into with the United States for military acquisitions total US\$ 3,489,784, which represents 3% of the budget allocated to defence for those years. In addition, in 2009 the Army received military equipment donations from that country, in the framework of the *Amistad Duradera* programme.

**Source:** Compilation based on *Ley anual de presupuesto general de la República* 2006, 2007, 2008, 2009 and 2010. The State Budget passed by the Congress by means of the above mentioned Act is considered herein. The concept of investment is that expressed in "Capital expenses/Machinery and equipment". Acquisitions: *Memoria Anual* 2009, Army of Nicaragua and Just the Facts (Center for International Policy, Latin American Working Group Education Fund and Washington Office on Latin America).

GDP: Projection of the World Economic Outlook Database, IMF, of each year under review. This source has been taken for comparative purposes. Each country prepares the budget based on its own GDP estimation.

The dollar value considered corresponds to the exchange rate determined by the World Economic Outlook Database, IMF, for each year under consideration. As of July, the 2010 exchange rate average is 21.14 Córdobas, based on the data provided by the Central Bank of Nicaragua. For further calculations, figures are provided in local currency.

Expressions in Bold Type (Table) make reference to the various defence budget items, which can be found in a sector-based or institutional classification of the Budget Act.





**The Ministry of Defence**

**Responsibility:**

By delegation of the President of the Republic, the Ministry of Defence conducts the elaboration of policies and strategies for the defence of the sovereignty, independence and territorial integrity of the country.  
 (Ley de organización, competencia y procedimientos del Poder Ejecutivo, N° 612 – 2007/01/29, Sec. 3)

**Organization Chart**

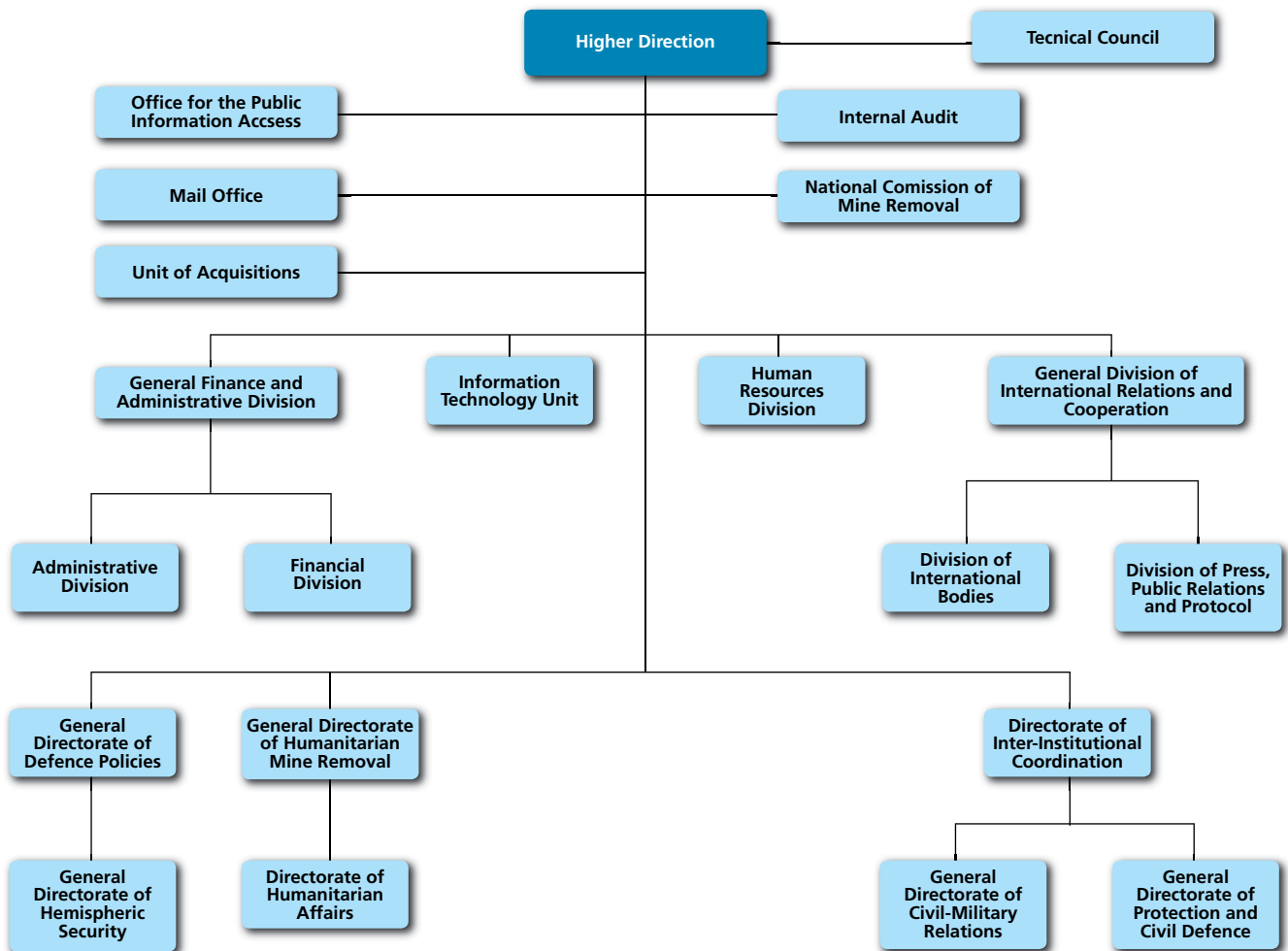

<b>Date of Foundation:</b> 1979
<b>Current Minister (September 2010):</b> Vacant position (General Secretary in charge: Ruth Esperanza Tapia Roa)
<b>Can military members be Ministers of Defence?:</b> Yes (if they have retired)
<b>Number of military members who were Ministers of Defence:</b> 2
<b>Number of civilians who were Ministers of Defence:</b> 7
<b>Have there been any women in charge of the Ministry of Defence?:</b> Yes <sup>1</sup>
<b>Average permanence in the Minister of Defence position:</b> 3 years and 1 month

[The Minister currently in charge is not considered. The creation date is related to the moment in which the term "Defence" becomes part of the Institution's name]

1 Mrs. Violeta Barrios de Chamorro held the position while serving as President of the Republic.

Source: Website of the Ministry of Defence and *Memoria del Ejército de Nicaragua: 30 años de vida institucional, 1979 – 2009.*

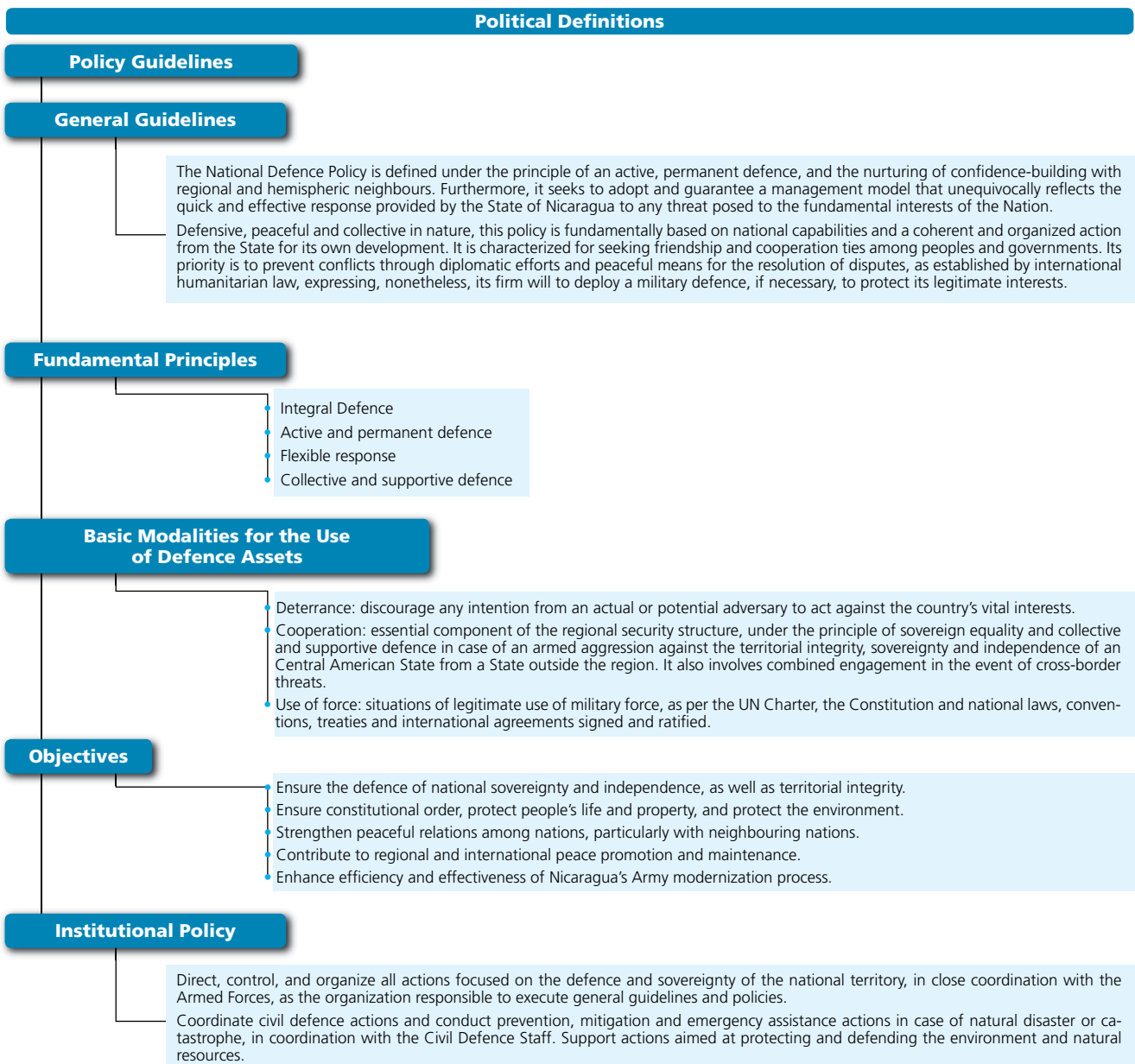

Source: *Ley anual de presupuesto general de la República 2010* and *Libro de la Defensa Nacional, 2005*.

Nicaragua published the *Libro de la Defensa Nacional de Nicaragua* (Book of the National Defence of Nicaragua) in 2005

**Reports Submitted to the United Nations and the OAS**

1997	1998	1999	2000	2001	2002	2003	2004	2005	2006	2007	2008	2009
								✘	✘			
						◇			◇	◇		
					✱	✱			✱		✱	✱

Register of Conventional Arms: ✘ Register of Military Expenditures: ◇ Implementation of Confidence and Security Building Measures: ✱

Source: Compilation based on reports submitted to the United Nations Register of Conventional Arms and the United Nations Instrument for Reporting Military Expenditures and reports submitted to the OAS on the Implementation of Confidence and Security-Building Measures.



**Military Career**

**Commissioned Officers' Career Path <sup>1</sup>**

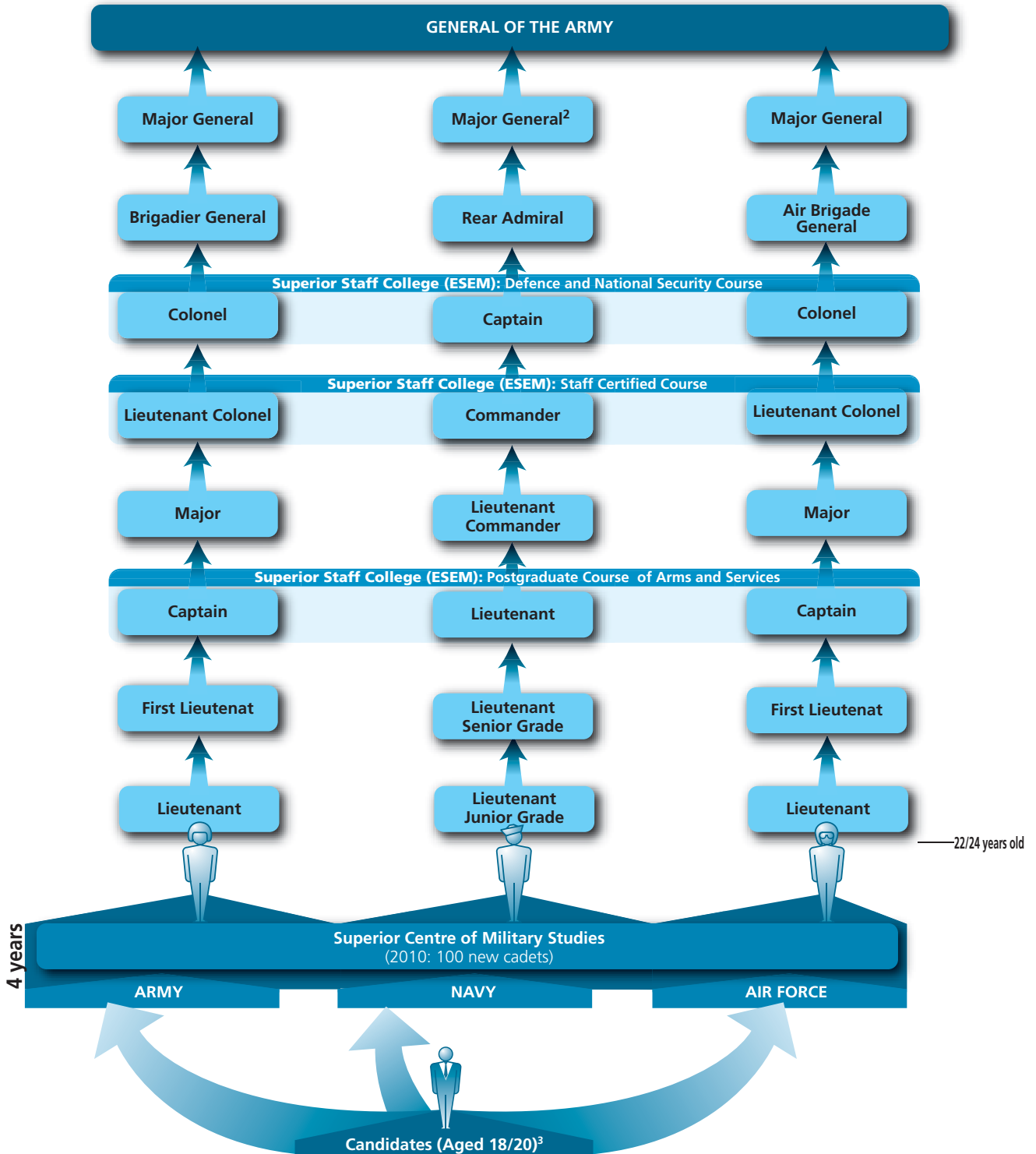

<sup>1</sup> Command corps includes officers who have been educated at military academies from the beginning of their professional careers. The graph makes a theoretical reconstruction of officers' promotion through the completion of mandatory courses. Further requirements for promotion have not been considered.

<sup>2</sup> Senior Officers of the Naval Force who hold a position in the General Command of the Nicaraguan Army shall receive the rank corresponding to the military hierarchy of the Army.

<sup>3</sup> Ages 18-20 have been considered for comparative purposes. The minimum age for promotion shall depend on the age of graduation from the military institution.

**Source:** Compilation based on *Libro de la Defensa Nacional de Nicaragua*, 2005, and websites of the Military Schools. New cadets: *Centro Superior de Estudios Militares*.

**The Armed Forces**

**General Mission**

The Army of Nicaragua is the armed institution responsible for defending the country's sovereignty, independence and territorial integrity. Only in exceptional cases, the President, in a Council of Ministers, shall be entitled to order the intervention of the Army of Nicaragua in support of the National Police, if the stability of the Republic were threatened by severe internal disorders, calamity or natural disasters. (Constitution, Sec. 92)

Its mission is to prepare, organize and lead the armed defence of the Motherland, and to defend the territorial integrity, independence and sovereignty of the Nation. At the same time, it contributes in case of extreme need, as determined by the President of the Republic, within the responsibilities set by law, in maintaining peace and public order of the Nation. In case of disasters, catastrophes and other similar situations, it conducts civil defence actions to protect and aid the population and its assets, and contribute to maintaining order and carrying out reconstruction work under civilian authorities leadership, and in coordination with them assisting in the construction of works that may contribute to the country's development, preservation and renewal of natural resources, improvement of the environment and ecologic balance as well as other strategic plans. (Código de organización, jurisdicción y previsión social militar, Act N° 181 - 1994/08/23, Sec. 2)

**Specific Missions**

**Army**

The Ground Force is the Army's main instrument to perform missions in defence of the country's sovereignty and territorial integrity, acting in coordination with the Armed Forces, the Navy and common bodies.

**Navy**

The Navy carries out missions to support the Army, and independent missions directed by the High Command of the Army

**Air Force**

The Air Force carries out missions to support the Army and Navy as well as independent missions directed by the High Command of the Army. The Land Force units which carry out missions of air defence, security and maintenance of the units and facilities fall under the Air Force.

**Total Strength: 9,412**

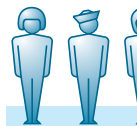

**Officers:**  
1,500

**Non-commissioned Officers:**  
302

**Troops:**  
7,610

**Total 9,412**

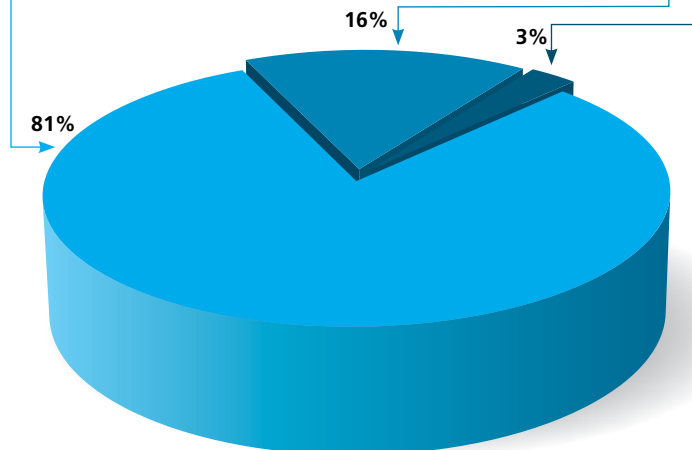

Source: Código de organización, jurisdicción y previsión social militar (N° 181 – 1994/08/23) (missions) and Ley anual de presupuesto general de la República 2010 (Regular Force).



### Women in the Armed Forces

#### Women's Admission to the Armed Forces (year)

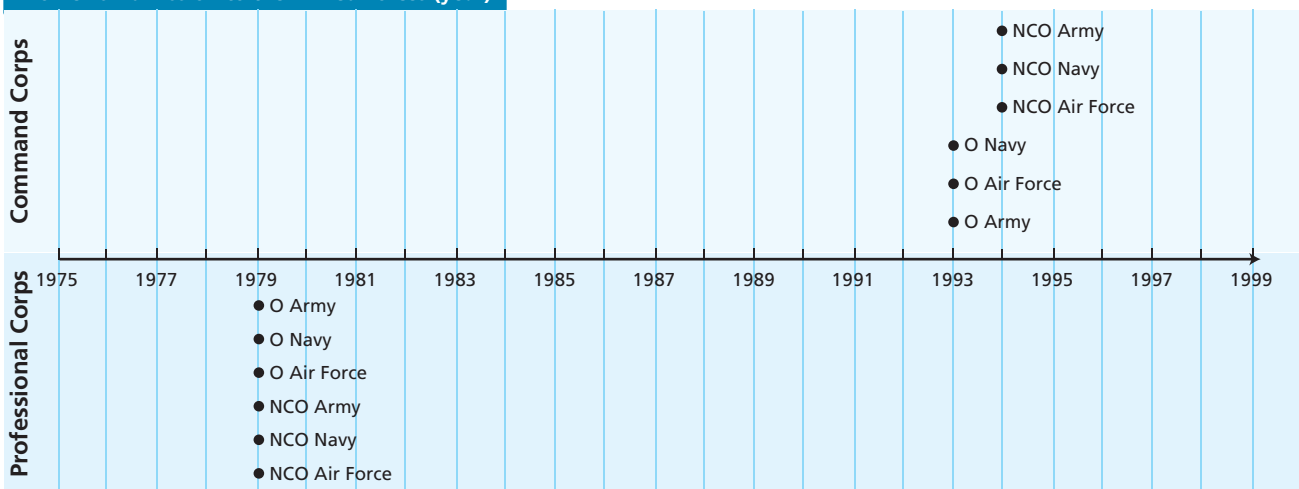

O: Officers - NCO: Non-commissioned Officers

**Source:** The Command Corps includes officers who have been educated at military academies from the beginning of their professional careers. The Professional Corps refers to those who develop a career in the civilian sphere and are then incorporated to the Armed Forces.

#### Women officer who have reached the highest rank in the Command Corps (2010)

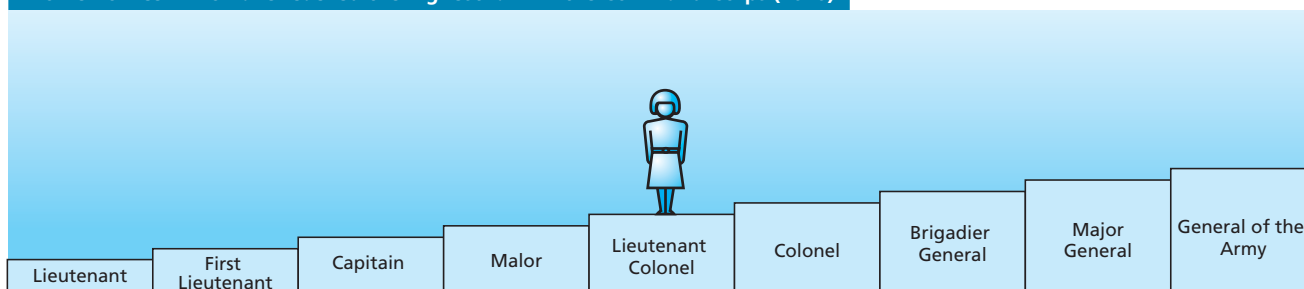

**Note:** These ranks correspond to the Army, as an example. It is considered the highest rank since the National Army was created as the only armed force of the Republic, in 1979.

**The Nicaraguan Army has 882 women appointed to different positions in the different personnel categories.**

**Source:** Memoria del Ejército de Nicaragua: 30 años de vida institucional, 1979 – 2009. And Project 07-184 Global Peace and Security Fund-RESDAL.

### Military Service

The Political Constitution forbids any type of compulsory recruitment and thus the military service is optional. Men and women are equally allowed to enter the military service, which has a one-year duration and the possibility of contract renewal.

The Nicaraguan Army is made up of 6,410 soldiers. The rank of soldier is granted to those who are graduated from Troop Training Centres or who have carried out basic courses at the Units.

Soldiers are temporary military persons and can be retained for a 3 to 5 year period. After that period they have the option of continuing on duty for an additional term.

In 1998, the National School of Basic Infantry Training “Soldado Ramón Montoya” was created (ENABI). There, the new soldiers of the Nicaraguan Army receive military training and instruction. The course has a three-month duration. From 1998 to 2009, 12,511 soldiers were graduated.

#### Some of the course's objectives are:

1. Provide basic knowledge.
2. Educate new soldiers with moral values, ethical principles and the Army military tradition and make them develop adequate physical and psychological conditions for combat missions and disaster situations caused by natural or anthropogenic events.
3. Teach soldiers to respect and observe the Constitution and the laws of the Nicaraguan Republic.

**Source:** Ley anual de presupuesto general de la República 2010 Normativa Interna Militar, 1998 and Memoria del Ejército de Nicaragua: 30 años de vida institucional, 1979 - 2009.

## Defence and National and International Community

### Support Actions

#### Permanent Countryside Security Plan and Air-Sea Operational Deployment

Its aim is to neutralize criminal actions of groups and gangs, allow the free circulation of citizens and transport vehicles and facilitate the realization of agricultural, commercial, cattle breeding and coffee-growing activities. It also aims at reducing the insecurity among the population through military and police actions in high risk areas.

From 2000 to 2009, the Nicaraguan Army carried out the following actions:

- 117,000 military patrols (infantry, motorized and naval patrols as well as combined with the National Police).
- 60,200 operation services (highway posts, ambushes, surveillance and forestall positions).
- 33,317 targets were protected and 12,893 producers received protection.
- 44 gangs made up by 2,107 criminals were broken up.
- 1,061 arms of different caliber were seized as well as 34,526 ammunitions of all sorts.
- 52 anti-smuggling operations were conducted and 1,407 head of livestock were recovered and returned back to their owners.

During 2009, the Nicaraguan Army's integral Plan to fight delinquency in countryside areas was implemented with 43,023 joint and coordinated operations by using 143,594 men of the combined forces, for the purpose of fighting and neutralizing organized crime, drug trafficking and common delinquency.

#### Army's data in the fight against drug trafficking from 2000 to 2009

- 10,722 persons connected to drug trafficking were captured.
- 180,000 marihuana plants were destroyed.

#### Seizures:

- 35,248 kilos of cocaine
- 8 light aircraft
- 45 kilos of crack stones
- 263 vehicles
- 45 kilos of heroine
- 913 war weapons
- 144 kilos of marihuana
- 1,279 small arms
- 402 crafts
- 2 rafts
- US\$ 15,071,136

### Humanitarian Demining

Among the objectives and/or areas cleared up there are 6 relay stations, 33 human settlements and cooperatives, 7 sub-stations, 1 hydroelectric plant, 514 border and littoral mine fields, 70 bridges, 378 high voltage towers and 2 air runways.

When the armed conflict finished in the 1980s, the Nicaraguan Army registered a total of 991 mined objects using 135,643 antipersonnel pressure, fragmentation, antitank mines, and 133,435 stored mines. By 1990 the magnitude of the problem demanded more resources, international support and awareness and education campaigns to prevent accidents involving mines, as well as projects to rehabilitate and reinsert the victims.

On November 27th, 1998 (Decree N° 84-98) the National Commission of Demining (CND) was created and is chaired by the Minister of Defence.

In June 2010, after cleaning Nicaragua territory, this commission fulfilled the National Programme of Humanitarian Demining, making Central America the first mine-free zone in the world.

#### National Environment Commission

Defence is involved with this commission in the decision making process regarding technical and operational aspects with the aim of determining institutional policies to promote and protect the country's natural resources (fight forestall fires, control illegal species trafficking and illegal wood cutting and transport).

#### National Forestry Commission

It is created to serve as the main advisory resource for the forestry sector. The Defence area cooperates with said commission in the elaboration, follow up, control and approval of policies, strategies and rules involving the forestry sector.

The Armed Forces cooperate with the Ministry of Environment and Natural Resources (MARENA) and with the National Forestry Institute (INAFOR) to ensure compliance with the laws for the protection and preservation of natural resources and the environment in protected areas, such as the biologic reservations of Bosawás, Indio-Maíz and the wild life refuge of Chacocente and La Flor. They carry out activities to patrol and protect the objectives and the natural resources as well as forestation campaigns in Managua Lake basin and in all Regional Military Commands.

From 2002 to 2009, the Nicaraguan Army took part in:

- 200 health events
- 57 abatization events
- 114 cleaning campaigns
- 20 vaccination campaigns
- 13 blood donation campaigns
- 15 fumigation campaigns
- 5,711 military troops took part and 418 vehicles were used (285 heavy vehicles and 135 light vehicles).

#### Infrastructure

Between 2006 and 2009, 77 km of roads were repaired and other 151 km were constructed. Besides, works of drainage and bridges were carried out.

The communication system was strengthened and 81 radio stations were added, thus enlarging early warning system coverage.

#### Staff of the Civil Defence of the Army

Created in 1982, the Staff of the Civil Defence of the Army (EMDC) is the Nicaraguan Army's specialized body that provides continuous aid to the population in case of disaster.

#### Participation in the following main emergencies:

1988 - Hurricane Joan: evacuation of 321,372 people.

1992 - Tsunami

1998 - Hurricane Mitch

2000 - Masaya Earthquake

2004 - Musún Hill landslide

2005 - Beta Hurricane: evacuation of 11,904 people. Deployment of 4,824 military troops and civil defence officers, and 112 means of transport of all kinds.

2007 - Felix Hurricane: evacuation of 19,726 people. Use of 166 ground, water and air means of transport.

Source: Website of the Humanitarian Demining Programme in Central America - OAS and the Ministry of Defense, *Libro de la Defensa Nacional de Nicaragua, 2005* and *Memoria 2009 del Ejército de Nicaragua* and *Memoria del Ejército de Nicaragua: 30 años de vida institucional. 1979 - 2009*.



Analysis:

## From Guerrilla to Institutional Consolidation: the Special Evolution of the Nicaraguan Army

**Carlos Arroyo Borgen**

*Professor of the American University and expert on security and defence matters.*

On September 2, 2009, the Army of Nicaragua, in other times known as the People's Sandinista Army, celebrated its 30th anniversary. After three decades, it is time to reflect on some of the main achievements, errors and challenges of the military institution.

The origins of the Nicaraguan Army, first as a guerilla movement in the insurrectional fight against Anastasio Somoza Debayle's administration and then as the armed wing of the Sandinista National Liberation Front (FSLN, Spanish acronym), is not unknown. Precisely, on July 19, 1979, following the success of the Nicaraguan revolution and the establishment of the National Reconstruction Government Board (JGRN) the Fundamental Statute of the Republic of Nicaragua was passed as the supreme provisional regulation, which revoked old formal power structures and laid the bases for the new institutional order. On August 22, 1979 the JGRN ordered the creation of the People's Sandinista Army (EPS) through Decree N° 54 dated September 18, naming its main commanders and starting the conformation of military structures and units around the country, made up based on the guerilla forces.<sup>1</sup>

Between 1980 and 1982, laws were enacted to govern the newly born armed forces: the Organization of the

Military Audit Office and Provisional Criminal Military Procedure, of Military Offenses, the Disciplinary Regulations, combat regulations and additional provisions. The following years would be the most difficult for the military organization in terms of constructing their identity, independent from that of the party in the government, and becoming a truly professional institution of a national character, since its officers have been educated in a war context under a model that considering the military as an integrated part of the revolutionary process within a formula "State-Party-Army."

The creation of new armed forces with a partisan character such as the People's Sandinista Army showed that Nicaragua still had to wait to have a military institution really representative of the society and the nation as a whole. From an armed corps serving the interests serving the interests of a family as the National Guard had been, the institution became an army serving the interests of a party. Immediately after the 1990 elections, the then called People's Sandinista Army with over 130,000 soldiers and consuming almost 60% of the national budget, had to face deep transformations. The democratic transition was accompanied by a much needed and severe reduction of military strength and defence spending. Under this logic, three licensing plans and several retirement schemes were implemented since 1990 until the configuration of an army with approximately 12,000

<sup>1</sup> Ministry of Defence and Army of Nicaragua., *Libro de la Defensa Nacional de Nicaragua*, (Managua: Impresión Comercial La Prensa, 2005), Chapter V.

men. From 1990 to 1996 the Army's budget shrank from US\$177 million to about US\$30 million, which at a time represented 1.6% of the GDP. The reduction implemented in a period shorter than five years represented over 80% and its main goal was adjusting the military body structure to a viable size in both the institutional and the political senses.

At the same time, actions were taken inside the armed forces to speed up the separation of servicemen from party positions, the prohibition to participate in partisan politics and the removal of political and partisan positions from the military structure.

Once the political transition was open context characteristics placed the Army at a privileged place to give shape and define the depth and speed of the changes that would be introduced in the defence sector, adjusting them to their fledgling corporate interests. The '90s was also a stage of fast, permanent and significant movements in the political context in Nicaragua, which demanded dire efforts from the new civilian leadership to establish priorities and competing with other issues on the national agenda.

The task of the military institution then, was its own consolidation, vis-à-vis a set of fragmented actors that were still struggled to reshape the political system, which had been unable to articulate a hegemonic power to lead the transition and had failed to attain a sound institutionality for the new regime.<sup>2</sup> With the 1995 constitutional reforms, the bases were set for the national, professional, non-partisan, obedient and non-deliberating character of the military institution from that moment onwards, as well as their subordination to President of the Republic or the relevant ministry. Finally, the Military Internal Regulation was passed in 1998, which defines the military career. These actions were thought in terms of giving the military organization a legal framework ensuring their legitimacy and legality and safeguarding institutional stability vis-à-vis the unsolved conflicts of the actors within the political system and the State itself.

Consequently, the conversion of the defence sector was not due, either in its concept or in its execution, to a strategic design devised by a civilian leadership. As a result, asymmetrical and imperfect transformations were attained, inarticulate and managed for the convenience of a military structure with proven experience and enhanced negotiation skills.

This repositioning is thus a consequence of specific negotiations with the civilian leaders in power, in which, in exchange for political support, time was bought to implement reforms. Hence, from the mid-90's to the present time, the Army has succeeded in taking advantage of its relative autonomy before complacent civil authorities to gradually extend their sphere of influence, particularly in two specific areas which could divert their nature and the primary role they have been reserved: 1) the concerning and disproportionate expansion of their non-conventional missions (support to the combat to drug-trafficking and terrorism, response to natural disasters, vaccination operations and forest fire prevention, among others); and 2) the recurring suspicion over the expansion and transparency of their business activities.

All this said, it is fair to acknowledge that the Army of Nicaragua has devoted the first decade of the new century to ever more reducing its political transcendence and focus mainly on its own modernization and professionalization processes. In an opposite direction to the course taken by the military, the permanent fragility of key civilian institutions and discredited Nicaraguan political leaders coupled with the ever more frequent actions of a humanitarian character undertaken by the Army as part of its new missions, have made of the military institution --together with the media and the Catholic church-- one of the most trusted and credible organizations for the population. Recent polls reveal that 8 out of 10 Nicaraguans express they have high or some trust in the Army, with the best evaluated activities being the protection of the people in natural disasters (85.5%), the fight against international drug trafficking (81.3%) and the security of borders (78.4%).<sup>3</sup>

This 30th anniversary finds an Army in the process of consolidation with deep implications to the country's democracy and governance, as they directly relate to the model of military institution that is being generated --national and professional-- and the type of relationship with the Nicaraguan State and society. Remaining aside from political interests and projects dominating the complex Nicaraguan context represents the immediate challenge of the Army of Nicaragua and, to a large extent, this will depend on whether the institutional achievements attained until now are not reversed and that the trust the citizenry has deposited on its service men is not betrayed.

<sup>2</sup> Elvira Cuadra, *Las relaciones entre civiles y militares en Nicaragua: Reanudando el debate*, (Managua: Presentation at the updating workshop sponsored by the Universidad para la Paz. UPOLI, 2003).

<sup>3</sup> M&R Consultores, "*Nicaragua, Sistema de Monitoreo de la Opinión Pública (SISMO) Edición XXV Junio 2010*", <http://www.myrcconsultores.com/page/estudios.html>





# Paraguay

## The Legal Framework and the Defence System

### National Legislation

#### Systems and Concepts

- National Defence and Internal Security Act (N° 1.337 - 1999/04/14)
- Act which establishes the Border Security Zone (N° 2.532 - 2005/02/17)

#### Military Organization

- Obligatory Military Service Act (N° 569 - 1975/12/24. Last amendment: Law N° 3.360 - 2007/11/02)
- Organic Act of Military Courts (N° 840 - 1980/12/19)
- Military Penal Code (Act N° 843 - 1980/12/19)
- Code of Military Penal Procedures in War and Peace Times (Act N° 844 - 1980/12/19)
- General Organization of the National Armed Forces Act (N° 74 - 1991/11/20. Last amendment: Act N° 216 - 1993/06/16)
- Act of the Military Personnel Statute (N° 1.115 - 1997/08/27. Last amendment: Law N° 2.879 - 2006/04/06)
- Firearms, Ammunition and Explosives Act (N° 1.910 - 2002/06/19)
- Act on the Right to Conscientious Objection (N° 4.013 - 2010/06/17)

— Advisory and assistance functional relationship  
 — Command reporting line

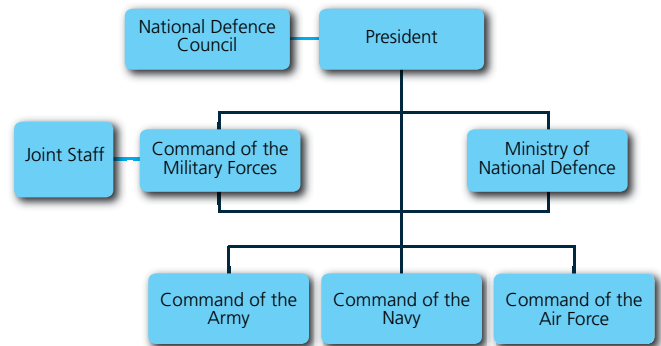

The President's advisory and consultative body is the National Defence Council, composed of the Ministers of Defence, Foreign Affairs and Interior, the highest-ranking General Officer, the Chairman of the Joint Chiefs of Staff, the official in charge of the State Intelligence Agency and its Permanent Secretary. The Ministry of Defence performs the administrative functions of the Armed Forces. The Commander of the Armed Forces holds the effective command of the Armed Forces as delegated by the President. He has the Joint Staff as the planning, advisory and coordinating body. The Congress holds the powers granted by the Constitution and permanently monitors defence related issues through the specific committees in both Houses.

**Source:** Compilation based on the Political Constitution, *Ley de defensa nacional y de seguridad interna* (N° 1.337 - 1999/04/14), and *Ley de organización general de las Fuerzas Armadas de la Nación* (N° 74 - 1991/11/20. Last amendment: Act N° 216 - 1993/06/16).

**Source:** Compilation based on the legislation above mentioned. For constitutional provisions see Chapter 1.

## The Budget

Year	Defence Budget (in US\$)	Government Budget (in US\$)	GDP (in US\$)
2006	95,572,924	3,365,388,001	7,629,000,000
2007	126,711,873	4,351,047,350	10,347,000,000
2008	149,580,691	5,097,997,863	12,076,000,000
2009	176,769,687	6,546,922,124	13,611,000,000
2010	227,582,002	7,611,749,604	17,311,000,000

### Defence Budget (in %)

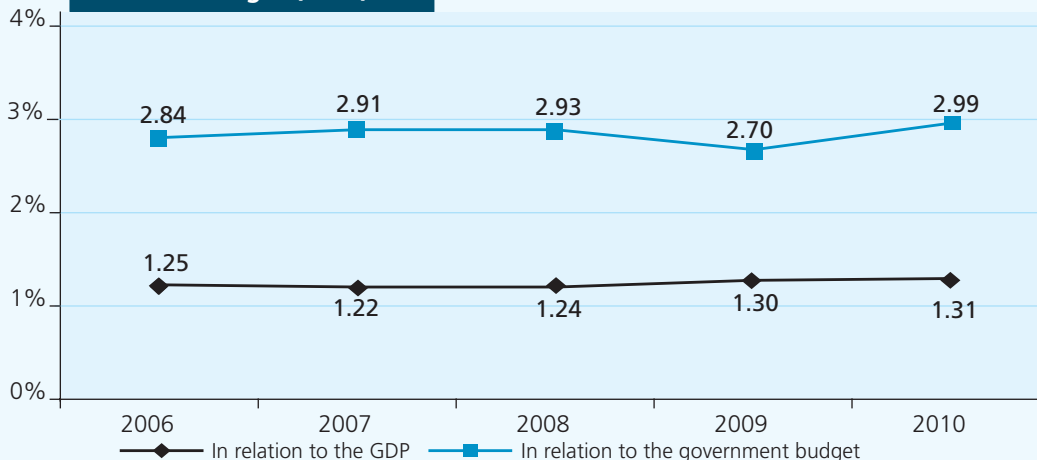

**Defence Budget Breakdown**

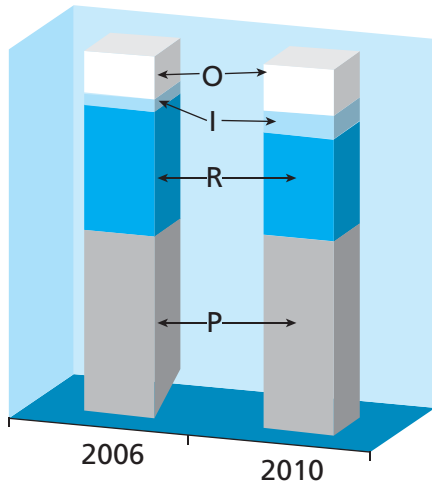

**P:** Salaries and other benefits  
**R:** Retirement and pension funds / **I:** Investment  
**O:** Other expenses

**Comparative Increase (% variation 2006-2010)**

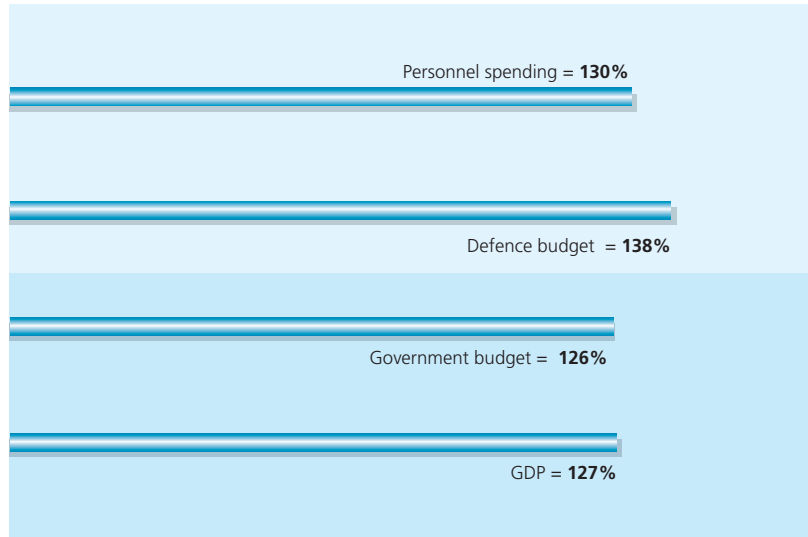

**Defence Budget 2010 (in Local Currency)**

Entities	Personnel Services	Non-personnel Services	Materials and Supplies	Others*	TOTAL
<b>National Defence Ministry</b>					
General Management/Administration	9,649,131,306	4,930,282,312	1,985,784,431	2,864,077,582	19,429,275,631
Command in Chief	49,127,860,071	15,676,449,133	10,694,794,611	51,684,384,431	127,183,488,246
Land Forces	349,746,343,087	4,299,962,106	37,249,570,001	8,326,171,847	399,622,047,041
Air Force	68,476,499,425	1,946,224,026	12,535,718,825	17,084,186,539	100,042,628,815
Navy	94,368,567,608	3,016,630,613	9,006,961,874	8,301,250,443	114,693,410,538
<b>Presidency</b>					
National Defence Council	238,506,800	7,877,703	6,455,609	0	252,840,112
Military Cabinet	2,375,980,600	400,125,000	1,374,003,200	1,896,240,342	6,046,349,142
<b>Treasury Ministry</b>					
Retirements and Pensions of the Armed Forces	0	0	0	293,981,246,988	293,981,246,988
<b>TOTAL</b>	<b>573,982,888,897</b>	<b>30,277,550,893</b>	<b>72,853,288,551</b>	<b>384,137,558,172</b>	<b>1,061,251,286,513</b>

\* Includes physical investment, inventories, financial investment and other expenses.

**Composition of Defence Budget 2010**

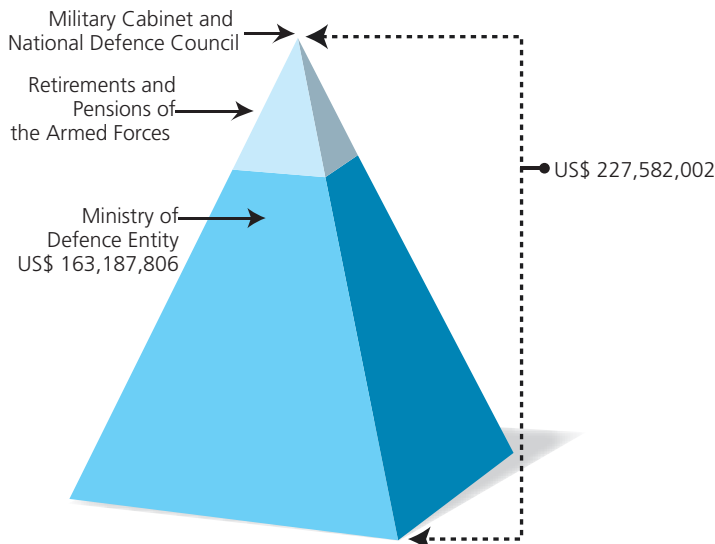

**In 2009 and 2010, the Ministry of Defence received US\$ 21,392,109 for military and security equipment acquisitions. This amount accounts for 5.29% of the allocated defence budget for those years.**

**Source:** Compilation based on *Ley de presupuesto general de la Nación para el ejercicio fiscal 2006, 2007, 2008, 2009 and 2010*. The State Budget passed by the Congress by means of the above mentioned Act is considered herein. The concept of investment is that expressed in "Physical investment".  
 GDP: Projection of the World Economic Outlook Database, IMF, of each year under review. This source has been taken for comparative purposes. Each country prepares the budget based on its own GDP estimation.  
 The dollar value considered corresponds to the exchange rate determined by the World Economic Outlook Database, IMF, for each year under consideration. As of July, the 2010 exchange rate average is 4,711.47 Guaranies, based on the data provided by the Central Bank of Paraguay. For further calculations, figures are provided in local currency.  
 Expressions in Bold Type (Table) make reference to the various defence budget items, which can be found in a sector-based or institutional classification of the Budget Act.



**The Ministry of National Defence**

**Responsibility:**

The administrative responsibilities of the Nation's Armed Forces fall under the National Ministry of Defence.  
 (Ley de organización general de las Fuerzas Armadas de la Nación, Nº 74 – 1991/11/20. Last amendment: Act Nº 216 – 1993/06/16, Sec. 48)

**Organization Chart**

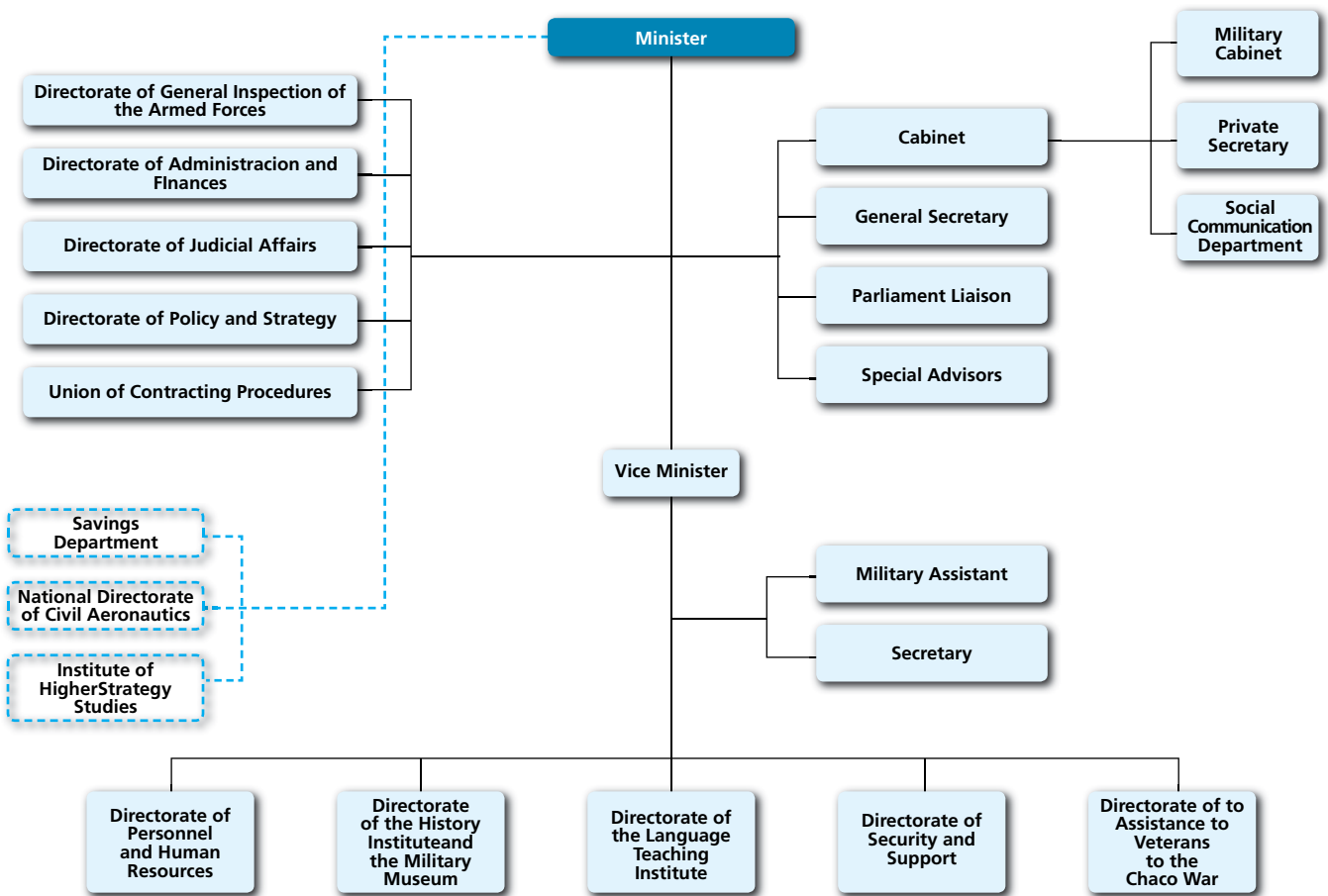

<b>Date of Foundation:</b> 1943
<b>Current Minister (September 2010):</b> Cecilio Pérez Bordón
<b>Can military members be Ministers of Defence?:</b> Yes (if they have retired)
<b>Number of military members who were Ministers of Defence:</b> 18
<b>Number of civilians who were Ministers of Defence:</b> 5
<b>Have there been any women in charge of the Ministry of Defence?:</b> No
<b>Average permanence in the Minister of Defence position:</b> 2 years and 11 months

[The Minister currently in charge is not considered. The creation date is related to the moment in which the term "Defence" becomes part of the Institution's name]

Source: Compilation based on information provided by the Ministry of National Defence.

**Political Definitions**

**Policy Guidelines**

**Strategic Objective:** To recover national sovereignty. As part of eleven strategic tenets, this one aims at restoring the national power's supreme authority for the Paraguayan people. For this purpose, the recovery of the Nation's territorial, energy, food and cultural sovereignty will be promoted, and citizen democratic and prominent involvement will be encouraged.

**Programmes and Objectives for the Sector**

**Fluvial Defence and Environmental Protection**

- Ensure the sovereignty and integrity of river and maritime interests.
- Defend democracy and the legitimate authorities.
- Maintain the Paraguayan Navy in operational conditions.
- Recruit and train citizens called up to serve the compulsory military service.
- Cooperate in civil defence, environmental protection, and internal order control.
- Protect the fluvial borders and naval areas' inviolability.
- Conduct independent strategic actions and service-specific, joint and combined operations.
- Cooperate in the fight against drug trafficking.

**Air Force Organization, Training and Equipment**

- Recover unserviceable aeronautical material so as to strengthen the number of operational aircraft.
- Adapt the training equipment and update course curriculum structure.
- Improve the buildings' infrastructure of bases and facilities, and increase compliance with environmental preservation requirements under the Air Force area of responsibility.

**Senior Leadership of the Armed Forces**

- Efficiently comply with the mission assigned by the National Constitution and national laws in force.
- Strengthen reaction capacity against any action that may jeopardize the Rule of Law or national sovereignty.
- Equip and support each individual service (Army, Navy, and Air Force) in the exercise of its institutional mission.

**Defence of Territorial Integrity**

- Cooperate in the protection of the country's territorial integrity and defend the country's legitimate authorities.
- Exert control and develop policies for the Paraguayan Army's military operations.
- Artillery fire support to military operations.
- Communications support to military operations.
- Train and instruct officers and NCOs for special operations.
- Cooperate with the Civil Defence Authority in case of public disaster.
- Protect the 3,498 km long land border, with Army corps and divisions, including their respective military bases and posts.

**Localization and Control of Border Security Areas**

- Establish a border security line within 50 km. parallel to the country's borders.

**Administration**

- Train and educate human resources.
- Effectively administer available material and financial resources.
- Coordinate tasks and activities among different areas.
- Provide the necessary building infrastructure with office and IT equipment.
- Improve administrative transparency.
- Provide integral healthcare services to service members.

**National Prevention and Biological Emergency Response Commission**

- Design actions and implement measures for the prevention and execution of biological emergency response plans.
- Prevent and respond, in an adequate and timely manner, to emergencies caused by biological, chemical, or radioactive agents, or other mass destruction weapons, caused by accident or terrorist attack, thus contributing to the security of the people and the environment.

**Assistance to Chaco's War Veterans**

- Complete assistance to Chaco's war veterans and their heirs.

**Training and Learning**

- Train military and civilian professionals on national defence and strategy matters, development and language learning.

Source: Informe del Gobierno Nacional 2009 and Ley de presupuesto general de la Nación para el ejercicio fiscal 2010

Paraguay published the *Política de Defensa Nacional de la República del Paraguay* (National Defence Policy of the Republic of Paraguay) in 1999.

**Reports Submitted to the United Nations and the OAS**

1997	1998	1999	2000	2001	2002	2003	2004	2005	2006	2007	2008	2009
✘		✘	✘	✘	✘	✘	✘	✘	✘			
		◊				◊			◊	◊		
										✱	✱	✱

Register of Conventional Arms: ✘ Register of Military Expenditures: ◊ Implementation of Confidence and Security Building Measures: ✱

Source: Compilation based on reports submitted to the United Nations Register of Conventional Arms and the United Nations Instrument for Reporting Military Expenditures and reports submitted to the OAS on the Implementation of Confidence and Security-Building Measures.

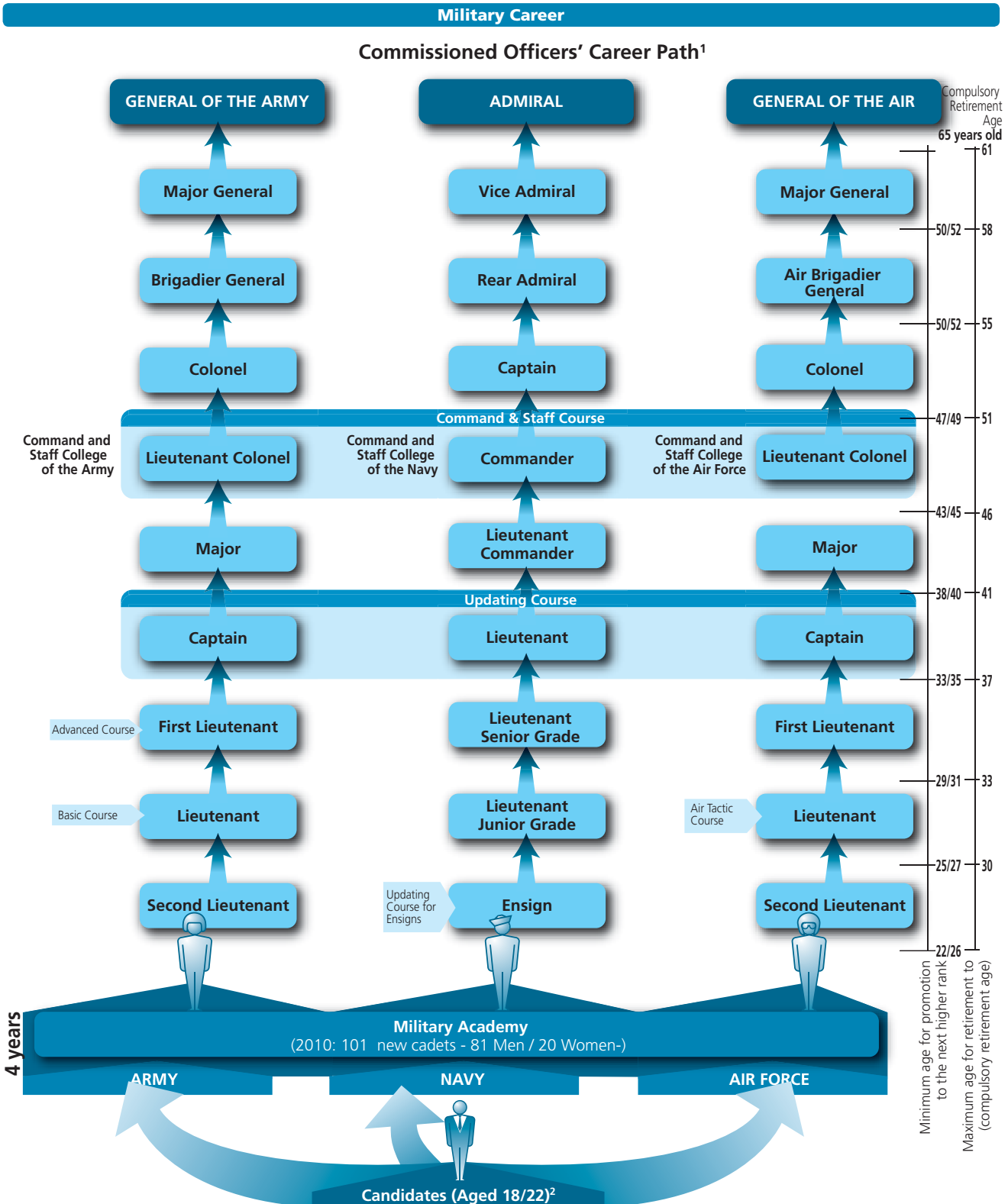

1. Command corps includes officers who have been educated at military academies from the beginning of their professional careers. The graph makes a theoretical reconstruction of officers' promotion through the completion of mandatory courses. Further requirements for promotion have not been considered.  
 2. Ages 18-22 have been considered for comparative purposes. The minimum age for promotion will depend on the age of graduation from the military institution.

Source: Compilation based on Ley del estatuto del personal militar (Nº 1.115 - 27/08/1997. Last reform: Law Nº 2.879 - 2006/04/06). New cadets: Information provided by the Ministry of National Defence

**The Armed Forces**

**General Mission**

The mission of the Armed Forces is to safeguard the territorial integrity and to defend the legitimately established authorities.  
 (Constitution, Sec. 173)  
 To comply with its objectives, the Armed Forces of the Nation shall maintain the inviolability of land, fluvial and air space borders; organize, equip and train forces to face any type of aggression; organize, manage and administer reserves. They also cooperate in civil defence; and cooperate in restoring internal order when the President of the Republic deems it necessary based on an issued decree.  
 (Ley de organización general de las Fuerzas Armadas de la Nación, N° 74 - 1991/11/20. Last amendment: Act N° 216 - 1993/06/16, Sec. 7)

**Specific Missions**

**Army**

The Army is a land force which performs strategic operations, plans, prepares and directs operations in its organic units and others under its command, to which it supports in carrying out specific missions.

**Navy**

The Navy is the Service that has the responsibility to execute specific missions of a naval nature.

**Air Force**

The Air Force is responsible for the custody and defence of the national air space and for executing operations to comply with its mission.

**Total Strength: 12,200**

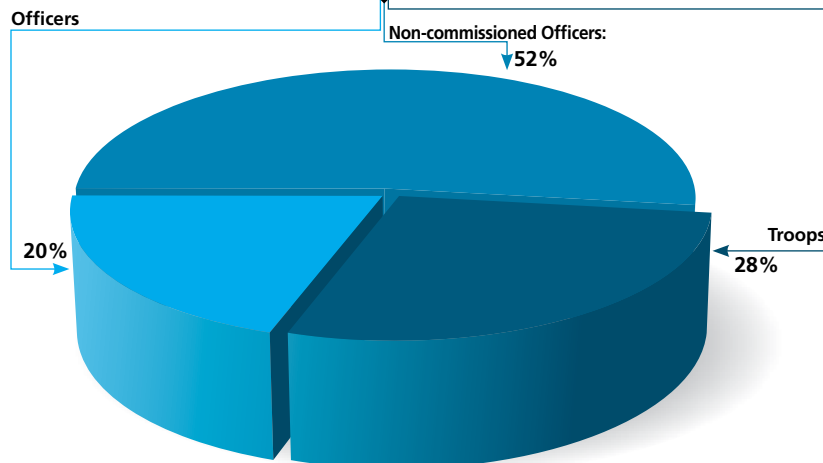
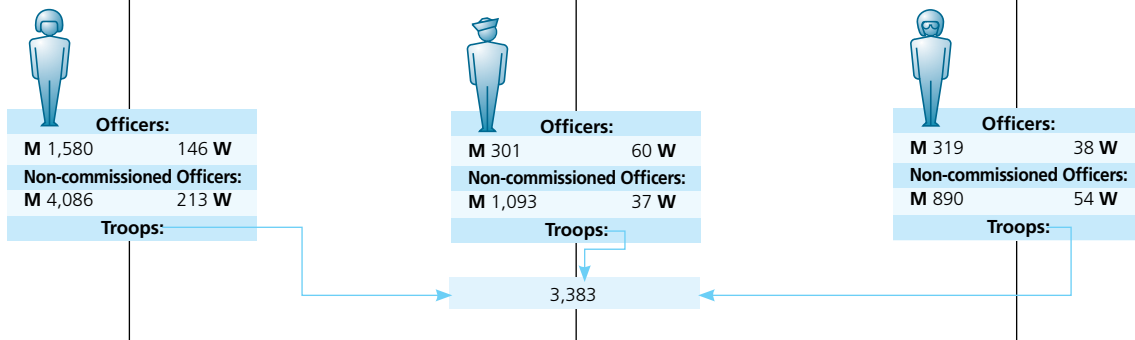

M: Men / W: Women

Source: Ley de organización general de las Fuerzas Armadas de la Nación (N° 74 - 1991/11/20. Last amendment: Act N° 216 - 1993/06/16) (missions) and information provided by the Ministry of National Defence (regular forces).



**Women in the Armed Forces**

**Women's Admission to the Armed Forces (year)**

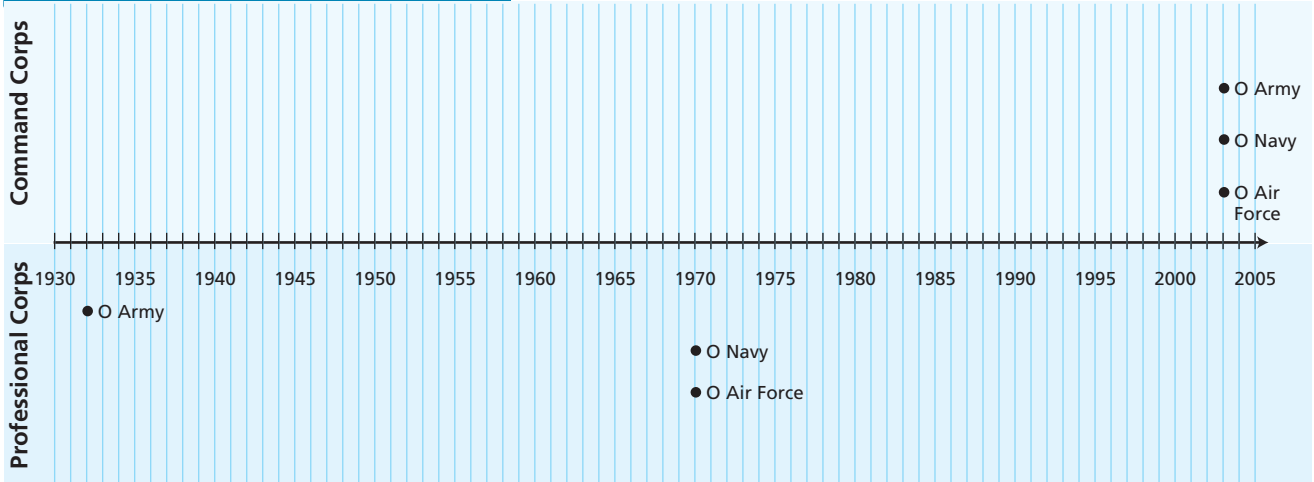

O: Officers

**Note:** Women do not enter the Armed Forces in the category of career personnel at NCO level. The Command corps includes officers who have been educated at military academies from the beginning of their professional careers. The Professional corps refers to those who develop a career in the civilian sphere and are then incorporated to the armed forces.

**Women Officers who have reached the highest rank in the Command Corps (2010)**

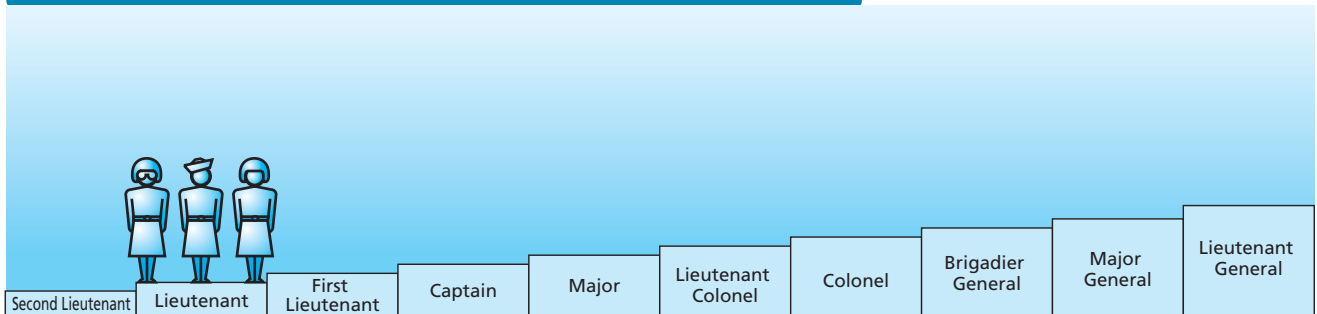

**Note:** These ranks correspond to the Army, as an example. The equivalent ranks for Lieutenant is Lieutenant Junior Grade in the Navy and the same in Air Force

**6.22 % (548) of the total Armed Forces are women.**

**Military Service**

It is compulsory for male citizens to enter the military service for a period of one year. Women may be called in the event of international war, to perform logistic and administrative activities, as well as to provide other services according to the requirements arising from the war. However, the National Constitution recognizes the objection based on conscience due to ethical or religious beliefs. People who assert their objection based on conscience shall provide services to the civil population by working in assistance centres.

**Draftees:**

Citizens who have the age required to be enlisted, who are listed and called to provide services. The following table shows the number of draftees assigned to each division of the Forces.

	Number of Draftees of the Armed Forces	
	2009	2010 (1 <sup>o</sup> Semester)
Army	2,632	1,376
Navy	468	392
Air Force	236	133
Ministry of Defence	56	34
Others	535	328
Total	3,927	2,263

**Source:** Information provided by the Ministry of National Defence, *Ley de servicio militar obligatorio* (N°569 - 1975/12/24. Last amendment: Act N°3.360 - 2007/11/02) and Project 07-184 Global Peace and Security Fund-Resdal.

## Defence and National and International Community

### Participation in Peace Operations

Current Missions	Military Component			
	MEM		MC	
	Men	Women	Men	Women
MINURSO (Western Sahara)	2	-	-	-
MINUSTAH (Haiti)	-	-	31	-
MONUSCO (Dem. Rep. of the Congo)	17	-	-	-
UNFICYP (Cyprus)	-	-	14	-
UNMIL (Liberia)	2	-	1	-
UNMIN (Nepal)	6	-	-	-
UNMIS (Sudan)	6	-	-	-
UNOCI (Ivory Coast)	8	-	2	-

MEM: Military experts on mission, including military observers, judge advocates and military liaison officers, among others - MC: Military Contingent.

The Joint Training Centre for Peacekeeping Operations, CECOPAZ, was created in October 8, 2001.

In 2009, 181 military troops and civilians were trained there on peacekeeping operations.



Paraguay contributes 89 military troops to the United Nations peacekeeping missions, which represents 1.16% of the total contribution of Latin America.

Currently, 14 Paraguayan troops integrate the Argentine contingent (FTA 36) in the United Nations Peacekeeping Force in Cyprus (UNFICYP). Likewise, 31 Paraguayan troops are currently part of the United Nations Stabilization Mission in Haiti (MINUSTAH), making up the Brazilian contingent (BRABATT XIII).

**Source:** Compilation based on documents from the Department of Peacekeeping Operations of the United Nations (data as of 31 August 2010) and websites of the CAECOPAZ and the Army of Brazil.

### Support Actions

#### Support to the Ministry of Public Health and Social Welfare

Assistance was provided through materials, human resources, fuel and vehicles, used to fight epidemics such as cholera, dengue, yellow fever, AIDS, etc.

#### Support to the Ministry of Education and Culture

Support was provided for the repair of 57 schools, using:

- 57 vehicles
- 253 public officers
- 57 work team leaders

#### "Ñepohano" Operatives

The Armed Forces of Paraguay, with the logistics support of the United States, cooperated with the Ministry of Public Health in free medical assistance operations for low income adults and children: general medicine, ophthalmology, pediatrics, gynecology, vaccination, anti-parasite campaigns, family planning, talks on drug addiction and new epidemics, and distribution of medicines free of charge.

- ÑEPOHANO 04, from January 27 to February 2, 2009: 9,197 people were assisted.
- ÑEPOHANO 05, from May 29 to June 1, 2009: 6,081 people were assisted.
- ÑEPOHANO 06, August 7-10, 2009: 6,000 people were assisted.

Medical-dental care was provided to 41,000 civilians from rural areas.

Educational assistance to national and foreign institutions, through the Institute of History and the Military Museum of the Ministry of National Defence, for the promotion and dissemination of military history. Several free guided visits were performed for primary schools and highschools, both public and private, universities and international institutions.

The Armed Forces received a donation of 25,000 plants, which are being planted by military personnel within the framework of the Tree Planting Plan.

Paraguay's Air Force carries out air medical evacuations to assist the population in accidents or disasters.

Maintenance of rural roads, restoration and opening of new roads in charge of the Army Engineering Command (COMINGE), in coordination with the Ministry of Public Works and Communications (MOPC).

Literacy courses were developed in 2009 for the civil population in different headquarters across the country, as well as training courses on Human Rights and Humanitarian International Law.

**Source:** Informe 2009 del Gobierno Nacional, Memoria Institucional 2009 Paraguay and websites of the Parliament and the Air Force.





Analisis:

## The Armed Forces' Modernization Process

**Richard Ferreira**

*Journalist, Última Hora Newspaper*

Paraguay continues the process of change commenced in 2008 with the coming into office of the former Catholic bishop Fernando Lugo. The Government renovation pillars are well backed in the political, structural and cultural spheres. Also within these three focuses of attention, as proclaimed by governmental authorities, are the security institutions, considered lagging behind this modernity era, and having made few changes, above all in their structure.

Since the fall of Alfredo Stroessner's dictatorship in 1989 a democratic process commenced which now sees the opening of a new political process with the change in the political sign in 2008. The armed forces have been one of the institutions that had to adapt to the new times since the return of democracy. Although with tension in certain periods, the emergence of a political leader such as Lino Oviedo, and occasionally, with the potential of institutional breakdown, the armed forces have consolidated before society as democratic institutions committed to the defence of national interests and the Constitution.

Corruption in some of its areas, the size of its structure, the scarcity of budgetary resources for modernization, and the political indifference to the reform of old legislative schemes, are some of the negative aspects that have been observed.

### Ministers

It is against the law to name an active duty military officer as Minister of Defence. During all the democratic period, that Office of the State has been managed by civilians or retired generals.

Reviewing part of the history, the government of Nicanor Duarte Frutos (2003-2008) decided not to name a retired military as Minister of Defence. All those who were in office during that administration were civilians of the Colorado Party, including Carlos Romero Pereira, Roberto González and Nelson Mora. Fernando Lugo chose a retired general, Luis Bareiro Spain, a military officer with an impeccable track record. According to his own statement, his objectives for this presidential period were 'institutionalizing and modernizing the Armed Forces'.

The relation between the President of the Republic, the Minister of Defence and the Armed Forces over the almost three years of President Lugo's government has been focused on good relations. No severe conflict which might endanger grave institutional disruption has been heard of.

However, March 2010 was the moment of the greatest political tension in the area related to the Ministry of Defence. Minister Bareiro Spain was involved in a debate that had diplomatic and political repercussions. A letter sent by Minister Spain to the US Ambassador to Paraguay, Liliana Ayalde, questioning an alleged

interference in internal affairs triggered the scandal. This derived in escalating tension that involved the Congress, subject to the dominance of the opposition, which summoned the minister and questioned him seeking clarification. While the American Embassy tried to turn over the page, the political environment was ever more altered. The opposition demanded the minister's destitution on this account and on account of other alleged irregularities. President Lugo backed the minister and ratified his position. However, the Minister eventually resigned in August 2010 when the Congress requested his impeachment after three M-16 rifles had been stolen from the Army Command.

### Reform

A few years after the fall of Stroessner's military dictatorship, there was an attempt to reform the armed forces. Two laws were passed (one in 1991 and the second in 1993) where a general reorganization of the armed forces was contemplated, although no substantial change was introduced. On different subsequent occasions certain laws related to military organization were attempted, especially in 2007. The initiative did not prosper, however.

Once the Lugo administration was in office and with the presence of a retired military leading the Ministry of Defence, the debate over armed forces reform started once again. The tepid initial response of the Executive branch was accelerated by a regional situation that can be summarized as an arms build-up fever. Bolivia, a Paraguayan neighbour with a historic claim to the Paraguayan Chaco, also seemed to take to that course, which generated a strong discussion among politicians and analysts in Paraguay about the need to dig out old projects focusing the modernization of the armed forces.

The then Minister of Defence announced that it had decided to implement a set of proposals to attain military reorganization. One of the ideas set forth: including the Minister of Defence in the chain of command. Minister Bareiro Spaini himself explained it in the following terms: "The Minister of Defence must be included in the military command chain because such setup would contribute to armed forces modernization."

Until July 2010, the Executive Branch had not sent to Congress a bill for Armed Forces reorganization, although some of its points were discussed in the political environment after the leak to the media of some of the draft items.

### The Proposals

The Ministry of Defence has an armed forces restruc-

turing project which, among other things, proposes to eliminate the Command of Military Forces, substituting all three Army corps and change the name of the mandatory military service, according to information of the *Ultima Hora* newspaper, which had access to the bill draft.

The plan provides for the replacement of the Command of the Military Forces by a new institution called Defence Staff (*Estado Mayor de la Defensa*), the fundamental objective of which will be the strategic planning of everything related to the country's defence and security. According to the official explanation, the Joint Staff will become the Defence Staff which will be presided over by the Minister of Defence, once its inclusion in the command chain is implemented.

Its head would be the General with the highest seniority in the military ranks. The departments will be comprised of members from the three services and their respective Staffs shall be under charge of senior officers.

In the same manner, the Defence Staff would assist and advise the Minister of Defence and would be the hands-on work body in the crises committee, according to the official explanation.

There is also mention of the need to replace all three Army corps by three Army divisions. Brigades would be created with flexible and versatile elements, so as to ensure fast and effective response. The idea is to reduce the number of operating units. At this time, there are three Army corps which are considered as a large unit or an exaggerated command. There would be better capabilities to act with more speed, operability, and economy of financial and human resources; and the incomplete units would be reinforced with personnel needed.

An additional action is the proposed reduction of Armed Forces' bureaucratic and administrative structures to a minimum. As counterpart, priority would be given to combined service groups.

The institutionalization and modernization is directly tied to the legal reform. However, the discussion of actual projects has not taken place in Parliament.

The time of discussing the reorganization of the armed forces seem to be near, although no date or time have been set. The authoritarian remnants represented in Congress by some lawmakers and the winds of change are set to meet face to face. Given the lack of own political forces that might tilt the balance, the political situation at this moment, the negotiations and the political ability of those in charge of the Executive Branch will be the elements with a say in the future of the armed forces.



**The Legal Framework and the Defence System**

**National Legislation\***

**Systems and Concepts**

- Act which establishes Rules for Exceptional Conditions in which the Armed Forces take over the Control of Internal Order (N° 24.150 – 1985/06/07. Last amendment: DL N° 749 – 1991/11/08) (1)
- Legislative Decree which establishes Rules which the Armed Forces have to be subjected to when operating in Zones not declared in State of Emergency (DL N° 738 - 1992/03/10. Last amendment: Act N° 28.222 – 2004/05/17)
- Act on the Entry of Foreign Troops (N° 27.856 - 2002/10/30)
- National Mobilization Act (N° 28.101 - 2003/11/13)
- Security System and National Defence Act (N° 28.478 - 2005/03/23)
- National Intelligence System Act (N° 28.664 - 2006/01/04)
- Act which establishes the Legal Nature, Responsibilities, Competencies and Organic Structure of the Ministry of Defence (N° 29.075 - 2007/08/01)
- Act which establishes the Rules for the Use of Force by Members of the military in the National Territory (Decree-Law N° 1.095 – 2010/09/01)

**Military Organization**

- Peruvian Army Organic Act (DL N° 437 - 1987/09/27. Last amendment: Act N° 29.417 – 2009/09/30)
- Peruvian Air Force Organic Act (DL N° 439 - 1987/09/27)
- Navy Organic Act (DL N° 438 - 1987/09/27)
- Organic Act for the Joint Command of the Armed Forces (DL N° 440 - 1987/09/27)
- Military Status Act for Officers of the Armed Forces (N° 28.359 - 2004/10/13. Last amendment: Act N° 29.406 – 2009/09/15)
- Act which creates the Fund for the Armed Forces and the National Police (N° 28.455 - 2004/12/31)
- Act on the Promotion of Officers in the Armed Forces (N° 29.108 - 2007/10/30. Last amendment: Act N° 29.404 - 2009/09/10)
- Act on the Disciplinary Regime of the Armed Forces (N° 29.131 - 2007/11/09. Last amendment: DS 014-2009 –DE- 2009/05/23)
- Military and Police Justice Law Organization and Procedures Act (N° 29.182 - 2008/01/11. Last amendment: Decree-Law N° 1.096 – 2010/09/01)
- Military Service Act (N° 29.248 - 2008/06/28)
- Military Police Penal Code (Decree-Law N° 1.094 – 2010/09/01)

(1) The Constitutional Court declared as unconstitutional paragraphs c), d) and e) of article 5 amended by Legislative Decree N° 749, and article 11; and it amended certain texts of articles 4, 5, 8 and 10 (sentence N° 0017-2003-AVTC – 2004/08/14).

\* The Legislative Decree concerning Self-Defence Committees as people's organizations to develop self-defence activities within their community (DL N° 741 – 1991/08/11) was submitted for derogation by the Congress on July 1st 2010; said derogation is expected to occur by the end of this year.

**Source:** Compilation based on the legislation above mentioned. For constitutional provisions see Chapter 1.

- Advisory and assistance functional relationship
- Command reporting line
- - - Joint planning and management relationship

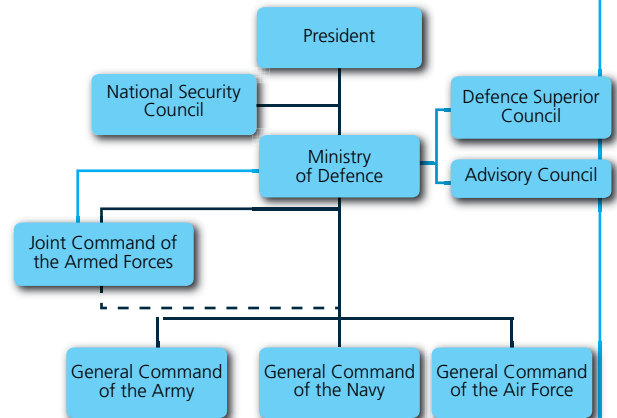

The President convenes the National Security Council, the governing body of the national defence and security system, composed of the President of the Council of Ministers, the Ministers of Foreign Affairs, Interior, Defence, Economy and Finance and Justice, the Chairman of the Joint Command of the Armed Forces and the President of the National Intelligence Council. The Ministry of Defence is the main executive body of the system and receives the advice of the Superior Defence Council, composed of the main leaders in the Ministry, the Chairman of the Joint Command and the General Commanders of the Armed Forces. The Consultative Council is a direct advisory body for the Minister. The Joint Command is the body in charge of joint military planning and employment. The Congress holds the powers granted by the Constitution and permanently monitors defence related issues through the specific committee.

**Source:** Compilation based on *Ley que establece la naturaleza jurídica, función, competencias y estructura orgánica básica del Ministerio de Defensa* (N° 29.075 - 2007/08/01) and *Ley del sistema de seguridad y defensa nacional* (N° 28.478 - 2005/03/23).

**The Budget**

Year	Defence Budget (in US\$)	Government Budget (in US\$)	GDP (in US\$)
2006	1,086,270,304	14,828,650,056	77,358,000,000
2007	1,252,580,042	19,020,674,584	101,504,000,000
2008	1,515,727,130	24,332,118,765	125,828,000,000
2009	1,600,023,237	23,645,587,544	127,368,000,000
2010	2,067,397,486	28,822,985,457	146,280,000,000

**Defence Budget (in %)**

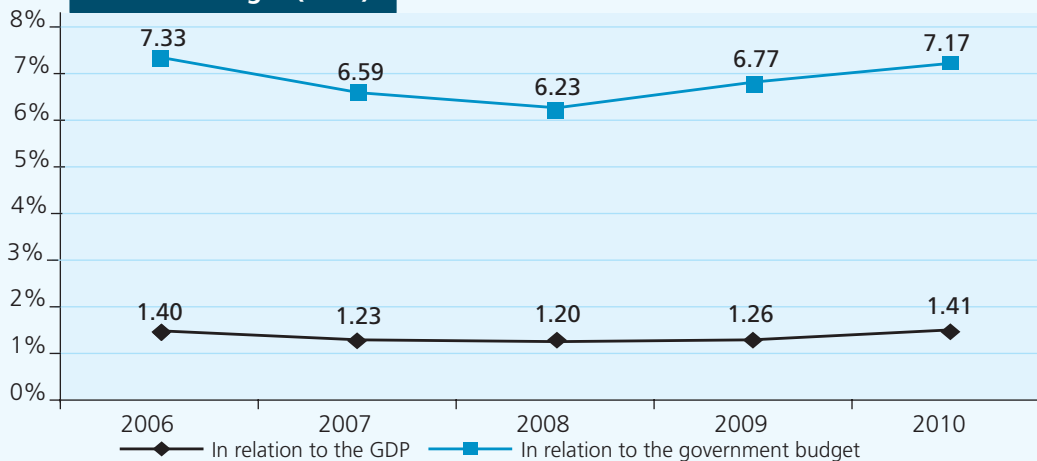

### Defence Budget Breakdown

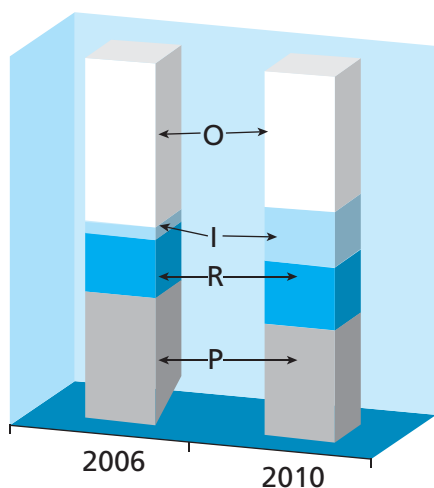

**P:** Salaries and other benefits  
**R:** Retirement and pension funds / **I:** Investment  
**O:** Other expenses

### Comparative Increase (% variation 2006-2010)

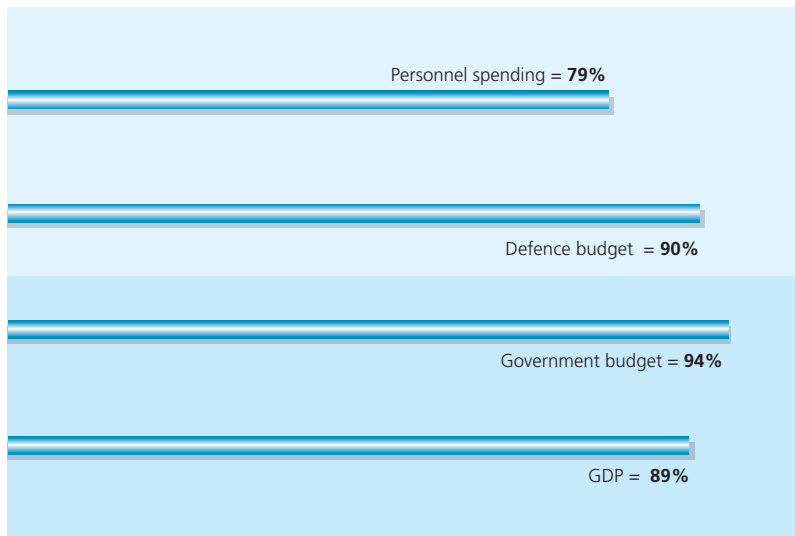

### Defence Budget 2010 (in Local Currency)

Programs	Personnel and Benefits*	Consumer Goods Services	Other Current Expenses	Capital Expenses**	TOTAL
<b>Ministry of Defence</b>	2,838,858,280	2,101,962,983	14,047,252	532,391,089	5,487,259,604
<b>Military Police Jurisdiction</b>	2,101,000	6,190,000	60,000	0	8,351,000
Subtotal	2,840,959,280	2,108,152,983	14,107,252	532,391,089	5,495,610,604
<b>Extra-budgetary</b>					
Fund for the Armed Forces					375,798,257
<b>TOTAL</b>					<b>5,871,408,861</b>

\* Includes social security obligations.  
 \*\* Includes debt services.

### Composition of Defence Budget 2010

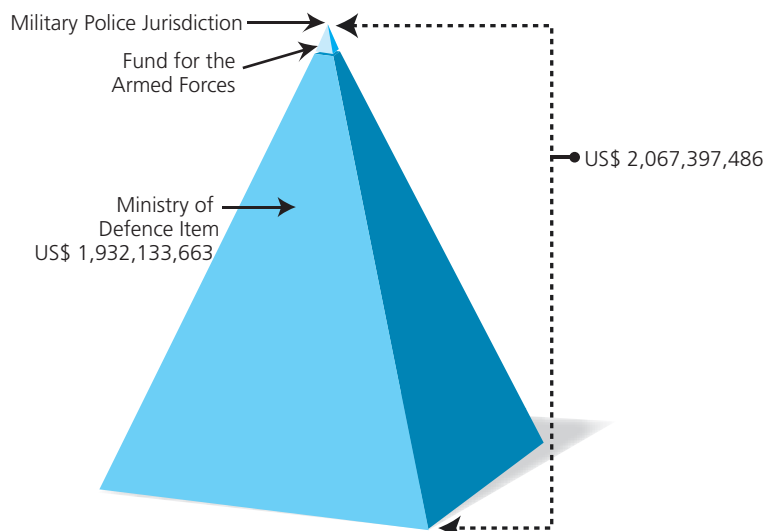

In 2010, the Ministry of Defence allocated US\$ 83,384,946 for investment in equipment. Adding the incoming resources to the Fund for that same year, which are exclusively destined to the acquisition, improvement and maintenance of Armed Forces equipment, the amount reaches US\$ 215,708,276, representing 10.43% of the budget.

**Source:** Compilation based on *Ley de presupuesto del sector público para el año fiscal 2006, 2007, 2008, 2009 and 2010*. The State Budget passed by the Congress by means of the above mentioned Act is considered herein. The concept of investment is that expressed in "Acquisition of non-financial assets" and revenues for the Fund for the Armed Forces. Extra-budgetary funds: *Ley que crea el Fondo para las Fuerzas Armadas y Policía Nacional* (N° 28.455 – 2004/12/21) and *Estadística Petrolera 2006, 2007, 2008 and 2009*, Perupetro. Acquisitions: *Cronograma de ejecución de proyectos de inversión 2010*, Ministry of Defence.

GDP: Projection of the World Economic Outlook Database, IMF, of each year under review. This source has been taken for comparative purposes. Each country prepares the budget based on its own GDP estimation.

The dollar value considered corresponds to the exchange rate determined by the World Economic Outlook Database, IMF, for each year under consideration. As of July, the 2010 exchange rate average is 2.84 Soles, based on the data provided by the Central Bank of Peru. For further calculations, figures are provided in local currency.

Expressions in Bold Type (Table) make reference to the various defence budget items, which can be found in a sector-based or institutional classification of the Budget Act.



**The Ministry of Defence**

**Responsibility:**

It is the main executor body of the national security and defence system, responsible for formulating, coordinating, implementing, executing and supervising the national defence policy in the military sphere, as well as for designing, planning and coordinating this policy in the non-military arena, in accordance with current laws in effect. (*Ley del sistema de seguridad y defensa nacional*, N° 28.478 – 2005/03/23, Sec. 18)

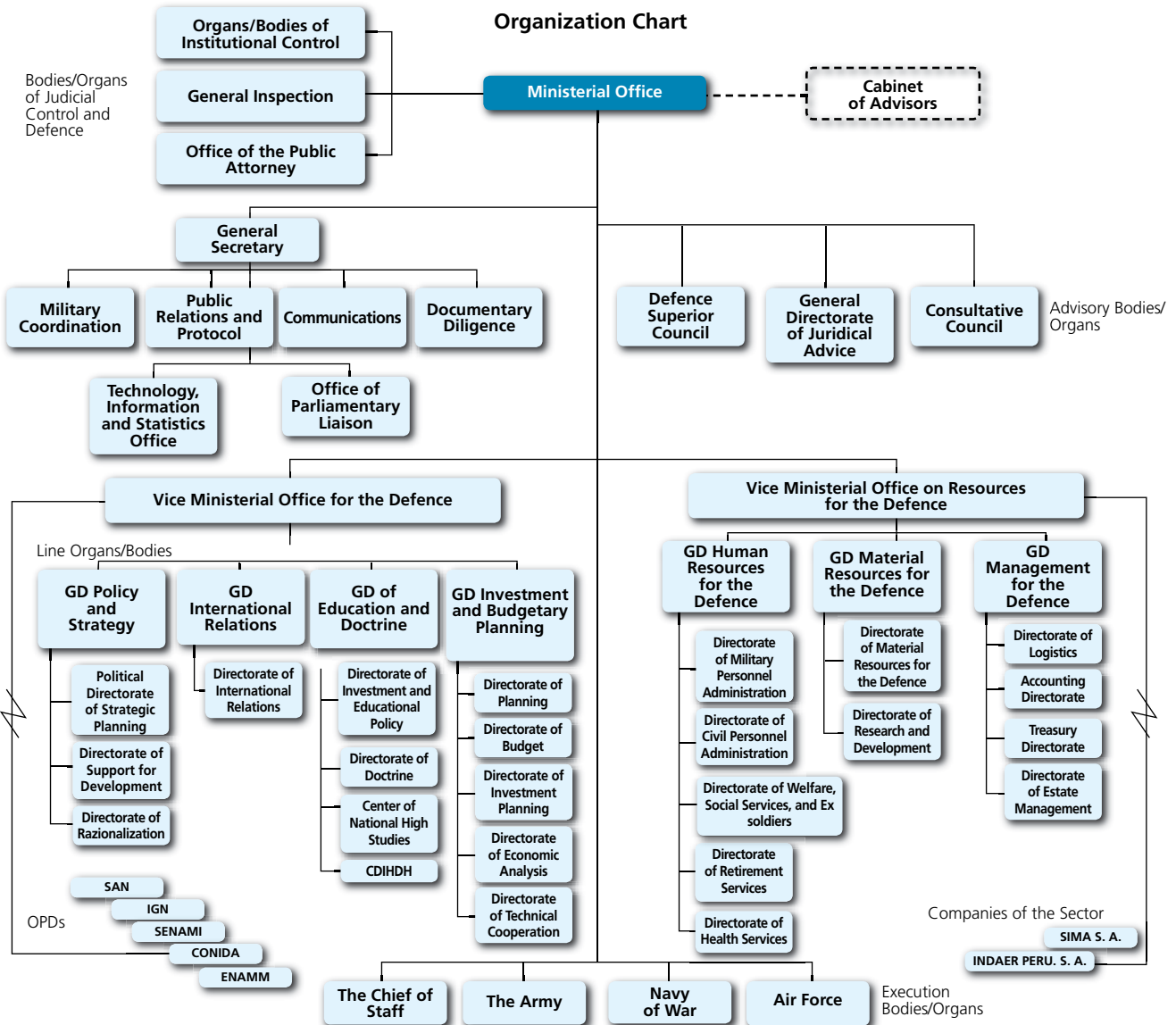

**Note:** The total number of employees is 167 (15 officers, 41 professionals, 79 technicians and 32 assistants). Data as of April 2010

<b>Date of Foundation:</b> 1987
<b>Current Minister (September 2010):</b> Jaime Fernando Thorne León
<b>Can military members be Ministers of Defence?:</b> Yes
<b>Number of military members who were Ministers of Defence:</b> 11
<b>Number of civilians who were Ministers of Defence:</b> 6
<b>Have there been any women in charge of the Ministry of Defence?:</b> No
<b>Average permanence in the Minister of Defence position:</b> 1 year and 4 months

[The Minister currently in charge is not considered. The creation date is related to the moment in which the term "Defence" becomes part of the Institution's name]

**Source:** Compilation based on information provided by the Ministry of Defence.

**Political Definitions**

**Policy Guidelines**

Within the framework of the country's policy strategic principles, one of the national purposes is to develop a democratic and decentralized State, capable of efficiently operating at the service of the people and their development, as well as ensure national security. National security policies are aimed at:

1. Ensuring full operability of the Armed Forces focused on the deterrence, defence and prevention of conflicts, including peacekeeping.
2. Promoting the teaching of national security concepts at all levels of the national education system.
3. Promoting the establishment and consolidation of "live borders" as development centres of activity.
4. Encouraging an active involvement for the protection of the Antarctica and environment, the development of the Amazon region, and national integration as a whole.
5. Optimizing the operation of the national security and defence system in order to defend Peru's permanent interests.

The Defence sector is responsible for securing national defence at the military and non-military spheres under its responsibility, contributing to national development in efforts for the strengthening of peace and international security.

**Sector Policies:**

- Strengthen the national territory's control systems in the land, air, maritime, lake and fluvial arenas.
- Redirect and manage resources for the recovery of the Armed Forces' operational capacity.
- Prioritize convergence and interoperability.
- Strengthen peace and cooperation with other countries in the region and take part in peacekeeping operations.
- Promote technological research and development for the sector.
- Strengthen the Armed Forces educational system.
- Develop special plans for the pacification and development of distressed and critical areas.
- Consolidate the sector's reform process through result-based management mechanisms, with transparency and accountability in the utilization of resources.
- Promote programs for military and civilian personnel welfare.

**General Purposes:**

- Optimize the human and material means of the Armed Forces, enhancing the deterrence capacity for national defence, and adopting measures to ensure the strengthening of bilateral and multilateral cooperation relations.
- Strengthen internal peace, consolidate State presence, and contribute to development and improvement of citizen's living conditions.
- Secure the institutional framework to achieve efficiency in the sector's public administration and enhance internal processes of the Armed Forces, thus guaranteeing their efficiency at the operational, logistic, and administrative levels.
- Implement result-based management systems that ensure the efficient, transparent and sustainable use of the sector's resources.
- Promote the sector's military and civilian personnel welfare.

**Source:** Marco Estratégico del Sector Defensa 2007-2011 and Plan Perú 2021.

Peru published the *Libro Blanco de la Defensa Nacional del Perú* (White Book of the National Defence of Peru) in 2005.

**Reports Submitted to the United Nations and the OAS**

1997	1998	1999	2000	2001	2002	2003	2004	2005	2006	2007	2008	2009
✘	✘	✘	✘	✘	✘	✘	✘				✘	
				◊	◊	◊				◊		◊
✱		✱		✱		✱						✱

Register of Conventional Arms: ✘ Register of Military Expenditures: ◊ Implementation of Confidence and Security Building Measures: ✱

**Source:** Compilation based on reports submitted to the United Nations Register of Conventional Arms and the United Nations Instrument for Reporting Military Expenditures and reports submitted to the OAS on the Implementation of Confidence and Security-Building Measures.



**Military Career**

**Commissioned Officers' Career Path<sup>1</sup>**

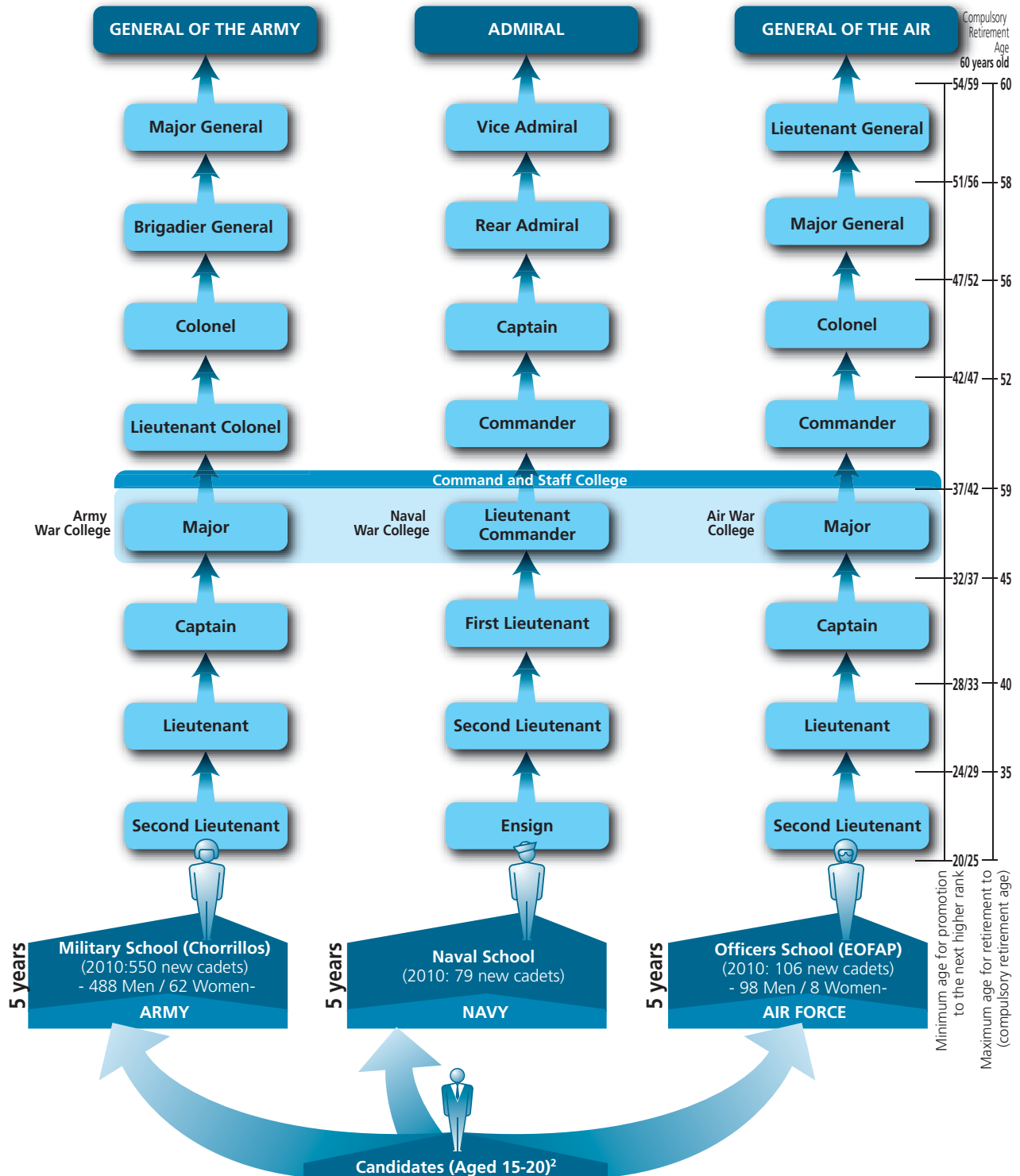

1 Command corps includes officers who have been educated at military academies from the beginning of their professional careers. The graph makes a theoretical reconstruction of officers' promotion through the completion of mandatory courses. Further requirements for promotion have not been considered.

2 Ages of 15-20 have been considered for comparative purposes. Entry age varies depending on the services. The minimum age for promotion will depend on the age of graduation from the appropriate military education institution.

Source: Compilation based on the *Ley orgánica del Ejército Peruano* (DL N° 437 - 1987/09/27. Last reform: Law N° 29.417 - 2009/09/30); *Ley orgánica de la Fuerza Aérea del Perú* (DL N° 439 - 1987/09/27); *Ley orgánica de la Marina de Guerra* (DL N° 438 - 1987/09/27); *Ley orgánica del Comando Conjunto de las Fuerzas Armadas* (DL N° 440 - 27/09/1987) and *Ley de situación militar de los oficiales de las Fuerzas Armadas* (N° 28.359 - 2004/10/13. Last amendment: Law N° 29.406 - 2009/09/15/09). New cadets: information provided by the armed forces' website.

**The Armed Forces**

**General Mission**

The Armed Forces have as fundamental mission to guarantee the independence, sovereignty and integrity of the Republic. In state of emergency, the Armed Forces take control of the internal order if the President of the Republic so requires. Participate in the economic and social development and in civil defence actions in accordance with the law. (Political Constitution, Sec. 137, sub. 1, 165 and 171)

**Specific Missions**

**Army**

The primary mission of the Army is to guarantee the independence, sovereignty and territorial integrity of the Republic, within its scope. It intervenes in states of exception in accordance with the Political Constitution of the State and participates in the social and economic development of the country and in civil defence in accordance with the law.

**Navy**

- Participate in the strategic planning of the national defence.
- Organize, equip, prepare and maintain naval forces in its maximum combat potential to ensure the defence of the Nation.
- Defend the maritime, fluvial and lacustrian assets, protecting the activities carried out there.
- Operate naval forces.
- Propose and execute the navy budget.
- Contribute to the social and economic development of the country and the civil defence in areas of competence.
- Participate in the internal defence of the territory in accordance with Section 231 of the Political Constitution of the State.

**Air Force**

The Air Force is the air branch of the Armed Forces whose primary mission is to guarantee the independence, sovereignty and integrity of the Republic's territory, in its scope of competence, for which it prepares and develops its strength; intervenes in states of exception in accordance with the Political Constitution; and participates in the social and economic development of the country and civil defence

**Total Strength: 106,034\***

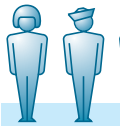

**Officers:**

M 10,465      550 W

**Non-Commissioned Officers:**

M 35,261      1,850 W

**Troops:**

M 54,340      3,568 W

M 84.38 %      5.62 % W

**Total 106,034**

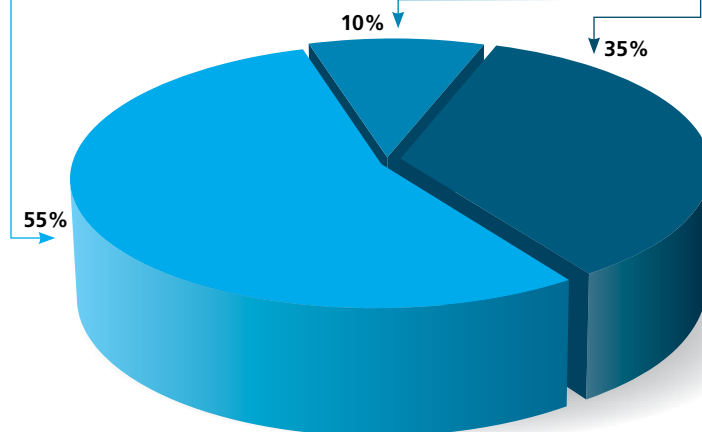

\* Data corresponding to 2009. No modification have been informed for 2010

**M:** Men / **W:** Women

**Source:** Ley Orgánica del Ejército Peruano (DL N° 437 – 1987/09/27), Ley Orgánica de la Fuerza Aérea del Perú (DL N° 439 – 1987/09/27), Ley Orgánica de la Marina de Guerra (DL N° 438 – 1987/09/27) (missions) and information provided by the Ministry of Defence (Regular Forces).





**Women in the Armed Forces**

**Women's Admission to the Armed Forces (year)**

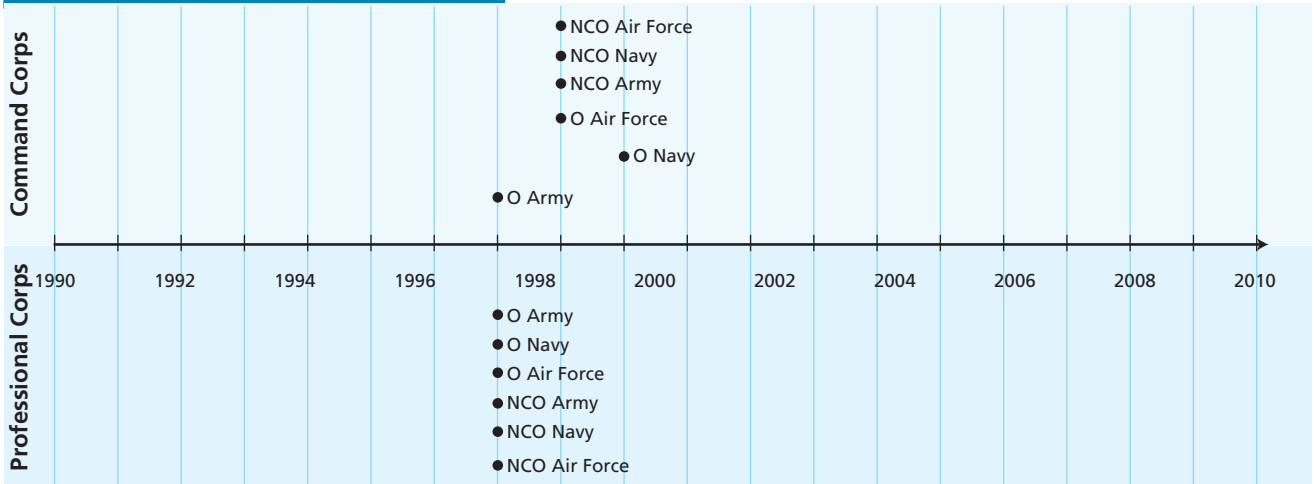

O: Officers - NCO: Non-commissioned Officers

**Note:** The Command corps includes officers who have been educated at military academies from the beginning of their professional careers. The Professional corps refers to those who develop a career in the civilian sphere and are then incorporated to the armed forces.

**Women Officers who have reached the highest rank in the Command Corps (2010)**

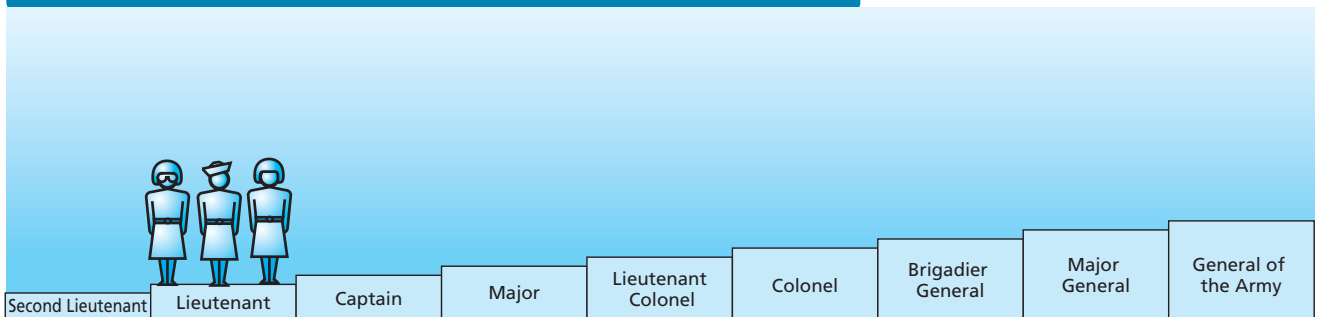

**Note:** These ranks correspond to the Army, as an example. The equivalent rank for Lieutenant in the Air Force is the same and Second Lieutenant in the Navy.

**5.62 % (5,968) of the total Armed Forces are women.\***

\* Data corresponding to 2009.

**Source:** Information provided by the Ministry of Defence and Project 07-184 Global Peace and Security Fund-RESDAL.

**Military Service**

It is voluntary for both sexes and has a duration of up to two years. The entry requirements are the following:

- Being single.
- Having completed the primary school.
- Not having criminal records.
- Passing the physical and psychological examination.

Former students and former cadets of the Police and the Armed Forces who have attended military schools for at least one year shall be exempted from the military service.

According to the Military Service Law, among other things, soldiers shall receive basic, technical and productive or higher technological education in different fields; 10 points over 100 for applicants to Armed Forces and Police schools; and 50% of the registration fee value.

**Source:** Ley del servicio militar (Nº 29.248 – 28/06/2008).

**Defence and National and International Community**

**Participation in Peace Operations**

Current Missions	Military Component			
	MEM		MC	
	Men	Women	Men	Women
MINUSTAH (Haiti)	-	-	371	1
MONUSCO (Dem. Rep. of the Congo)	5	2	-	-
UNFICYP (Cyprus)	-	-	2	-
UNMIL (Liberia)	2	-	2	-
UNMIS (Sudan)	13	-	-	-
UNOCI (Ivory Coast)	3	-	-	-

MEM: Military experts on mission, including military observers, judge advocates and military liaison officers, among others - MC: Military Contingent.

**Source:** Compilation based on documents from the Department of Peacekeeping Operations of the United Nations. Data as of 31 August 2010.

Peru contributes 401 military troops to the United Nations peacekeeping missions, which represents 5.24% of the total contribution of Latin America.

The CECOPAZ, Joint Training Centre for Peacekeeping Operations, was created on November 11, 2003. In May 2001, the CECOPAZ presented the First Female Contingent of Blue Helmets, made up of 23 female non-commissioned officers of the Air Force.



**Support Actions**

**Security in the VRAE region**

Different operations for the control of the Apurímac and Ene rivers' valley region (VRAE), declared in state of emergency, are carried out through the Joint **Command of the Armed Forces. The VRAE Special Command** is a specialized body responsible for the actions in the area. This special command has a Joint Base of the Armed Forces, made up of air, naval and ground components.

**Operations**

The control tasks in the area consist of ground, naval and air operations, which include intelligence and strategic activities performed in conjunction with the National Police. The "Mayo 2010" Operation Plan was based on the operational concept of creating a large fence in the VRAE region and keeping the area under surveillance. The "Julio 2010" Operation Plan aims at specific operations instead of conventional actions in vast sectors of the region.

**Civic Actions**

Apart from surveillance, control and direct action operations to fight against terrorism and drug trafficking, the Special Command performs several civil support actions in the VRAE community. Actions carried out during 2010 include health care in different medical specializations, legal advice, delivery of food, working tools and school stationery, as well as recreational activities in the communities of the area.

**2010 Investment Projects**

There are several investment projects for Armed Forces detachments in the VRAE region, which include the implementation of detachments, apart from the implementation and reinforcement of communication and surveillance systems.

**Amounts allocated to each institution**

Army: US\$ 128,931  
Air Force: US\$ 70,324  
Navy: US\$ 110,870

**Community Support**

Through its different institutions, the Armed Forces regularly perform civil actions, providing support to the population through service provision, with the aim of contributing to fulfilling the urgent needs of the populations under extreme poverty. The actions are carried out periodically in different areas of the national territory.

**Main activities:**

- Promotion and execution of health care and dental campaigns.
- Promotion and execution of veterinary campaigns.
- Organization of lectures on family planning, personal hygiene..
- Providing information on the Military Service Law and its rules.
- Organization of cultural, sports, religious and recreational activities.

**Outstanding activities during 2010:**

- Civil integration action. General and specialized health care, dental care, nutrition and psychology; veterinary care; legal advice and lectures on women and children rights and family violence; recreational activities and breakfasts.
- Multisector civil action. Health care, legal assistance, supply of breakfasts, food, education materials, recording of reserves, debris cleaning and removal. The activity took place at a national level with the support of several public and private institutions, benefitting more than 160,000 people across the country.
- Civil action in Huachocolpa. Supply of materials, health care and medicine distribution, benefitting over 3,000 people.

**Natural Disasters**

Activities during 2010:

Rescue and evacuation operations, distribution of materials and basic supplies, road recovery and establishment of air bridges in areas affected by rains and floods in the Cusco department. Assistance provided to almost 3,000 people and distribution of 16.5 tons of aid material.

Rescue and aid activities for the inhabitants affected by rains and river floods in the Puno region. Seventeen tons of humanitarian aid material was delivered.

Cleaning, repair, rescue, lifesaving and aid tasks were carried out for the population affected by landslides in Carhuaz and Huánuco.

"Air Bridges", including transport of medicines and basic materials, rescue tasks and aeromedical evacuations in disaster scenarios.

**Source:** Websites of the Joint Command of the Armed Forces, Army, Air Force, Navy and Ministry of Defence and *Cronograma de ejecución de proyectos de inversión 2010*, Ministry of Defence.



Analisis:

## Peru 2009-2010, The Challenges of Growth

**Ciro Alegría Varona**

*Professor of the Pontificia Universidad Católica.*

Throughout his administration, President Alan García has made sure to declare, in every possible important occasion, his position against excessive ordnance spending in the region. This does not constitute a statement of principle or ideals, but rather the result of a specific situation. Since 2002, Peru's economy has been growing year over year. With annual rates in the range of 5-10% and inflation around 2%, Peru has become a small oasis for capitals spooked by the international crisis, which provided outstanding availability of money and internal credit. However, this growth is not indicative of a growth in productivity or dignified employment levels. The current phase of infrastructure and education investments is for the long term. Therefore, sacrificing tax resources in armament would be counterproductive, since fiscal surplus and public saving are the main drivers of development.

At the beginning of the current administration, 2006-2011, spending in armament renewal was estimated in about US\$650 million for five years, a small amount compared to those invested by other countries in the region. In fact, 2009 acquisitions were in the order of US\$35 million, which was within the estimated budget. This material of Chinese origin includes rockets, night vision goggles, and vehicles for the use of the Army. Currently, a contract is in place with Russia for maintenance and equipment services for MIG 29 aircraft and helicopter acquisitions, including two combat helicopters. In 2010, Israel-made antitank missiles were acquired, a decision totally backed by the specialists. Instead of competing with Chile over who has the most modern tanks (tanks that cost about

US\$10 million each and necessarily operate in groups of several), an efficient antitank system was chosen, costing one fifth of that amount. The decision to abandon the acquisition of Chinese tanks was not due to any doubt as to weapon quality, but rather a strategic decision based on the potential scenarios in which the tanks were to be used and if such spending was actually in line with Peru's security policy.

Peru's particular financial situation also serves to explain the historical opportunity the country has had to introduce large reforms in civil-military relations in Latin America. These reforms, implemented at the beginning of Toledo's office, generated a series of Offices of Vice Ministers and General Civil Directorates, within the Ministry of Defence, which affected -for the first time and systematically- both budget cycle and military career management. With these reforms at the beginning of the current government, and with Allan Wagner as Minister, the joint command was included among the Ministry's planning and execution organizations, promotion rules were further defined, and more exhaustive administrative controls were applied, breaking the old parallelism existing between civil and military leadership. This has served to put an end to corruption scandals – including war material maintenance – which so proliferated in the past. Fluid cooperation between military commands and civilian executives has been essential in the recovery of operational capacity within the framework of the aforementioned strategic position. Women's entry to the armed and police forces, together with the changes introduced

to disciplinary regulations and budgetary improvements in the military service, have all contributed to solve the identity crisis left behind by Fujimori's decade. Pending tasks in the defence sector of Peru include the structural solution of the pension and salary issues; the organization of a connected educational system between the Armed Forces and universities; the strengthening of State presence in the territory by the appropriate use of military facilities and capabilities; an adequate legal defence for personnel prosecuted as a result of the anti-guerrilla struggles; technological advancement and preparation to further contribute to international security.

Peru's position has had certain impact on the region. Ecuador and Paraguay, which governments are more in line with the "Bolivarian-style" planning than with economic liberalism, have supported Peru's initiative. Considering that these three countries are receiving investments from Chile and Brazil, and are current or potential energy suppliers, it would be better for them to share a common position looking for a way to improve their negotiating power. Peru's stability is one of Brazil's main interests. Brazilian mines Motorantim and Vale have recently invested approximately US\$1,000 million; Electrobras is planning to build seven hydroelectric power plants in Peru; the Trans-Amazonian highway will be opened in 2010, connecting Acre with the Southern Andean region; another Trans-Amazonian highway will be open in the North; and Peru's ports will be prepared to handle future large volumes of trade between Brazil and China.

With regards to the South American Defence Council, Peru has found that Brazil's initial proposal is not clearly defined and has therefore emphasized the importance of deepening previously adopted agreements on matters such as the war against terrorism, the fight against drug trafficking, finding a peaceful solution to pending matters, showing unrestricted respect for national sovereignty, and confidence-building measures. Peru, undoubtedly, helps Unasur's objectives and, therefore, requests that further efforts be made to strengthen Unasur's foundations in a regional defence community. In South America, the realistic principle stating that a region's governing power has to function as mediator and arbiter in conflicts originated within the region before they are projected into the world's scenario is particularly true in this case. Brazil observes this fact. An example of this is Brazil's active participation in peace negotiations between Peru and Ecuador and its current commitment to Peru's economic development.

A central element of Peru's position is the search for a final solution to pending border issues with Chile. This solution should be somewhere in the line of the settlement reached with Ecuador in the Protocol of Peace, Friendship and Boundaries, signed in Rio de Janeiro

in 1998. Chile does not recognize the existence of any pending issues, since it considers that all matters have been regulated by the status quo. Peru has, therefore, formally filed a claim before the International Court of The Hague in January 2008. In August 2010, Ecuador has accepted Peru's request to clarify its non-participation as third party in this proceeding. Without changing its neutral position regarding Peru's claim, it has ratified all fishing treaties that Chile considers as border treaties.

In 2009, the Defence sector implemented a series of actions against the remnants of the terrorist group *Sendero Luminoso* (*Shining Path*), which moves along the valleys of the Apurímac and Ene (VRAE) rivers. Such small armed groups parasitize drug trafficking economy and recruit children among coca leaf growers, who submitted to these kinds of works forced by extreme poverty. In Huallaga, eradication, although extensive, has not been successful, since the aggregate number of cultivated areas has exceeded the number of the eradicated ones. However, in that same valley, crop replacement and police chasing of drug dealers have yielded some encouraging results. In the rest of the country, although drug shipments have been seized, their leaders have not been captured, with leaves their cartels practically unharmed. Drug trafficking has no relevant incidence on the Legislative Branch, political parties and media, but its incidence grows in selected regional governments. Backed by the United States, millionaire rewards have been offered for the capture of cartel leaders, including now Sendero Luminoso's leaders, who are still running their operations in Huallaga and the VRAE region.

Almost untouched by the international economic crisis, Peru was forced to face an interior security crisis in June 2009. A Police assault in a highway boycott that was being held in Bagua dramatically escalated the local violence level, leaving 29 fatal victims, most of them policemen who were held hostage by indigenous groups. This was the final outcome of a six-month controversy with Amazonian indigenous organizations which were against new decrees that favoured investing in fiscal lands, without prior consultation to their inhabitants. Instead of increasing the level of violence, the Peruvian government avoided taking measures that would continue with this confrontation escalation. These decrees were annulled. It is impossible to interpret these protest movements, as well as other local protests, as symptoms of political instability. Espionage and corruption cases (namely "Business Track" and "petroaudios,") which generated a crisis at Ministry level, cannot be interpreted either as symptoms of a relapse in political instability. They can be compared to the approximately 50 crimes committed by drug trafficking, which have led to a new type of challenge in terms of security that requires a systemic response.



# Uruguay

## The Legal Framework and the Defence System

### National Legislation

#### National Legislation

- Act on State Security and Internal Order (N° 14.068 - 1972/07/12)
- Armed Forces Organic Act (DL N° 14.157 - 1974/03/05. Last amendment: Act N° 18.198 - 2007/11/28)
- National Defence Framework Act (N° 18.650 - 2010/03/08)

#### Military Organization

- Military Retirement Service Organization Act (N° 3.739 - 1911/02/24. Last amendment: Act N° 16.320 - 1992/11/01)
- Military Codes (Decree-Law N° 10.326 - 1943/01/28)
- Organic Act of the Navy (N° 10.808 - 1946/11/08)
- Organic Act of the Air Force (N° 14.747 - 1977/12/30)
- Organic Act of the National Army (N° 15.688 - 1985/01/17)

- Advisory and assistance functional relationship
- Command reporting line
- - - Joint planning and management relationship

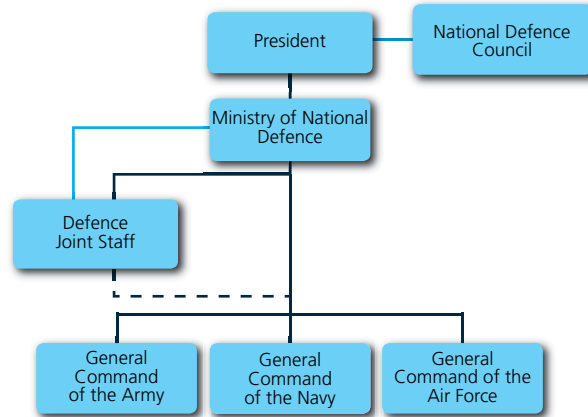

The President may receive the advice of the National Defence Council, composed of the Ministers of Defence, Interior, Foreign Affairs and Economy and Finance. The Minister of Defence leads the defence policy and holds the higher conduction and administration of the Armed Forces. The Defence Joint Staff is the military ministerial advisory body, responsible for the joint military planning and employment. The General Assembly holds the powers granted by the Constitution and permanently monitors defence related issues through the defence committees in both Houses.

**Source:** Compilation based on the legislation above mentioned. For constitutional provisions see Chapter 1.

**Source:** Compilation based on the Political Constitution, *Ley orgánica de las Fuerzas Armadas* (N° 14.157 - 1974/03/05. Last amendment: Act N° 15.808 - 1986/04/07), and *Ley marco de defensa nacional* (N° 18.650 - 2010/03/08).

## The Budget

Year	Defence Budget (in US\$)	Government Budget (in US\$)	GDP (in US\$)
2006	215,709,213	2,833,420,447	14,182,000,000
2007	290,335,815	3,829,060,623	21,171,000,000
2008	316,844,107	4,331,809,675	26,607,000,000
2009	322,261,459	4,443,159,356	31,606,000,000
2010	375,059,540	5,171,109,540	40,577,000,000

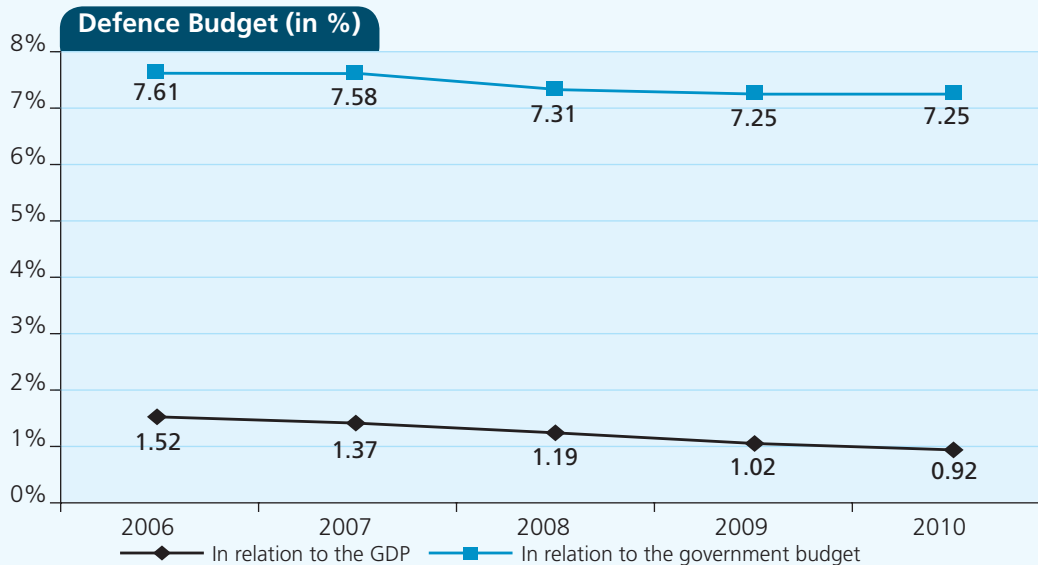

**Defence Budget Breakdown**

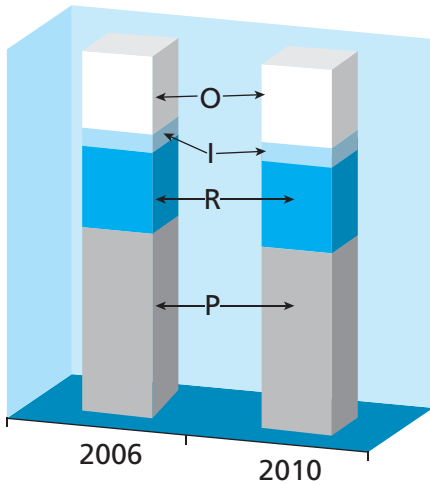

**P:** Salaries and other benefits  
**R:** Retirement and pension funds / **I:** Investment  
**O:** Other expenses

**Comparative Increase (% variation 2006-2010)**

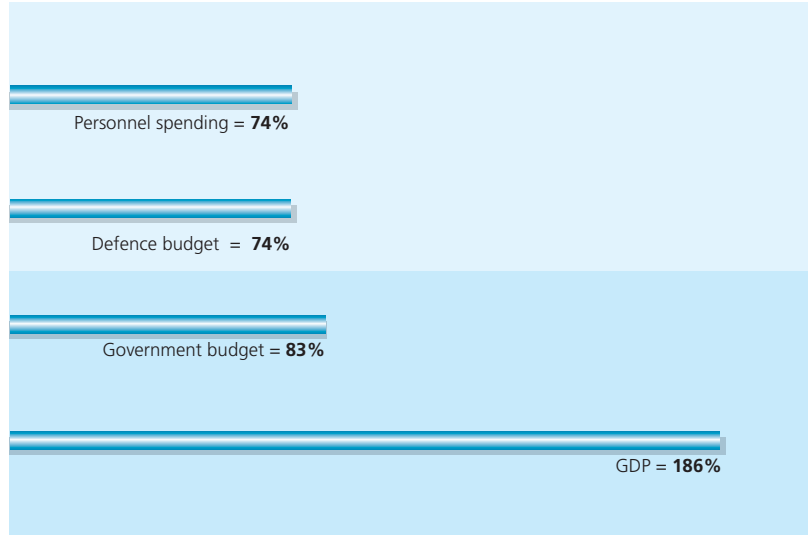

**Defence Budget 2010 (in Local Currency)**

Sections	Operations	Investment	TOTAL
<b>National Ministry of Defence</b>			
Central Administration*	688,273,000	13,221,000	701,494,000
National Army	2,134,499,000	42,038,000	2,176,537,000
National Navy	978,096,000	115,063,000	1,093,159,000
Uruguayan Air Force	589,306,000	100,860,000	690,166,000
Administration and Control of Aviation and Airports	306,298,000	103,267,000	409,565,000
Military Health	578,727,000	27,098,000	605,825,000
Military Social Security	5,727,000	4,191,000	9,918,000
Meteorological Research and Studies	45,264,000	460,000	45,724,000
Reduction of Non Priority Tasks	177,000	0	177,000
Reduction of Non Priority Tasks	185,000	0	185,000
<b>Financial Transferences of the Social Security Sector</b>			0
Financial Aid to the Military Fund	1,775,942,000	0	1,775,942,000
<b>TOTAL</b>	<b>7,102,494,000</b>	<b>406,198,000</b>	<b>7,508,692,000</b>

\* Act Nº 18.369 for budgetary changes, establishes an incremental cost of \$245,203,000 for operational expenses and \$6,850,000 for investment expenditures of the Ministry of Defence. Uruguay has a multi-annual budgeting process.

**Composition of Defence Budget 2010**

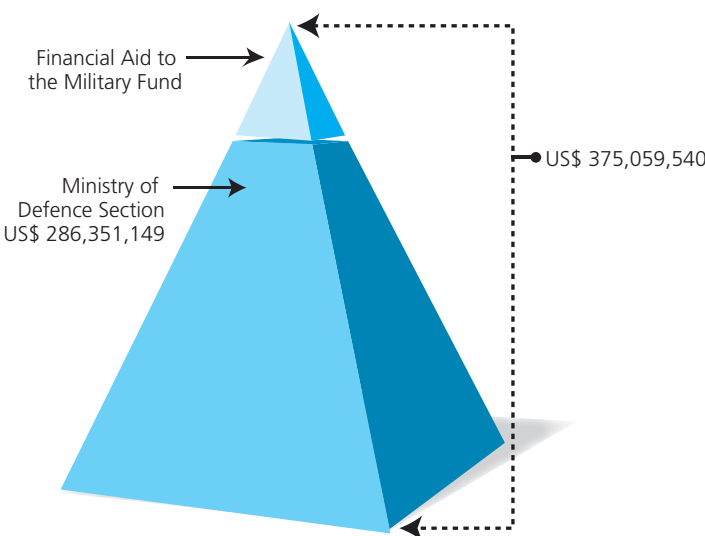

Between 2007 and 2009, military acquisition contracts signed with member countries of the European Union (Germany, Austria, Spain, France, The Netherlands, United Kingdom, Czech Republic, and Switzerland) amounted to US\$19,522,813, and US\$12,415,233 with the United States. Such amounts represent 3.44% of the allocated defence budget for those years.

**Source:** Compilation based on *Ley de presupuesto nacional, periodo de Gobierno 2005-2009* and *Ley de modificaciones presupuestales, periodo de Gobierno 2007-2009 and 2008-2009*. As of the closing of this edition, the budget law for the 2010-2014 period was still under discussion at the Senate. The 2009 budget is currently effective for 2010, as provided for in the Constitution. Differences in figures for such years are due to changes in the dollar exchange rate. The State Budget passed by the Congress by means of the above mentioned Act is considered herein. The concept of investment is that expressed in "Investment". Acquisitions: reports submitted by the member States in accordance with the Common Position 2008/944/PESC of the European Union Council (reports issued as of October, 2010) and Just the Facts (Center for International Policy, Latin American Working Group Education Fund and Washington Office on Latin America).  
 GDP: Projection of the World Economic Outlook Database, IMF, of each year under review. This source has been taken for comparative purposes. Each country prepares the budget based on its own GDP estimation. The dollar value considered corresponds to the exchange rate determined by the World Economic Outlook Database, IMF, for each year under consideration. As of July, the 2010 exchange rate average is 19.87 Pesos, based on the data provided by the Central Bank of Uruguay. For further calculations, figures are provided in local currency.  
 Expressions in Bold Type (Table) make reference to the various defence budget items, which can be found in a sector-based or institutional classification of the Budget Act.



**The Ministry of National Defence**

**Responsibility:**

It has the power and competence over the political conduct of national defence areas determined by the laws and the Executive Branch within the framework of their powers, in particular, of all matters related to the Armed Forces. It exercises the command and supervision of all activities carried out by the Armed Forces. (*Ley marco de defensa nacional*, N° 18.650 – 2010/03/08, Sec. 14 and 15)

**Organization Chart**

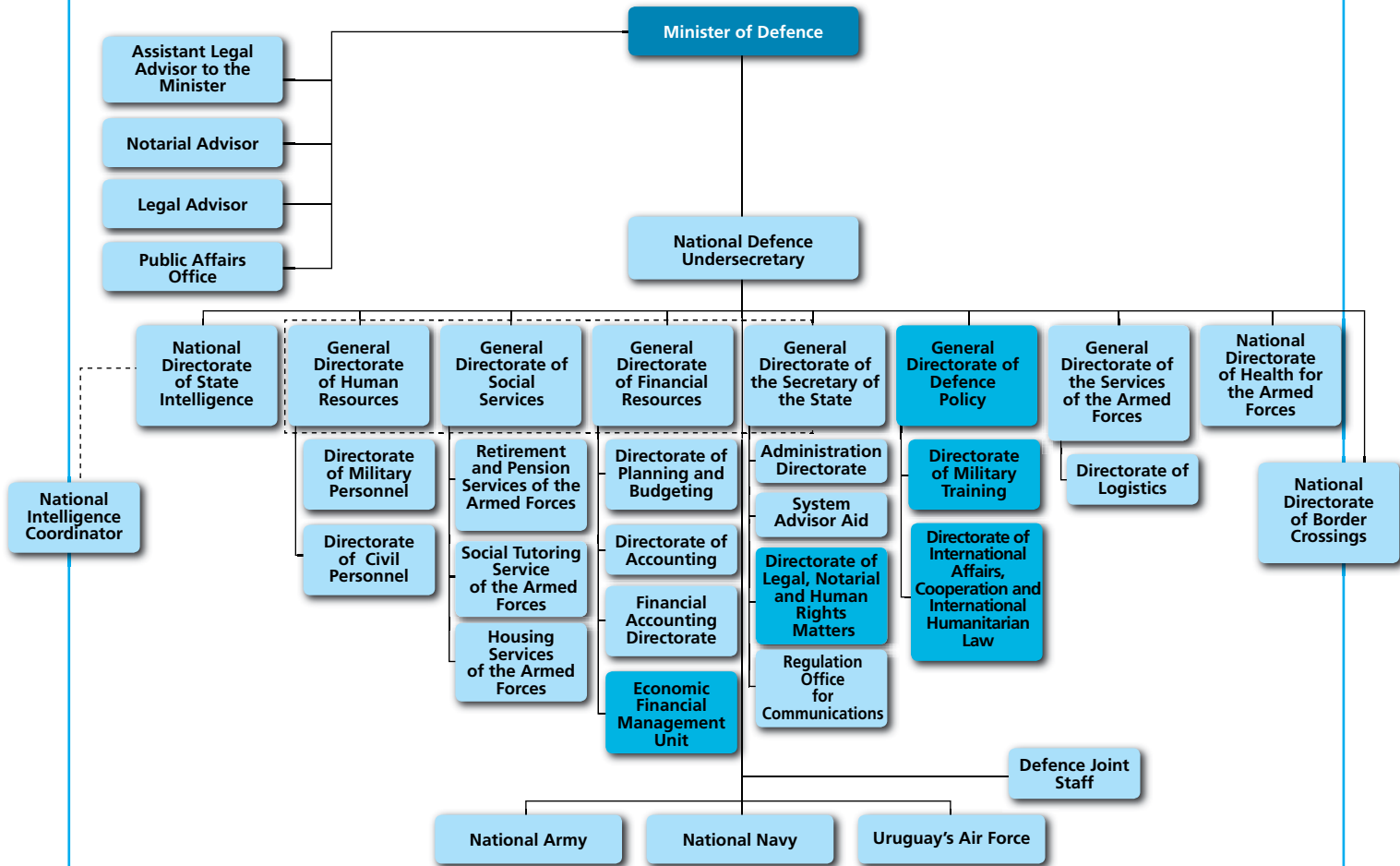

Titles established in the 2010-2014 national budget, still subject to approval

Source: Compilation based on *Ley marco de defensa nacional* (N° 18.650- 2010/02/19) and *Proyecto de ley de presupuesto nacional, periodo de Gobierno 2010-2014*.

<b>Date of Foundation:</b> 1935
<b>Current Minister (September 2010):</b> Luis Rosadilla
<b>Can military members be Ministers of Defence?:</b> Yes (if they have retired)
<b>Number of military members who were Ministers of Defence:</b> 15
<b>Number of civilians who were Ministers of Defence:</b> 22
<b>Have there been any women in charge of the Ministry of Defence?:</b> Yes (Azucena Berruti, 2005-2008)
<b>Average permanence in the Minister of Defence position:</b> 2 years

[The Minister currently in charge is not considered. The creation date is related to the moment in which the term "Defence" becomes part of the Institution's name]

Source: Compilation based on information provided by the Ministry of National Defence.

**Political Definitions**

**Policy Guidelines**

Maintain a sustainable and effective deterrence power, based on the development and sustainment of defence-oriented capabilities

**Strategic Objectives**

**National Army**

1. Sustainable and effective deterrence: systems upgrading, conventional military capability, command leadership training, military personnel's social welfare, simulation systems, distance education, military industry development, survival capacity, basic universal training, resistance operations.
2. Support internal order.
3. Support foreign policy: involvement in peace operations, military attachés, presence in the Antarctica, and participation in international forums and conferences.
4. Community support: environmental protection, disaster response assistance.

**National Navy**

1. Ready naval forces and units. Attain the best level of readiness possible for the execution of actions imposed under the Navy's mission by increasing human and material efficiency and effectiveness, as well as operational training.
2. Control territorial waters. Deter crimes in territorial waters, including any actions against national interests, enhancing surveillance and appropriate response levels with surface, air and land means available, operating with the support of sensors and naval intelligence.
3. Safety of navigation. Minimize the loss of lives and accidents at sea during navigation in jurisdictional waters and waters of interest to the Nation, in accordance with international agreements and standards, fully utilizing the navigation aid system, shipping control system, sea search and rescue system, hydrographic services, notice to the mariners and sea meteorological services and national piloting management.
4. Maritime security. Provide greater security on board national flag vessels and ships as well as foreign flag ships, when appropriate.
5. Public security within its jurisdictional area. Deter crimes against life, physical integrity and property, including the threat of terrorist actions, by optimizing surveillance and police investigation, naval intelligence and security measures on vessels, ships, beaches, coasts, islands, international bridges, hydroelectric dams, and port facilities.
6. Protection of marine environment. Deter pollution from vessels and ships in waters under the national jurisdiction, as well as neutralize adverse the effects of marine pollution accidents that may occur, through the regulation and application of marine environment protection standards and the enhancement of the National Pollutant Spill Control System.
7. Contribution to international peace. Participate in peace missions under the UN mandate, through the deployment of military observers, contingents and/or units.
8. Contribution to the national presence in Antarctica. Support Uruguay's Antarctic Institute through the provision of personnel and sea resupply for Antarctic facilities and scientific research projects, particularly those conducted in the sea.
9. Contribution to the people's welfare and security outside the jurisdictional area. Support pertinent national and municipal authorities by providing available human and material resources.
10. Conduct applied scientific research and development. Deepen scientific knowledge in its area of competence, through research project development.
11. Strategic maritime transport. Ensure a minimum critical cargo transport capacity for the country's State through the operation of proper vessels by the Navy.
12. People's maritime awareness. Importance of the sea and popular support to maritime activities, through public information campaigns, contribution with specific knowledge to the educational system, promotion of nautical activities and preservation of historical maritime and river heritage.

**Air Force**

1. Strengthen national airspace surveillance capacity.
2. Promote actions to increase air activity and infrastructure safety and security.
3. Strengthen the Air Force capability to respond to community support activities and national development.
4. Promote continuous improvement of human resource management processes, and standard of living, in order to increase their training level and contribute to the social development of Air Force members.
5. Support and contribute to the development of the national airspace strategy.
6. Take part in peace missions and support the country's presence in the Antarctic Contingent as part of the State policy, contributing to enhancing the country's international reputation.

Uruguay published the *Bases para una Política de Defensa Nacional* (Basis for a National Defence Policy) in 1999.

**Source:** *Informe y Memoria Anual de la gestión del Gobierno Nacional correspondiente al quinto periodo ordinario de la XLVI Legislatura* (2009, Annex, Ministry of National Defence) and *Proyecto de ley de presupuesto nacional, periodo de Gobierno 2010-2014*.

**Reports Submitted to the United Nations and the OAS**

1997	1998	1999	2000	2001	2002	2003	2004	2005	2006	2007	2008	2009
	✘	✘	✘	✘	✘							
		◇		◇	◇	◇						
●							●					●

Register of Conventional Arms: ✘ Register of Military Expenditures: ◇ Implementation of Confidence and Security Building Measures: ●

**Source:** Compilation based on reports submitted to the United Nations Register of Conventional Arms and the United Nations Instrument for Reporting Military Expenditures and reports submitted to the OAS on the Implementation of Confidence and Security-Building Measures.





**Military Career**

**Commissioned Officers' Career Path<sup>1</sup>**

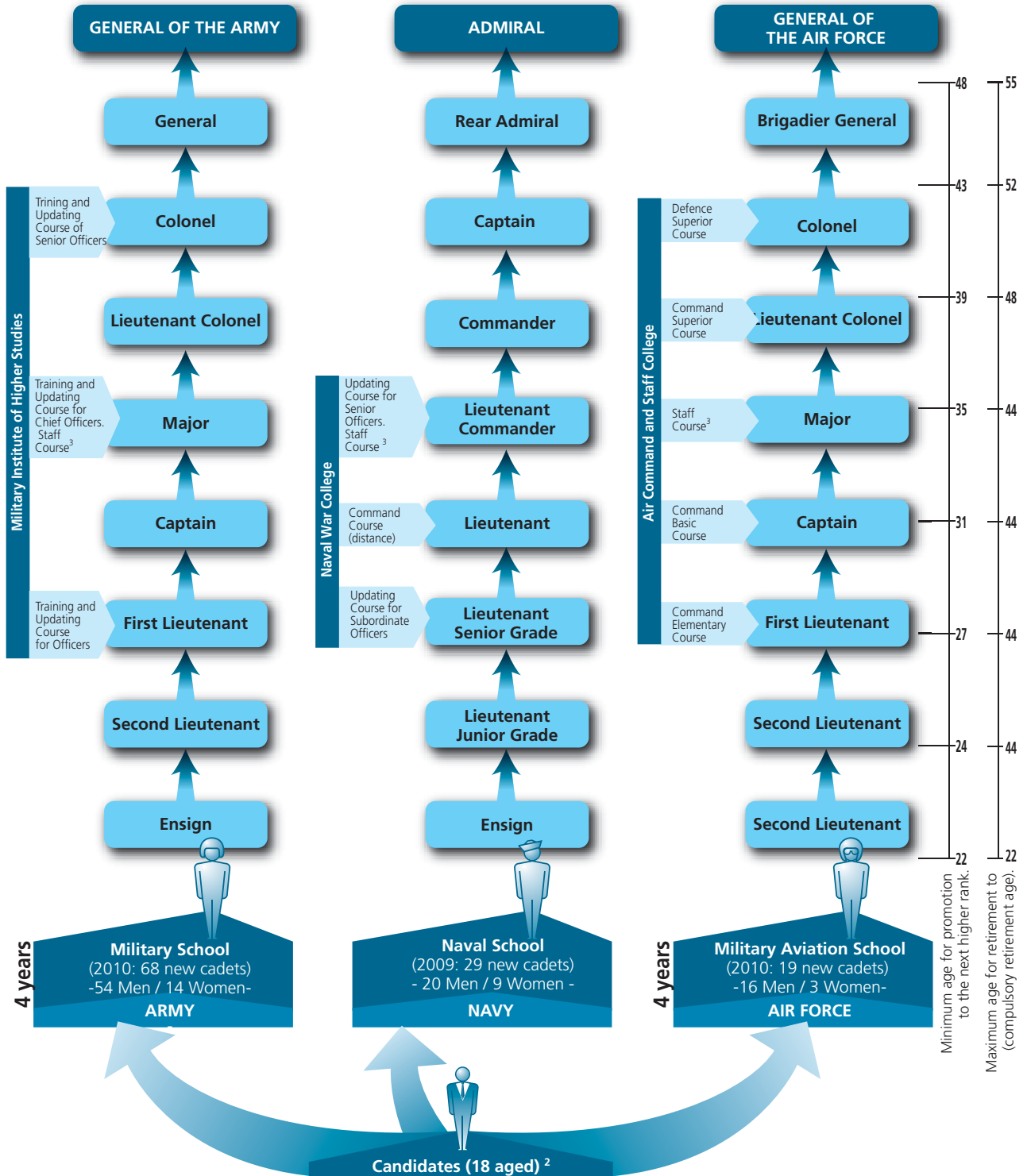

<sup>1</sup> Command corps includes officers who have been educated at military academies from the beginning of their professional careers. The graph makes a theoretical reconstruction of officers' promotion through the completion of mandatory courses. Further requirements for promotion have not been considered.

<sup>2</sup> The age of 18 years has been considered for comparative purposes. Entry age varies depending on the service: in the Army up to 24 years old, in the Naval Force up to 21 years old and in the Air Force up to 22 years of age. The minimum age for promotion will depend on the age of graduation from the military institution.

<sup>3</sup> The Staff Course in the Uruguayan Armed Forces is not compulsory. It is an optional course.

**Source:** Compilation based on Ley orgánica de las Fuerzas Armadas (DL N° 14.157 - 1974/03/05. Last amendment: Act N° 18.198 - 28/11/2007), Ley orgánica de la Marina (N° 10.808 - 1946/11/08), Ley orgánica de la Fuerza Aérea (N° 14.747 - 1977/12/30) and Ley orgánica del Ejército Nacional (N° 15.688 - 1985/01/17). New cadets: information provided by the National Army, the National Navy and the Uruguayan Air Force.

**The Armed Forces**

**General Mission**

The Armed Forces are the organized, equipped and trained arm responsible for executing military actions imposed by the national defence. Its fundamental mission is to defend the national sovereignty, independence and territorial integrity, as well as to protect strategic resources of the country, as directed by the Executive Branch, while contributing to preserving peace in the Republic under the framework of the Constitution and laws in place.  
(*Ley marco de la defensa nacional*, N° 18.650 – 2010/03/08, Sec. 18)

**Specific Missions**

**Army**

Its mission is to contribute to internal and external national security, in the framework of the Armed Forces mission, developing its capacity in accordance with specific needs foreseen. Without detriment to their primary mission, the National Army shall support and undertake development plans assigned to it for the conduct of public work.

**Navy**

Their essential mission is to defend the territorial integrity of the State, its honour and independence, peace, the Constitution and its laws.

**Air Force**

The primary mission of the Air Force is to provide internal and external security, in coordination with the other branches of the Armed Forces. Without detriment to its fundamental mission, the Air Force shall support and undertake development plans assigned to it, carrying out public work; develop its potential in accordance with the specific demands or needs for the fulfilment of its fundamental mission and other missions assigned to it; become the essential consulting body of the Executive Branch in relation to airspace policies of the Republic; and act as the executive body of the Executive Branch regarding measures of conduct, integration and development of the national airspace potential.

**Total Strength: 24,506**

Army		Navy		Air Force	
<b>Officers:</b>		<b>Officers:</b>		<b>Officers:</b>	
M 1,482	105 W	M 696	14 W	M 433	55 W
<b>Non-commissioned Officers:</b>		<b>Non-commissioned Officers:</b>		<b>Non-commissioned Officers:</b>	
M 1,745	198 W	M 361	47 W	M 237	20 W
<b>Troops:</b>		<b>Troops:</b>		<b>Troops:</b>	
M 10,692	1,887 W	M 3,189	1,098 W	M 1,726	521 W
M 86.40 %	13.60 % W	M 78.55 %	21.45 % W	M 80.08 %	19.92 % W
<b>Total 16,109</b>		<b>Total 5,405</b>		<b>Total 2,992</b>	

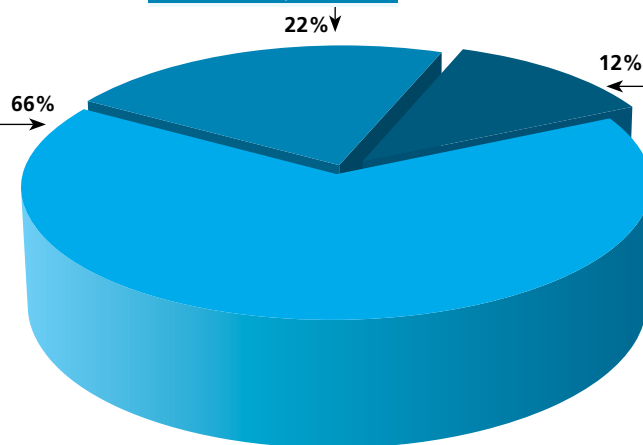

M: Men / W: Women

Source: *Ley orgánica del Ejército Nacional* (N° 15.688 - 1985/01/17), *Ley orgánica de la Marina* (N° 10.808 - 1946/11/08) and *Ley orgánica de la Fuerza Aérea* (N° 14.747 - 1977/12/30) (missions) and information provided by the National Army, the National Navy and the Air Force (regular force).



**Women in the Armed Forces**

**Women's Admission to the Armed Forces (year)**

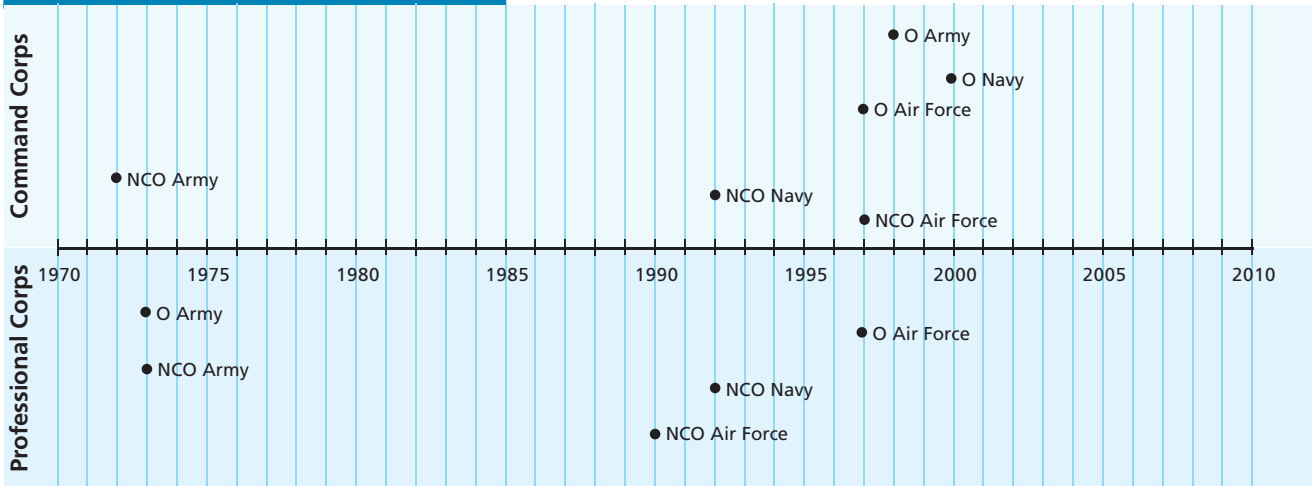

O: Officers - NCO: Non-commissioned Officers

**Note:** The Navy has no enlisted professionals; therefore, there are no women officers in the professional corps. The Command corps includes officers who have been educated at military academies from the beginning of their professional careers. The Professional corps refers to those who develop a career in the civilian sphere and are then incorporated to the armed forces.

**Women Officers who have reached the highest rank in the Command Corps (2010)**

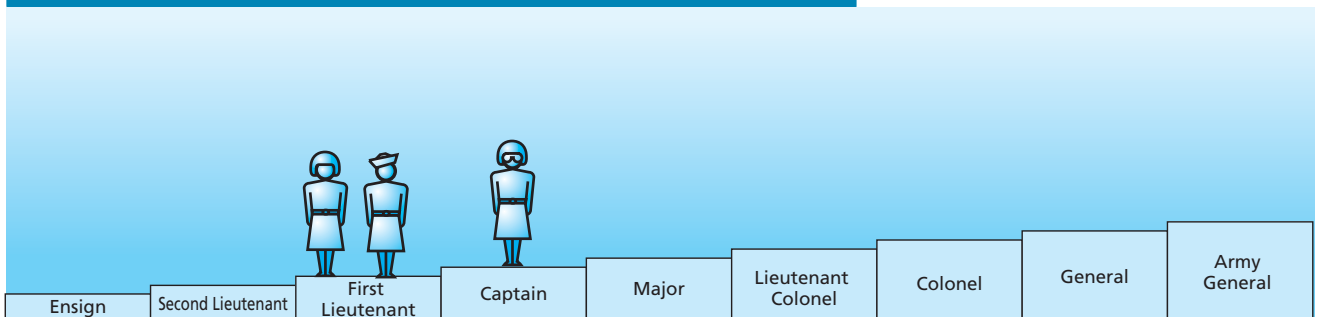

**Note:** These ranks correspond to the Army, as an example. The equivalent rank for First Lieutenant is Lieutenant Senior Grade in the Navy and Captain is the same in the Air Force.

**Source:** Information provided by the National Army, the National Navy, the Air Force and Project 07-184 Global Peace and Security Fund-Resdal.

**16.09% (3,945) of the total Armed Forces are women**

**Military Service**

It is voluntary for all men and women who have completed their primary school education. Service starts with two years as trainee. Upon completion of that period, there is the option of extending the contract for a minimum one-year period, until the person reaches the maximum age for a soldier (30 years), or entering a training school, as junior grade officer, to continue with the military career.

Year	Army Number of Enlisted Soldiers		
	Men	Women	Total
2009	830	104	934
2010	1,555	221	1,776

**Source:** Information provided by the National Army and *Ley orgánica de las Fuerzas Armadas* (DL N° 14.157 – 1974/03/05. Last amendment: Act N°18.198 – 2007/11/28).

## Defence and National and International Community

### Participation in Peace Operations

Current Missions	Military Component			
	MEM		MC	
	Men	Women	Men	Women
MINURSO (Western Sahara)	1	-	-	-
MINUSTAH (Haiti)	-	-	1,086	42
MONUSCO (Dem. Rep. of the Congo)	45	-	1,289	76
UNAMA (Afghanistan)	1	-	-	-
UNMIN (Nepal)	2	-	-	-
UNMOGIP (India and Pakistan)	2	-	-	-
UNOCI (Ivory Coast)	2	-	-	-

Uruguay's National Peacekeeping Operations Training Centre, ENOPU, was created in August 28, 2008. The Police Forces Instruction and Training Centre for Peacekeeping Operations (CICAME) was founded in January 1, 1996.

In 2009, ENOPU trained 317 military officers on peacekeeping operations to be the trainers of the forces that were to be deployed under their command. CICAME, on the other hand, trained 88 police officers.

MEM: Military experts on mission, including military observers, judge advocates and military liaison officers, among others - MC: Military Contingent.

Uruguay contributes 2,546 military troops to the United Nations peacekeeping missions, which represents 33.29% of the total contribution of Latin America.



- Uruguay ranks first in the world in the number of troops deployed, as compared to the country's population.
- It ranks tenth in the world for its contribution in number of persons.

### Historic Participation in Peacekeeping Missions

Continent	Period	Accomplished Missions	Number of Countries
Africa	1960-2006	17	13
America	1965-2000	8	7
Asia	1962-2005	9	6
Middle East	1956-2003	6	7
<b>TOTAL</b>	1956-2006	40	33

### Multinational Peace Force and Observers (MFO)

Since 1982, Uruguay has been part of the MFO in Sinai. This mission is independent from the United Nations, as it was created as a result of the Peace Treaty signed between Egypt and Israel in 1979. It makes up the Special Contingent of Transport and Engineers (AET), composed of a total 58 men.

**Source:** Websites of the Multinational Force and Observer and the National Army and documents from the Department of Peacekeeping Operations of the United Nations. Data as of 31 August 2010.

## Support Actions

### Drinking Water Treatment Plants

Based on a joint technological development project, carried out by the National Army and the State Sanitation Works Office (OSE), as from 1994, the country has a Self-Standing Water Treatment Plant (JPA). Currently, there are 55 installed and operating water treatment plants in different parts of the country. Other Iberoamerican countries, victims of natural disasters, have requested to have these plants installed as well, pursuant to the Government-to-Government humanitarian assistance modality. Nowadays, there are 6 operating plants in the Democratic Republic of Congo and 4 in Haiti, where Uruguayan troops have been deployed for the United Nations Mission.

The Army's community support purposes involve: contributing to the preservation of the environment; performing or supporting community actions (health-, education-, food-, information- and recreation-related activities, in national parks, public works); civil defence and protection operations within the framework of national emergency systems.

#### Environment

Administration, conservation, operation, and improvement of national parks and protected areas under the Force's custody. Cleaning and reforestation activities, in addition to campaigns aimed at promoting environmental preservation.

#### Community Action

**Interinstitutional Cooperation Master Agreement:** in 2009, the Ministry of Defence subscribed the Master Agreement with the Central Board Council of the National Administration of Public Education (ANEP), for the purpose of applying teaching policies among the parties and refurbishing or maintaining local teaching facilities.

**Equestrian Rehabilitation:** regular programme targeted to children with disabilities of 14 associations and schools from all over the country. They participate in the 6 military units programme and the Army's Equestrian School.

#### Emergency Operations

Assistance and rescue in case of flood and other emergencies. Support to preventive tasks being performed by the Ministry of Public Health to stop Dengue.

### Community Assistance Tasks Figures –Army 2010-

Educational centres: .....	429
Town halls, local boards: .....	121
Police, Firefighters: .....	38
National Food Institute: .....	6
Public companies: .....	11
Hospitals: .....	74
Social organizations: .....	585
<b>Total assistance works: .....</b>	<b>1,264</b>
<b>Personnel involved: .....</b>	<b>4,081</b>

### National Navy

The Navy is responsible for performing several community-related activities, the most important of which are, to name a few:

**“Uruguay Marítimo”** Project (2010): this project is aimed at familiarizing young people with the sea, port activities in general, the importance of protected areas and the protection of the environment, so as to promote awareness of Maritime and Natural Uruguay. These activities are performed together with various schools of the country.

**“Costas e Islas de Montevideo”** Project (2010): together with the Technical Team of Environmental Education of the Municipal Intendency of Montevideo, the project seeks to create interest in children and young people regarding coast recognition, and historical, ecological and management factors.

**Source:** Compilation based on information provided by the National Army and National Navy.



## Analysis:

# The *Frente Amplio* in Government and the Military Situation After five years, the most complex challenges arrive.

## Julián González Guyer

Coordinator of the Research Program on Regional Security, Armed Forces, Policy and Society (PRISEAS). ICP, FCS/Universidad de la República.

The end of 2009 brought also the end of the first—and successful—left-wing government in the history of Uruguay. From 2010 to 2014, a greater challenge will result from the election of Jose Mujica, a leader of the Tupamaro movement of the late '60s and early '70s, as the second President of the so-called *left-wing cycle* in the contemporary political history of Uruguay.

In the sphere of civil-military relations, Uruguay could be said to have successfully completed a tour-de-force under the first *Frente Amplio* administration: the armed forces orderly submitted to the ascent to government of its once internal enemy. This change has been even less dramatic than the one in 1959, when the National Party (White) came into office after over 50 years of Colorado Party hegemony. The first left-wing government in Uruguayan history showed good leadership abilities and fully exercised its constitutional powers over military institutions. The reform stage, however, will only start during Mujica's Presidency.

The balance of the *military situation* management after the first left-wing administration could be summarized saying that President Vazquez cleared the field and paved the way right up to the boundaries of what his pragmatic approach allowed.

Two events stand out in this scenario. The first one, virtually the *combination key* to the future military agenda, is the approval, by the end of the period, of the National Defence Act, with an unanimous vote of all the parties. The second was the unprecedented rigorous application by President Vazquez of Article 4 of the State's Punishment Requirement Expiration Act and

its result: the incarceration of military and civil perpetrators of human right violations during the 1973-1984 dictatorial periods. With this action, President Vazquez pointed to the target of the so-called *historical agenda*, but, nonetheless, little progress has been made towards uncovering missing people's fate.

This has brought a clearer outlook to the second *Frente Amplio* government. Though the challenge is complex, it appears less dramatic.

While the *Frente Amplio* came into office in 2005 with a *radical* proposal for the Ministry of National Defence, President Vazquez's governmental actions in the field had a markedly *incremental* character. Except for the strong drive initially given to the investigations on missing people's fate during the dictatorship—which were frozen over the second half of the period—and despite prior expectations, President Vazquez's government exhibited an overall continuity of the preceding administrations post-dictatorship.

Indeed, three distinctive features can be identified regarding defence policies over the past 25 years: a remarkable military independence in the elaboration and management of military policies, a persistent undercutting of budgetary resources allocated to the Ministry of Defence,<sup>1</sup> and an intensive use of the President's constitutional powers for the appointment of the high-

1 In 1985, by the end of the dictatorship, the Ministry of Defence was allotted 14% of public spending. By the end of 2009, the national defence budget is just below 6%. And it should be noted that a significant portion of this is not strictly military spending.

est-rank positions in the armed forces.<sup>2</sup>

On the other hand, the government did not introduce changes to the strong military involvement in UN peacekeeping missions started through the deployment of some 800 troops in Cambodia in 1992. Moreover, the number of troops deployed abroad was even increased, mainly owing to the expansion of the Uruguayan units contributed to the Minustah (Haiti). As a matter of fact, the reduction of the number of troops in MONUC (Congo) –from 1,750 to 1,360 soldiers— was accompanied by the duplication of Uruguayan military strength contributed to the Minustah. Indeed, the 585 troops deployed to Haiti at the beginning of Dr. Vázquez's administration rose to 1,136, with the Navy, and the Air Force increasing their commitment to the mission.

It should be noted that its contribution to peacekeeping missions places Uruguay among the top strength contributors to the UN, and makes it the country that deploys the largest number of military officers to peacekeeping missions in relation to its population. For about ten years now, Uruguay has maintained 10% of its military strength in UN peacekeeping operations.

The approval of the National Defence Act, which was the government's most relevant strategic achievement in the defence area, materialized in the last few days before the end of its term. Its successor is receiving a legal text without precedents in Uruguayan legislation, setting the foundations to overcome –given the necessary political will– the already century-old political weakness of the Ministry of National Defence. In this direction, this piece of legislation might be the basis for the Uruguayan civil-military relation re-definition process.

Next to the task of implementing this Act, the second great legacy President Mujica is receiving is the de-dramatization of the items on the *historical agenda* through the *de facto* assumption by the Judiciary of its powers to judge the state terrorism crimes.

The Defence Act itself poses a number of issues. The complexity of the challenge arises from the close interrelation among the various reforms and activities that are called for in the pursuit of national defence area modernization. The following list of the subjects that are still awaiting resolution will give an idea of the size of the problems to be addressed:

- Creation and implementation of the National Defence Council and elaboration of a national defence policy providing the military instrument with guidelines on orientation, priorities and needs.

- Design of a military defence strategy for both, times of peace and times of war.<sup>3</sup>

- Preparation of the Ministry of Defence Organic Act and amendment of the Armed Forces Organic Act, including the harmonization of the Organic Acts for each one of the three Forces.

- Creation of the Defence Joint Staff, already undertaken by September 2010.

- Reform of military career plans and military retirement and pension systems.

- Review of the military education systems, including the changes required by the doctrine for joint operations.

- Reformation of military justice towards its incorporation into the judiciary system, including the revision of its Codes.

All of the above calls for the redesigning of the Ministry of National Defence in order to adapt its organic structures to the roles assigned under the Act: being the government agency in charge of defence policy conduct and, more specifically, the conduct of the armed forces. However, insufficient development of the skills required for this task in the civilian sphere will demand the establishment of mechanisms to educate human resource abilities to this end.

On the other hand, a new intelligence bill has to be prepared to institute the Ministry of National Defence as the core actor since, for historical reasons, the National State Intelligence Directorate lies under its jurisdiction. The design of a non-existent national intelligence system calls for the involvement of other State agencies (Ministries of the Homeland, of Foreign Affairs, of Economy –Customs–, the Central Bank, the Anti-Drug and Anti-Money Laundering Secretariats, and so on) and of the civil society itself in the elaboration of regulations of this nature, in addition, obviously, to the Congress.

Furthermore, the current situation of the armed forces health service, which has become a welfare organization for the military family, will have to be addressed within the framework of the new national health system, while strengthening military health *stricto-sensu*.

As it follows from the foregoing, the challenges facing the new Minister of the National Defence, Luis Rosadilla and his team are huge. Their resolution will, surely, exceed the possibilities of a five-year term.

2 Dr. Vázquez's administration put an end to the last prerogatives that the Army still kept for the appointment of Generals.

3 It requires definitions on foreign policy, the country's strategic stance and required Armed Forces' capabilities. The Defence Act mandates that the country must prepare its Defence White Book and keep it updated.



# Venezuela

## The Legal Framework and the Defence System

### National Legislation

#### Systems and Concepts

- National Security Organic Act (GO N° 37.594 - 2002/12/18)

#### Military Organization

- Organic Code of Military Justice (GO N° 5.263 - 1998/09/17)
- Organic Act of the Bolivarian National Armed Force (GO N° 5.891 - 2008/07/31. Last amendment: GO N° 5.933 - 2009/10/21)
- Act of Military Service and Enrolment (GO N° 5.933 - 2009/10/06)

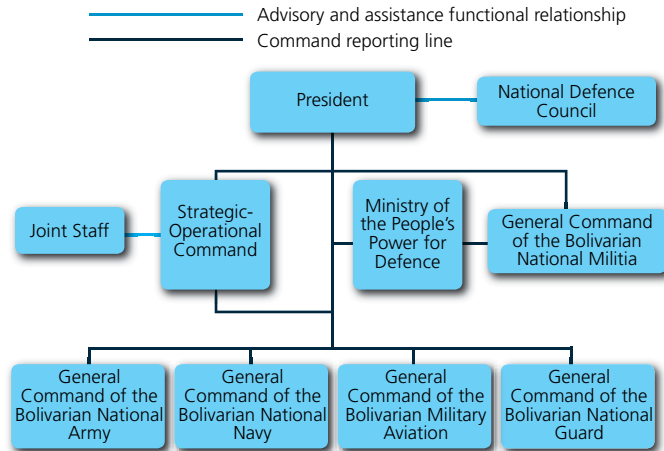

The President is advised by the National Defence Council, composed of the Vice President, the Presidents of the Assembly, the Supreme Court of Justice and the Republican Moral Council, and the Ministers of Defence, Internal Security, Foreign Affairs, Planning and the Environment. The Strategic Operational Command is directly subordinate to the President and is the highest planning and management organ of the Armed Forces and the Bolivarian Militia. The Joint Staff is its planning and advisory body. The Strategic Operational, the Military Components (Army, Navy, Military Aviation and National Guard), the Bolivarian Militia and the Military Regions (as operational organization), are administratively under the Ministry of Popular Power for Defence. The Assembly holds the powers granted by the Constitution and permanently monitors defence related issues through the National Defence and Security Committee.

**Source:** Compilation based on the Political Constitution, *Ley orgánica de seguridad de la Nación* (GO N° 37.594 - 2002/12/18) and *Ley orgánica de la Fuerza Armada Nacional Bolivariana* (GO N° 5.891 - 2008/07/31. Last amendment: GO N° 5.933 - 2009/10/21).

**Source:** Compilation based on the legislation above mentioned. For constitutional provisions see Chapter 1

## The Budget

Year	Defence Budget (in US\$)	Government Budget (in US\$)	GDP (in US\$)
2006	1,867,024,633	36,217,120,783	134,628,000,000
2007	2,612,441,958	53,571,207,838	226,922,000,000
2008	3,351,756,259	63,984,953,854	334,726,000,000
2009	4,185,502,812	77,894,964,467	353,469,000,000
2010	2,501,244,477	46,204,655,586	301,012,000,000

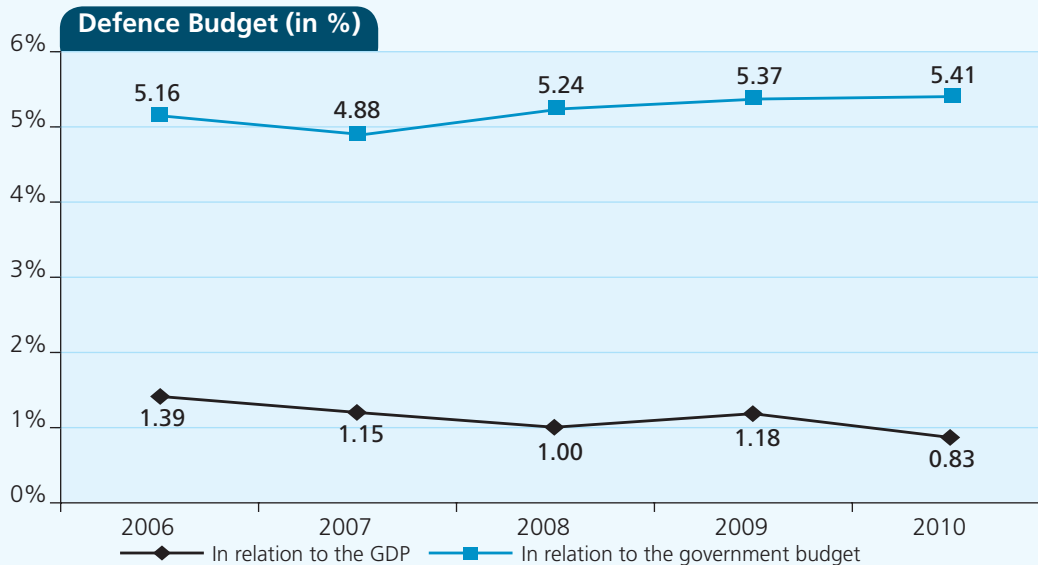

## Defence Budget Breakdown

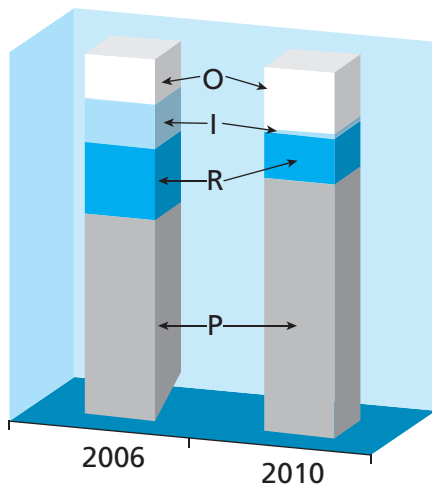

P: Salaries and other benefits  
R: Retirement and pension funds / I: Investment  
O: Other expenses

## Comparative Increase (% variation 2006-2010)

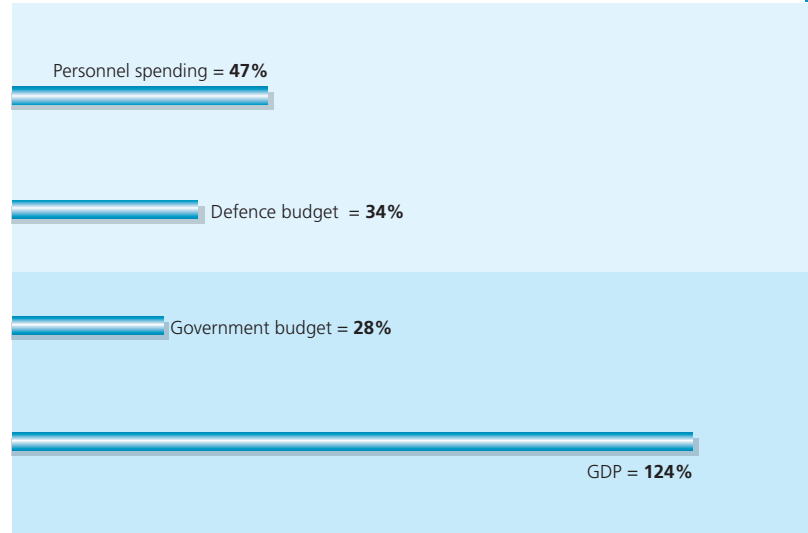

## Defence Budget 2010 (in Local Currency)\*

Credits	Consumer Goods and Services Expenses**	Real Assets	Others***	Personnel Expenses	TOTAL
<b>Ministry of the People's Power for Defence</b>					
Military Attorney General	899,160	0	0	0	899,160
Operational Strategic Command	309,193,814	0	0	0	309,193,814
Office of the Vice-minister of Services	139,488,361	0	0	0	139,488,361
Information (Military Intelligence Directorate, D.I.M.)	3,641,017	0	35,504,249	0	39,145,266
Presidential Honour Guard	17,383,981	0	0	0	17,383,981
Military Public Defender's Office	2,762,239	0	0	0	2,762,239
Acquisitions Directorate of the Army	15,296,175	0	0	0	15,296,175
Naval Logistics Command	0	90,690,183	0	0	90,690,183
Senior Directorate of the Military Criminal Legal Circuit	1,497,528	0	0	0	1,497,528
Acquisitions Directorate of the Aviation Logistics Command		14,024,611	0	0	14,024,611
General Comptroller	1,664,145	0	0	0	1,664,145
Office of the Vice-minister of Education for Defence	60,392,209	0	0	0	60,392,209
Directorate of Militia Services	17,367,049	0	0	0	17,367,049
Statistics	257,538	0	0	0	257,538
Military Health Directorate	241,588,762	0	0	0	241,588,762
Administration Office	0	0	1,107,944,032	0	1,107,944,032
Centralised Actions					
Management and Coordination of Workers' Expenditures	25,791,292	0	0	6,074,208,708	6,100,000,000
Administrative Management	167,009,086	31,990,657	97,240,720	0	296,240,463
Social Security and Protection	0	0	130,000,000	0	130,000,000
Military Attaché's Offices	0	0	18,457,931	0	18,457,931
<b>Ministry of the People's Power of the President's Office</b>					
National Defence Council	3,847,160	170,000	594,415	20,388,425	25,000,000
<b>TOTAL</b>	<b>1,008,079,516</b>	<b>136,875,451</b>	<b>1,389,741,347</b>	<b>6,094,597,133</b>	<b>8,629,293,447</b>

\* As of 31 August 2010, the Ministry of Defence was allocated additional Credits for 1,837,648,426 Bolívares (US\$ 532,651,718). Such amount has not been included above.

\*\* It includes Materials, Supplies and Goods as well as Non-Personnel Services.

\*\*\* It includes Defence and Security Expenses of the State, Transfers and Donations. Decrease of Liabilities and other expenses. Transfers to the Institute of Social Services for the National Armed Forces (IPSA) account for 1,057,242,440 Bolívares.

## Composition of Defence Budget 2010

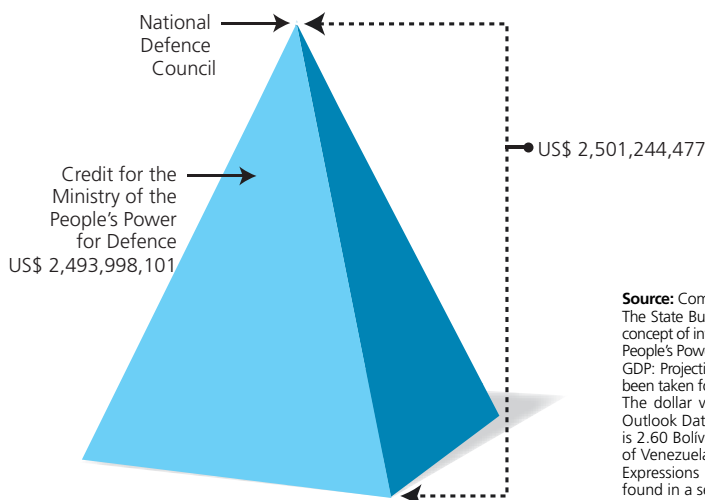

In 2007, the government signed the following military acquisitions agreements with:

- Belarus: US\$ 1,051,475,811
- China: US\$ 199,018,000
- Iran: US\$ 71,159,751
- Russia: US\$ 3,794,380,777

Such numbers account for 40% of the defence budget in the last 4 years.

Financing terms vary from case to case. As of 2010, the payment schedule and delivery of acquired units are still under way.

**Source:** Compilation based on *Ley de presupuesto para el ejercicio fiscal* 2006, 2007, 2008, 2009 and 2010. The State Budget passed by the Congress by means of the above mentioned Act is considered herein. The concept of investment is that expressed in "Real assets". Acquisitions: *Memoria y Cuenta* 2007, Ministry of the People's Power for Defence. Additional credits: *Gaceta Oficial de Venezuela*.  
GDP: Projection of the World Economic Outlook Database, IMF, of each year under review. This source has been taken for comparative purposes. Each country prepares the budget based on its own GDP estimation. The dollar value considered corresponds to the exchange rate determined by the World Economic Outlook Database, IMF, for each year under consideration. As of July, the 2010 exchange rate average is 2.60 Bolívares (type 1) and 4.30 Bolívares (type 2), based on the data provided by the Central Bank of Venezuela. For further calculations, figures are provided in local currency.  
Expressions in Bold Type (Table) make reference to the various defence budget items, which can be found in a sector-based or institutional classification of the Budget Act.





**The Ministry of the People's Power for Defence**

**Responsibility:**

It is the highest administrative body as regards the military defence of the Nation, responsible for the formulation, adoption, monitoring and assessment of the policies, strategies, plans, programs and projects of the defence sector. The President and Commander-in-Chief is entitled to issue operational orders through the Ministry of the People's Power for Defence.

(Ley orgánica de la Fuerza Armada Nacional Bolivariana, GO N° 5.891 - 2008/07/31. Last amendment: GO N° 5.933 - 2009/10/21, Sec. 11 and 20)

**Organization Chart**

**Higher Level**

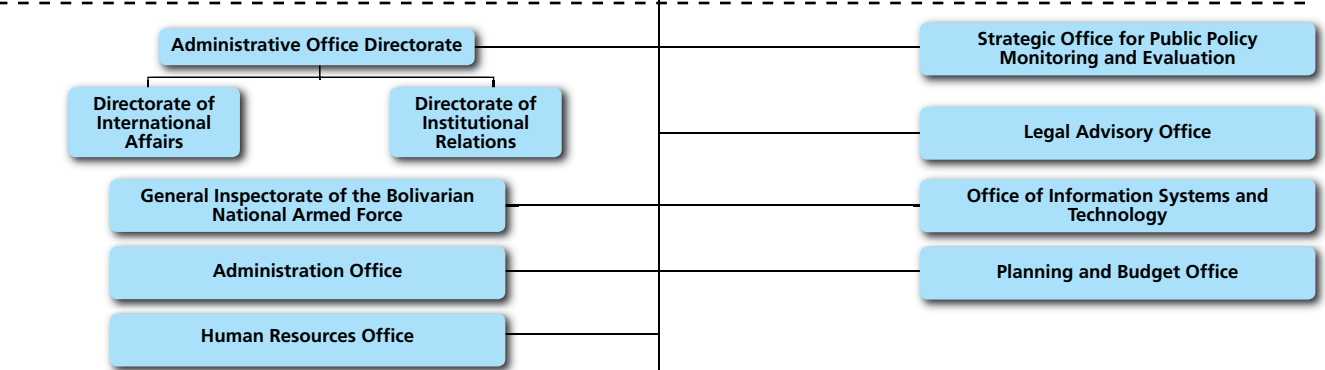
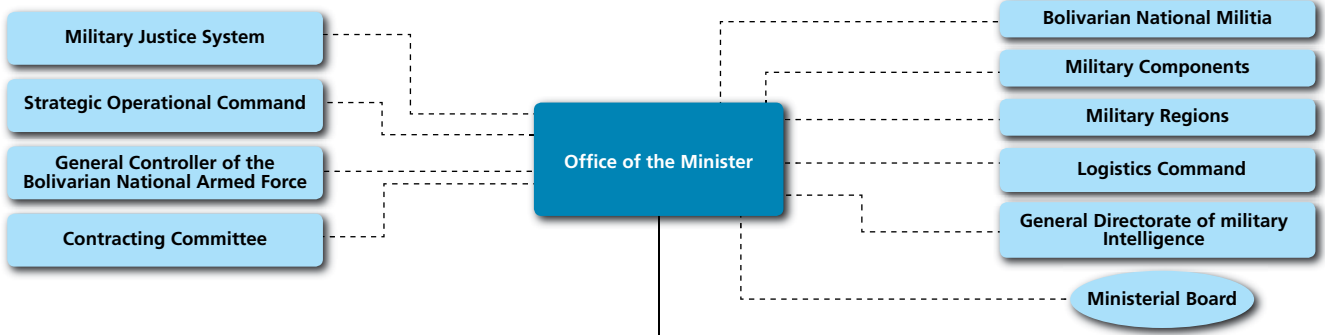

**Support Level**

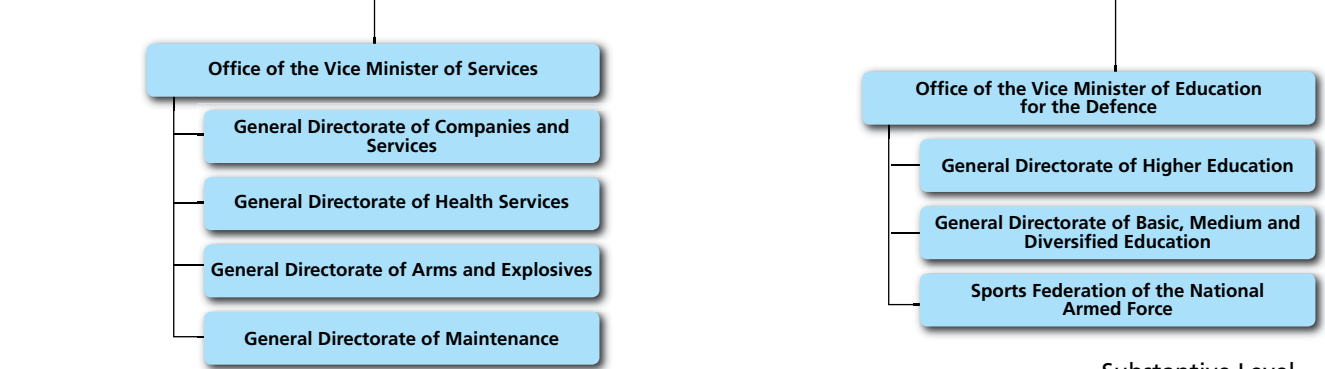

**Substantive Level**

<b>Date of Foundation:</b> 1946
<b>Current Minister (September 2010) :</b> Carlos José Mata Figueroa
<b>Can military members be Ministers of Defence?:</b> Yes
<b>Number of military members who were Ministers of Defence:</b> 39
<b>Number of civilians who were Ministers of Defence:</b> 1
<b>Have there been any women in charge of the Ministry of Defence?:</b> No
<b>Average permanence in the Minister of Defence position:</b> 1 year and 7 months

[The Minister currently in charge is not considered. The creation date is related to the moment in which the term "Defence" becomes part of the Institution's name]

Source: Ministry of the People's Power for Defence.

**Political Definitions**

**Policy Guidelines**

**New International Geopolitics:**

Building a multipolar world implies creating new poles of power that may represent a break from the unipolar hegemony, in the search for social justice, solidarity and peace assurance, deepening a fraternal dialogue between the peoples, self-determination and respect for the freedom of ideas.

The development of a new world geopolitical era is based, among other things, on the following assumptions:

- Identify and define a new development policy and articulation of the new geopolitical poles of power in the world.
- Strengthening common political interests between countries.
- Deepening friendship, trust and solidarity for a peaceful cooperation and co-existence among peoples.
- Determine energy development as a key foundation for the creation of a new geopolitical map.

To make Venezuela a global refining centre and a petrochemical power is yet another guarantee –and a very important one– for the defence of national sovereignty. National sovereignty is never a given conquest; it must always be defended and there may a risk of losing it. The sovereignty of a country rich in hydrocarbons is always at stake. However, it is also a potentially powerful defence weapon. The best defence is, without doubt, to tap such resource and fully develop it in all its phases, within and outside the national territory.

**Institutional Objectives of the Defence Sector**

- Organize, maintain, equip and train National Armed Force units for the development, deployment and employment of the military component, so as to secure national defence.
- Build the necessary human resources to meet the requirements of the National Armed Force (FAN), and train them to comply with the assigned mission.
- Provide the necessary socio-economic conditions and welfare for the members of the National Armed Force, for the purposes of improving the life quality of FAN's members and their families.
- Be prepared to support and guarantee the stability of democratic institutions, within the standing legal framework of the National Armed Force.
- Execute and support actions destined to contribute to national development.
- Design and strengthen management activities for the purpose of ensuring an optimum operation of FAN's units and dependencies.
- Effectively manage human resources, material and financial resources from foundations, public institutes, partnerships and corporations, decentralized services and civil associations linked to the defence sector, so as to ensure compliance with the social purpose and objective for which they were created, and support the efficient management of the National Armed Force.

**Projects**

1. Ensure military operations execution to contribute to defence and to the Nation's integral development.
2. Support logistic activities to enable National Armed Force operational capacity.
3. Intelligence operations to preserve National security.
4. Develop actions inherent to the organization of Venezuela's civil society, contributing to the integral defence of the Nation.
5. Integral healthcare provided through the military healthcare system.
6. Educate, develop and train human talents of the National Armed Force and the people in general.
7. Presidential security, custody and protection services.
8. Services and infrastructure to ensure the operational level of the National Armed Force.
9. Military Legal Criminal System.
10. General Military Prosecutor.
11. Military Public Defenders.
12. Exercise control, surveillance and oversight of public revenues, spending and assets assigned to the sector.
13. Statistical information system.

Source: *Proyecto Nacional Simón Bolívar. PPS – Plan de Desarrollo Económico y Social de la Nación 2007-2013 and Ley de presupuesto para el ejercicio fiscal 2010.*

**Reports Submitted to the United Nations and the OAS**

1997	1998	1999	2000	2001	2002	2003	2004	2005	2006	2007	2008	2009
✘					✘							
		✱										

Register of Conventional Arms: ✘ Register of Military Spending: ✧ Application of measures for confidence and building and security: ✱

Source: Compilation based on reports submitted to the United Nations Register of Conventional Arms and the United Nations Instrument for Reporting Military Expenditures and reports submitted to the OAS on the Implementation of Confidence and Security-Building Measures.



## The Armed Forces

### General Mission

The National Armed Force, organized by the State and regulated by the principles of territorial integrity, cooperation, solidarity, concurrence and co-responsibility, has the mission to guarantee the independence and sovereignty of the Nation, ensure territorial integration, security of the Nation, active participation in national development, cooperation in maintaining internal order, and the defence of the democratic exercise of the people's will embodied in the Constitution of the Bolivarian Republic of Venezuela and the laws of the Republic.

The Bolivarian National Armed Forces of Venezuela shall:

- Ensure the domain of vital spaces which may allow the circulation of people and assets across the different regions of the country and the international environment.
  - Defend the strategic sites that guarantee the development of activities in various areas such as economic, social, political, cultural, geographic, environmental and military areas, and take precautions necessary to prevent any invasive power from controlling them.
  - Prepare and organize the people for an integral defence, with the purpose of cooperating and collaborating with the independence, sovereignty and territorial integration of the Nation.
  - Participate in alliances or coalitions with the Armed Forces of Latin American and Caribbean countries for integration purposes within the conditions established in treaties, agreements and accords, previously approved by the National Assembly.
  - Take part in peace missions within the framework of UN Charter provisions, as previously instructed by the Head of State and approved by the National Assembly.
  - Support the government institutions at a national, regional or local level, for the execution of tasks associated with the economic and social development of the people, as well as in civil protection operations in disaster situations.
  - Contribute with law-enforcement agencies at the national, state and municipal levels, to preserve or restore internal order in cases of serious social disturbance, as previously approved by the Head of State.
  - Organize, operate and direct the National Armed Force intelligence system as well as counterintelligence system.
- (Ley orgánica de la Fuerza Armada Nacional Bolivariana, GO N° 5.891 - 2008/07/31. Last amendment: GO N° 5.933 - 2009/10/21).

### Specific Missions

#### Army

Ensure the defence of the land; contribute to the stability of democratic institutions and respect for the laws of the Republic; support national development and integration; and prepare to take part in international peacekeeping programs.

#### Navy

Ensure naval defence and compliance with the Constitution and laws in effect; cooperate in maintaining internal order and actively participate in national development, in order to guarantee the independence, sovereignty and integrity of national water spaces.

#### Air Force

Ensure national defence by controlling the national air space, contributing to the sustainment of public order and actively participating in the development of the country, employing the national air power to guarantee the territorial integrity, independence and sovereignty of the Nation.

#### National Guard

Conduct the operations necessary for maintaining the country's internal order, cooperate in the development of military operations to ensure the defence of the Nation, exert administrative law enforcement and criminal investigation activities assigned by law, and actively participate in national development within the territory and other geographic spaces of the Bolivarian Republic of Venezuela.

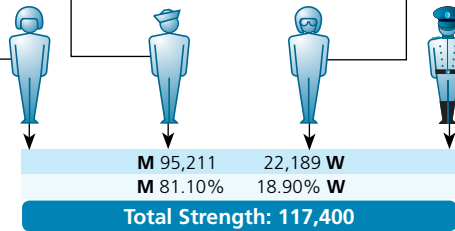

M: Men / W: Women

Source: Websites of the Armed Forces (missions) and Ley de presupuesto para el ejercicio fiscal 2010 (Regular Force).

## Women in the Armed Forces

### Women's Admission to the Armed Forces (year)

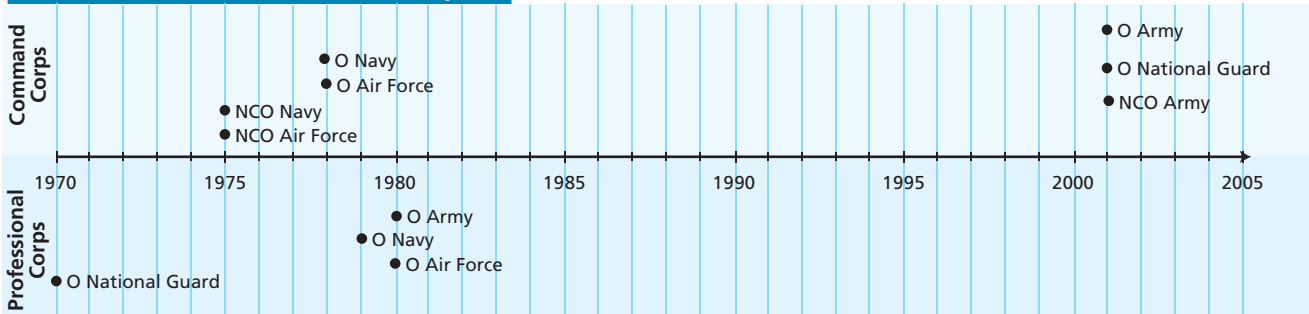

Notes: Under the National Bolivarian Armed Force organization bylaw (GO N° 6,239 – 13/08/2009), professional enlisted NCO's are transferred to the technical officer career. The Command corps includes officers who have been educated at military academies from the beginning of their professional careers. The Professional corps refers to those who develop a career in the civilian sphere and are then incorporated to the armed forces.

### Women Officer who have reached the highest rank in the Command Corps (2010)

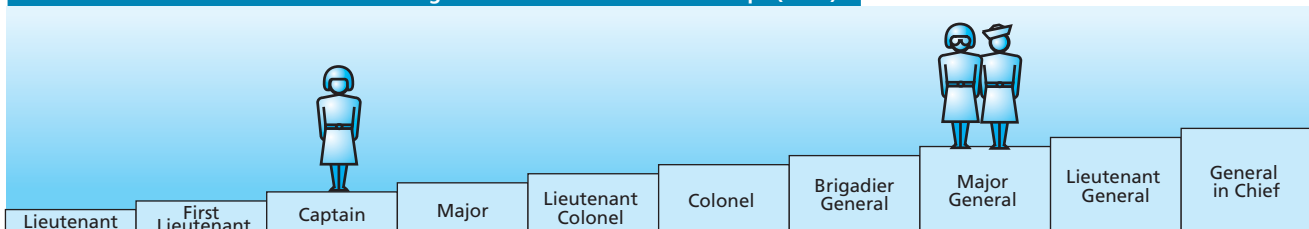

Note: These ranks correspond to the Army, as an example. The equivalent ranks for Major General are Vice-Admiral (Navy) and Major General (Air Force).

Source: Compilation based on information provided by the Ministry of Defence and the Armed Forces.

## Bolivarian National Militia

The Bolivarian National Militia (Milicia Nacional Bolivariana) is a special corps organized by the Venezuelan State which includes the Military Reserve and the Territorial Militia responsible for supporting the Bolivarian National Armed Force in the integral defence of the Nation, in order to contribute to ensuring its independence and sovereignty.

It reports directly to the President of the Bolivarian Republic of Venezuela and Commander in Chief of the Bolivarian National Armed Force in all matters relating to operational aspects; as for administrative affairs, it shall report to the Minister of People's Power for Defence.

Its mission is to train, prepare and organize the people for the integral defence of the country, in order to supplement the operational readiness of the Bolivarian National Armed Force, contribute to maintaining internal order, security, defence and overall development of the Nation, with the purpose of contributing to the independence, sovereignty and integrity of the Nation's geographic spaces.

It is organized under a General Commander, a Deputy Commander, a Chief of Staff, an Inspector General, General Directors, General Director of Conscription and Readiness of Integral Defence, Groups, Military Reserve Battalions, Territorial Militia Units, Combat Bodies and operational and administrative offices as required.

### It main missions are to:

**Bolivarian National  
Militia Strength (2010)**  
48,010

- Prepare, organize, equip, instruct, train and retrain the Bolivarian National Militia established.
- Create ongoing links between the National Armed Force and the Venezuelan people, so as to contribute to ensuring the overall defence of the Nation.
- Organize and train the Territorial Militia, to carry out the overall defence operations aimed at guaranteeing national sovereignty and independence.
- Provide the replacements necessary to supplement and reinforce active units of the Bolivarian Armed Force in its military operations.
- Coordinate the activities required for the conscription, according to the laws and regulations in effect.
- Keep the National Registry of Conscripts and prepare the regular annual contingents for the Bolivarian National Armed Force.
- Receive from Military Components, an updated record of professional military personnel who have completed the active duty service, as well as the record of licenced troops.
- Support the Operational Strategic Command in the elaboration and execution of the national integral defence plans and national mobilization.
- Participate and contribute to the development of military technology and industry.
- Guide, coordinate and provide support in its areas of competence to the Community Councils (Consejos Comunales) in order to contribute to the attainment of public policies.
- Contribute to, and advice on, the creation and consolidation of Integral Defence Committees of Community Councils, in order to strengthen civil-military relations.
- Collect, process and disseminate information from the Community Councils, public and private sector institutions, necessary for the elaboration of integral development plans, programs and projects for the Nation as well as national mobilization efforts.
- Coordinate with public and private sector bodies, entities and offices, the establishment and organization of the Reserve Combat Corps (Cuerpos Combatientes de Reserva).
- Oversee and train such combat corps, which shall operationally fall under the National General Command of the Bolivarian National Militia.
- Elaborate and keep an updated record of reserve personnel with residence in strategic defence regions including members of the Territorial Militia.

### The Military Reserve:

The Military Reserve includes all Venezuelan men and women of adult age who have fulfilled the military service duty or may voluntarily join the Reserve Units or Combat Corps.

The Territorial Militia is composed of citizens, both men and women, who voluntarily organize themselves to fulfill the Integral Defence functions of the Nation, in accordance with the principle of co-responsibility between the State and civil society.

Both shall be registered by the General Command Headquarters (*Comandancia General*) of the Bolivarian National Militia, and shall thus act under its command and conduct.

## Military Service

The Venezuelan people, according to the Constitution of the Republic, have the duty to register at the Military Registry, but the service is optional for one year.

### It offers two modalities:

- Full-time: regular service performed in a continuous and uninterrupted way at operational and administrative military units established by the Bolivarian National Armed Force.
- Part-time: they stay in the barracks for a specific time, enabling them to study or have a job, thus ensuring their professional growth and economic and social stability for themselves and their families.

The military service can be provided at the Bolivarian Armed Force Components, the Bolivarian National Militia or at other units under the scope of the Ministry of the People's Power for Defence.

**Source:** *Ley de conscripción y alistamiento militar* (GO N° 5.933 – 2009/10/06), *Ley orgánica de la Fuerza Armada Nacional Bolivariana* (GO N° 5.891 - 2008/07/31). Last amendment: GO N° 5.933 - 2009/10/21), *Ley de presupuesto para el ejercicio fiscal 2010* and website of the Bolivarian National Militia.



Military Career

Commissioned Officers' Career Path<sup>1</sup>

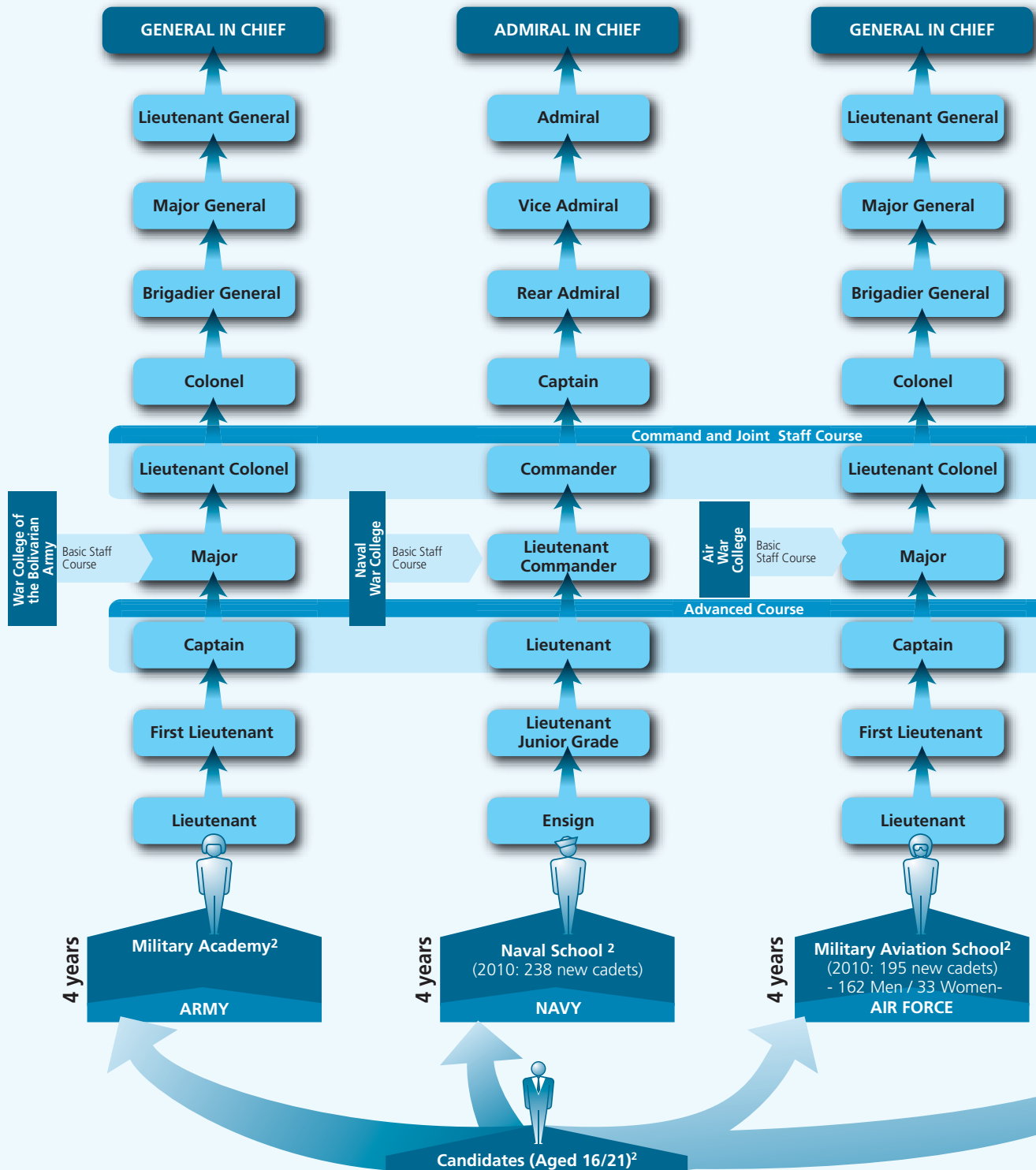

1 Command corps includes officers who have been educated at military academies from the beginning of their professional careers. The graph makes a theoretical reconstruction of officers' promotion through the completion of mandatory courses. Further requirements for promotion have not been considered.

2 The Bolivarian Military University has been created by Decree N° 7.662 - 2010/09/03. Said institution will be in charge of the National Bolivarian Armed Force education.

3 The age of 16-21 has been considered for comparative purposes. Entry age varies depending on the services: Army: 16-21, Navy: 18-23, Air Force: 16-21. The minimum age for promotion will depend on the age of graduation from the appropriate military education institution.

Source: Compilation based on the *Ley Orgánica de la Fuerza Armada Nacional Bolivariana* (GO N° 5.891 – 2008/07/31. Last reform: GO 5.933 – 2009/10/21). New cadets: Information provided by the Ministry of Defence website and the military academies.

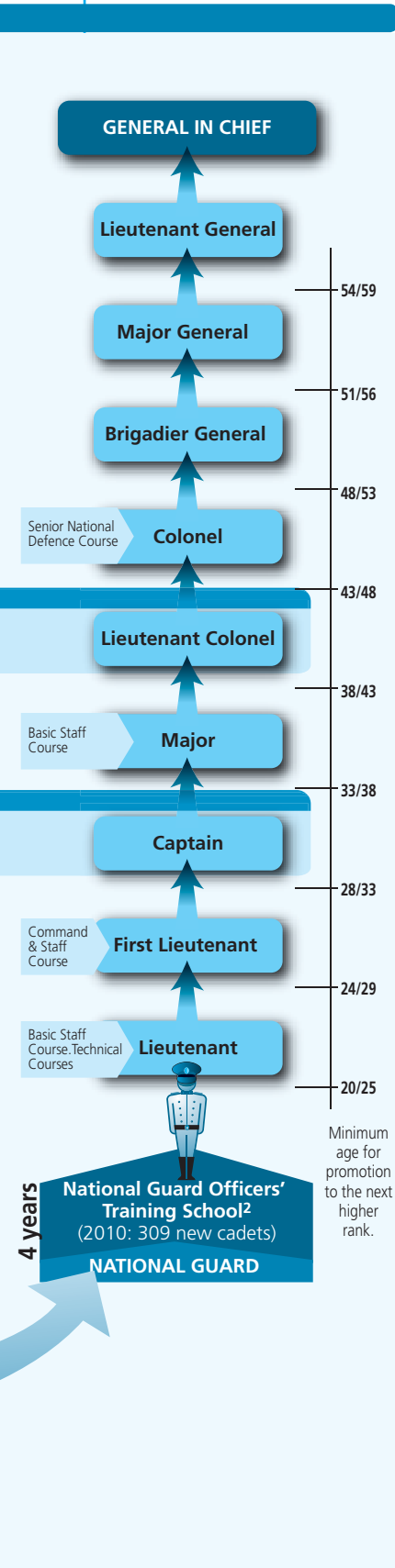

**Defence and National and International Community**

**Support Actions**

The Bolivarian National Armed Force, in conjunction with national, state and city agencies, actively engages in the integral development of the Nation

**Examples of actions undertaken in 2010**

<p><b>Churuguara</b></p> <ul style="list-style-type: none"> <li>• Medical and dental checkups: 844.</li> <li>• Surgeries: 13.</li> <li>• Medicine distribution: 592.</li> <li>• Food at low prices: 21 tons, benefiting 3,200 people.</li> </ul>	<p><b>Santa Cruz de Bucaral</b></p> <ul style="list-style-type: none"> <li>• Medical and dental checkups: 520.</li> <li>• Medicine distribution</li> <li>• Food at low prices: 21 tons, benefiting 2,686 people..</li> </ul>
<p><b>Tocópero</b></p> <ul style="list-style-type: none"> <li>• Medical and dental checkups.</li> <li>• Medicine distribution.</li> <li>• Food at low prices.</li> </ul>	<p><b>Borojó</b></p> <ul style="list-style-type: none"> <li>• Medical services.</li> <li>• Food at low prices</li> </ul>
<p><b>Boca de Aroa</b></p> <ul style="list-style-type: none"> <li>• Medical and dental checkups: 100.</li> <li>• Medicine distribution: 145.</li> <li>• Food at low prices: 14 tons, 1,600 beneficiaries</li> </ul>	<p><b>Las Cumaraguas</b></p> <ul style="list-style-type: none"> <li>• Medical and dental checkups.</li> <li>• Medicine distribution.</li> <li>• Cleaning of facilities at Basic School and ambulatory one.</li> <li>• Cleaning of Médano Caribe beach: 1,6 tons of solid waste collected.</li> <li>• In total, 1,200 people benefited.</li> </ul>
<p><b>Puerto Cabello</b></p> <ul style="list-style-type: none"> <li>• Medical and dental checkups.</li> <li>• Medicine distribution.</li> </ul>	<p><b>Alto Orinoco</b></p> <ul style="list-style-type: none"> <li>• Support to 1,800 indigenous people from the Yanomami group.</li> <li>• Medical and dental checkups.</li> <li>• Medicine distribution.</li> <li>• Vaccination.</li> </ul>

**Defence of Natural Resources**

The Armed Forces have the mission to protect strategic-interest industries including, most especially, the oil industry. Petroleos de Venezuela S.A. is the state-owned corporation of the Bolivarian Republic of Venezuela in charge of exploration, production, manufacturing, transport and sale of hydrocarbons.

**Integral Defence System of the Orinoco Oil Basin**

In March 2010, the Corporación Venezolana de Petroleo, an affiliate of Petroleos de Venezuela S.A., which controls and manages all business operations carried out with other national or foreign capital oil companies, announced that it is planning to implement an Integral Defence System for the Orinoco Oil Basin, with a view to provide for the security and sovereignty of the liquid hydrocarbon reserve source. A cross-functional team from the Operational Strategic Command of the Bolivarian National Armed Force and Petroleos de Venezuela S.A. was entrusted with the mission to design the pilot project.



**Orinoco Oil Basin**

One of the largest sources of liquid hydrocarbon reserves in the world, covering 55,314 km<sup>2</sup> and a current production area of 11,593 km<sup>2</sup>.

Oil Proven Reserves in Venezuela (billion barrels)		
1989	1999	2009
59	76	172

At present, Venezuela is the second world country in oil proven reserves, with 12.9% of total reserves in the world.

**Counter-narcotics Actions**

**Anti-Narcotics Offices**

Each of the Armed Forces components has an Anti-Narcotics Office, set up at the headquarters of their respective General Commands, which operate under the scope of the Inspection Division of each Force. Their mission is to provide support to the different units and internal offices regarding prevention, evaluation, treatment and investigation in relation to the illegal consumption, possession and trafficking of narcotics and psychotropic substances.

Service	Drugs seized and detained persons in 2009						Detenidos
	Drug seizures (in kg)						
	Cocaine	Marihuana	Heroine	Bazuco	Crack	Total	
National Guard	19,864.36	13,640.41	79.11	8.45	10.23	33,602.56	723
Navy	2,262.00	-	-	-	-	2,262.00	8
Army	40.00	-	-	-	-	40.00	5

**Source:** Ministry of the People's Power for Defence, the Ministry of People's Power for Energy and Oil, the Armed Forces and the National Anti-Drug Office. *British Petroleum Statistical Review of World Energy*, 2010.



Analisis:

## Venezuela's Defence Sector: National and International Landmarks (2008-2010)

**Francine Jácome**

*Executive Director of the Venezuelan Institute of Social and Political Studies (INVESP) and coordinator of the Venezuela Working Group of the Friedrich Ebert Regional Security Program.*

Changes have been witnessed since 2008 in terms of initiatives undertaken by the Venezuelan government for the defence sector, both domestically as well as in the international arena, through various proposals and international participation. In the former case, the main highlights include legal reforms and military equipment procurement and, internationally, several proposals within the framework of the recently-created South American Defence Council (CDS) and concurrent inputs at the Bolivarian Alliance for the Peoples at Our Americas, *Alianza Bolivariana para Nuestros Pueblos de las Américas* or ALBA).

Over the last few years, a so-called *de facto* reform has been introduced through a series of laws adopted by the Presidency of the Republic, enabled by an Authorizing Act that empowers the Executive to legislate at certain periods, as well as by the National Assembly. This includes the adoption in July 2008 of the new Organic Law of the Bolivarian National Armed Force.

One of the most relevant changes has been the use of the term "Bolivarian", which has raised a debate around the substitution of the professionalization aspect for ideology, claiming that the military's acceptance and endorsement to the socialism project of the 21<sup>st</sup> century demonstrates the predominance of one concept over the other.

Another fundamental element has been the introduction of the Bolivarian National Militia, defined as a special body created to complement the Bolivarian National Armed Force (FANB), which includes the National Reserve, and the newly-created Territorial Militia. Some of the responsibilities of the militias include that of establishing the link between the FANB and the people

for the nation's defence; organize and train the Territorial Militia; coordinate, support and guide the work of the Community Councils<sup>1</sup>, and contribute to the creation of the Community Councils' Defence Committees to strengthen civil-to-military relations. Furthermore, militias will play a role in compiling information from Community Councils, a duty that has been interpreted as an indirect way of assigning them intelligence tasks.

Other functions include preparing and organizing citizens for an integral defence, participating in alliances or coalitions with other countries' military for the purposes of integration –previously approved by the Assembly, cooperating for the preservation or reinstatement of public internal order, as well as designing a strategic development plan for the FANB in line with the national economic and social development plan. These transformations, coupled with others developed since 1999, have led to a considerable shift in civil-military relations, by assigning the military a new role while weakening civilian control. The design of defence and security policies is basically in the hands of an elite of active-duty and retired military and, in practice, considering all these mentioned roles, the military have an active participation in relevant aspects in the life of the country, including public administration, infrastructure, health, and key state-owned companies.

As for conflict scenarios, the need for the country to prepare for a scenario of asymmetrical warfare, likely to be headed by the United States, which could result in a military intervention, has been strongly maintained. In this sense, the proposed counteraction has been a so-

<sup>1</sup> Grassroots community organizations promoted by the central government.

called “war of all the people”. However, high-ranking government officials have recognized that the possibility of a direct intervention by the US is low and, therefore, they have widened the notion that such intervention could follow two modalities that could eventually be simultaneously implemented. The first mode would emanate from different domestic sectors, thus reinforcing the concept of the “internal enemy.” The second modality is associated with the assertion that the northern-hemisphere country could advance in a “surgical” action, as it did in Panama –the Noriega case- or help in the planning of a “magnicide”.

Faced with these scenarios, the Venezuelan government has developed, in the last couple of years, a military procurement strategy that, combined with that of other countries, has raised intense debate on whether a new “arms race” has been launched in the region, or whether it is merely a matter of reequipping the military. In this case, there are contradictions between conflict scenarios and the type of equipment acquired. The ruling government has insisted in that these purchases have a defensive purpose, basically to be used for a conventional offensive from an enemy with similar power, thus contradicting the hypothesis of a “war of resistance”.<sup>2</sup>

### South American Council and ALBA

The South American Defence Council (CDS) was set up within UNASUR’s framework and has focused on establishing a mechanism for dialogue and conflict prevention, particularly during the first half of 2010. Participating governments have assumed commitments and, therefore, as in the case of the other member countries, the fundamental question is whether the Venezuelan government will deliver on such commitments; especially given the strained and conflictive relations with its neighbour, Colombia.

In January 2008, the Venezuelan government stated the need for creating a joint military force, as well as an ALBA’s defence council, which would allow a joint action in the event of a hypothetical aggression from the United States to one of the members of the Alliance.<sup>3</sup> This, in turn, was reinforced by the government’s direction towards establishing an anti-American axis and its rapprochement with countries such as Iran, China, Russia, Syria, Libya and Belarus, among others.

These actions come as a response to the different perspectives on integration in general, and, more spe-

cifically, to security and defence. Ten years after taking the first steps towards integration of the twelve South American countries, UNASUR has prioritized political dialogue and focused on the defence matter. By contrast, four years after its creation, ALBA is raising the need for defence against imperialism. Its focus lies on the relationship between the region and the United States and on a joint response in the face of an aggression by the latter. During the VII Summit in Cochabamba (October 2009), a Permanent Committee for the Sovereignty and Defence of ALBA was created, for the purposes of defining a popular joint and integrated defence strategy and establishing the School of Dignity and Sovereignty of the Armed Forces of ALBA member countries, which could be considered a parallel institution to the recently-created UNASUR’s South American Center of Strategic Defence Studies, headquartered in Buenos Aires.

In conclusion, some of the short-term trends (2010-2011) could include:

#### *At the domestic level:*

- Strengthening of a narrow and authoritative idea of security based on statist and military response vis-à-vis a democratic perspective aimed at introducing non-state actors and civilian predominance in decision-making processes.
- Greater involvement of the military in the current political and economic elite of the country.
- Internal tension within the FANB between the sector accepting the political-partisan perspective and those upholding a professional and institutional vision of the Armed Force.
- Debates on civil-military relations, particularly in view of the increasing militarization of society.

#### *At the international level:*

- Intensification of the regional disintegration process, particularly as regards defence and security. For instance, it seems unlikely that confidence-building measures agreed upon in the last CDS meeting could be implemented in the short-term.
- Attempts to create a parallel institution through ALBA, although this will be impacted by the seemingly growing weakness of the Venezuelan government proposals in the international arena.
- Tension will remain between the Venezuelan Government and the Colombian and US governments, but within the framework of the pragmatism that differentiates rhetoric from trade relations.

<sup>2</sup> González, David (2009): *Las armas de la discordia*, *El Nacional*, Caracas, October 4, pg. 1-2-Siete Días.

<sup>3</sup> Madero, Elinor (2008): *Chávez plantea creación de fuerza militar conjunta del ALBA*, *El Nacional*, January 28th, pg. 2.







# HAITI

In February 2004, after years of relentless crises, Haiti was on the verge of civil war, posing challenges and threats in multiple dimensions of the region's security. Faced with this situation, the United Nations decided to establish a peace mission (MINUSTAH), which from the beginning received strong commitment from Latin American countries. Such commitment was embodied by an unprecedented political joint effort in the defence sphere. The formation of multilateral groups, the permanent contact between Ministries, the creation of joint battalions and a declared concern for the situation, are some of their expressions. After the earthquake occurred on January 12, 2010, every region in the world supported and supplemented the actions of a MINUSTAH tragically damaged and overwhelmed by the magnitude of the disaster. In the Latin American case, the need to consolidate political channels allowing to react in an efficient manner when confronted with urgent situations became evident. This issue provides updated data on Haiti and MINUSTAH, the international reaction and assistance in times of disaster and current mission challenges within this new context.

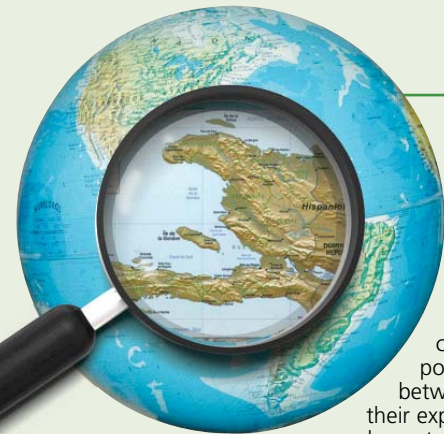

**Population:**  
10,089,000 (2009)

**Fatalities of the earthquake that struck Haiti on January 12, 2010:**  
222,527.

**Security:**  
Haitian National Police (PNH): 4,391.

**MINUSTAH troops (as of August 23, 2010):** 11,611.

**President:**  
René Prévail

**Prime Minister:**  
Jean-Max Bellerive

**Next elections:** 2010/11/28

**Alliances and competing parties:** 66

**Presidential candidates:** 19

**International Observers or Representatives monitoring the conduct of elections:** CARICOM, MINUSTAH, OAS.

Year	Date	Event
2004	04/30	MINUSTAH was established.
	07/19	International Donors' Conference Towards a New Future for Haiti – Washington
2005	05/13	1st 2x4 Meeting*
	08/19	1st 2x7 Meeting*
2006	07/25	International Donors' Conference Towards a New Future for Haiti – Port-au-Prince
	11/29	International Donors' Conference Towards a New Future for Haiti – Madrid
2008	09/04	2nd 2x7 Meeting*
	26/10	1st 2x9 Meeting*
2009	04/14	International Donors' Conference Towards a New Future for Haiti – Washington
	11/4-05	1st Hemispheric Conference on Coordination of the International Cooperation with Haiti
2010	01/12	<b>Earthquake</b>
	01/13	The Dominican President Leonel Fernández visits Haiti and orders the Dominican Armed Forces to provide immediate assistance (Decree No. 24/10). Arrival of the first SOUTHCOM troops.
	01/14	Edmond Mulet is appointed Special Envoy of the Secretary-General and Head of the Mission.
	01/18	Santo Domingo Declaration: Work Together for a Better Future for Haiti.
	01/29	Security Council Resolution on the Haitian situation.
	02/09	Quito Decision: UNASUR solidarity with Haiti.
	03/31	International Donors' Conference Towards a New Future for Haiti – New York

\* Meetings of Foreign Relations and Defence Vice Ministers of Latin American countries members of MINUSTAH



Source: Websites of the Inter-American Development Bank, World Bank, Economic Commission for Latin America, South American Defence Council, UN Office of the Special Envoy for Haiti, Mexican Secretariat of Foreign Affairs and UNASUR. Map: Based on United Nations maps.



UN Photo/Marco Dormino  
Brazilian troops distributing food and water in Port-au-Prince.  
(Photo: United Nations).

## United Nations Stabilization Mission in Haiti (MINUSTAH)

Establishment Resolution 1542 of the UN Security Council, dated April 30, 2004

**Current Office:**  
Resolution 1927 of the UN Security Council (June 4, 2010).

**Approved budget**  
(July 1, 2010 to June 30, 2011):  
US\$ 380 million.

**Strength**  
(as of August 23, 2010):  
Troops: 8,548  
Police: 3,063  
TOTAL: 11,611



**Military and Police Strength (2004-2010)**

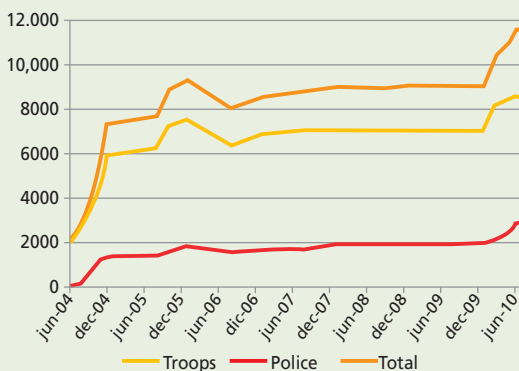

**Approved Budget MINUSTAH (in millions of dollars)**

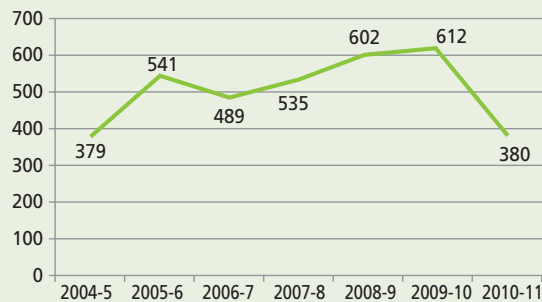

**Provisional casualties:**

- 63 service men
- 27 police officers
- 40 international officials
- 24 local civilians
- 5 others
- TOTAL: 159**



**Maximum Strength authorized by the Security Council before and after the Earthquake**

Resolution 1892 (2009/10/13)	Resolution 1908 (2010/01/19)
Troops: 6,940	Troops: 8,940
Police officers: 2,211	Police officers: 3,711

**Note:** The maximum strength authorized by Resolution 1927 (2010/06/04) is 8,940 troops and 4,391 police officers.

MINUSTAH lost 96 of its members on the earthquake that struck Haiti on January 12, 2010, including Hédi Annabi, Special Envoy of the Secretary-General and Head of the Mission; and Gerardo Le Chevallier, Head of Political Affairs.

Source: United Nations Peace Operations: Year in Review (2004 to 2007, DPKO); Secretary-General Report on the United Nations Stabilization Mission in Haiti of September 1, 2010; and UN General Assembly Resolution A/C.5/64/19, dated July 13, 2010. UN Security Council and MINUSTAH's web pages.

## New Context, New Challenges

### Security and protection

Camps for displaced persons and refugees, gender violence, child trafficking, growing number of kidnaps.

MINUSTAH provided over

**3,000**

security escorts to humanitarian organizations

### Assistance and logistics

Food shortages, growing demand of basic supplies and building materials, health crisis.

MINUSTAH's military personnel distributed 1 million kilos of food and

**13.8** million litres of water.

### Reconstruction

Damaged public infrastructure: roads, government buildings, schools.

**44,000**

sq metres were paved and

**16,400**

cubic metres of debris were removed.

### MINUSTAH's role

- Assess electoral colleges' security and devise a comprehensive electoral security and logistics programme in conjunction with the Haitian National Police.
- Increase land, maritime and air patrolling in collaboration with customs and immigration agents, the Haitian National Police and the UN civil police.
- Permanent, semi-permanent and random patrolling in displaced persons' camps.
- Provide protection to the displaced population, in coordination with human rights and gender sectors, in order to help the Haitian National Police to stop criminal activities in the camps.
- Elaborate a training programme for the Haitian National Police, the UN police and military personnel on the identification of cases of sexual and gender violence and the procedures to be followed in such cases.
- Facilitate negotiations with proprietors and promote the respect of displaced persons' rights.
- Support the Haitian Government and National Police in their child protection tasks.

- Support in relation to municipality budgets and decentralization.
- Cooperate in the establishment of legal assistance offices for displaced persons.
- Technical and logistics support to the Government and Electoral Council, in collaboration with CARICOM and OAS.
- Transport of containers carrying items donated by the Haitian population.
- Support to citizen protection offices.
- Collaborate in setting up debate forums to promote dialogue on the Government Action Plan related to national recovery and development.
- Participate in assessment missions in displaced persons' camps to include HIV prevention in the emergency response system.

- Construct temporary buildings for municipality administration offices in areas affected by the earthquake.
- Projects for drainage channels and river basin distribution system's reconstruction to face the hurricane season.
- Improve public access roads to the cities.
- Demolition of damaged government buildings.
- Remove debris from schools, churches, hospitals and children centres.
- Reconstruction of the National Penitentiary and the National Police Academy.
- Land conditioning in the main camps.

Source: Haiti: 6 Months After report and Secretary-General's reports on the United Nations Stabilization Mission in Haiti.

### 2x9 Mechanism

Meetings of Foreign Relations and Defence Vice Ministers of Latin American countries members of MINUSTAH (Argentina, Bolivia, Brazil, Chile, Ecuador, Guatemala, Paraguay, Peru and Uruguay).

It was established in May 2005 as 2x4 and then was enhanced to 2x9. Its objective is to strengthen Haiti's social and economic development as well as to improve coordination when faced with problems caused by natural disasters.

The last meeting took place in Uruguay on August 29, 2008.

### Union of South American Nations (UNASUR)

Organic Treaty of UNASUR, Article 15: it shall promote dialogue initiatives on subjects of regional or international interest and seek to consolidate cooperation mechanisms with other regional groups, States and other entities with international legal capacity.

Resolution of the South American Defence Council on the Haitian situation

Ecuador, January 29, 2010.

CDS Member countries express their solidarity with Haiti.

Quito Decision UNASUR solidarity with Haiti

Ecuador, February 9, 2010.

A US\$ 100 million fund was created and a UNASUR delegation was sent to help in the reconstruction of Haiti

Final Declaration of the Extraordinary Summit of the Heads of State and Government of the UNASUR.

Argentina, May 4, 2010. The Secretary-General was requested to establish mechanisms to guarantee UNASUR's internal coordination with the Haitian Government in the allocation of the resources of the fund for Haiti.

CDS seminar on "Lessons Learned from Peace Missions, both in the internal and multilateral environments".

Uruguay, August 31 to September 3, 2010.

Source: Web sites of the White Helmets, the South American Defence Council, Uruguay's Presidency and UNASUR.



## January 12, 2010 Earthquake

### Haiti development statistics (before the earthquake)

- 55 % of Haitians lives with less than US\$ 1.25/day.
- Annual per capita income is US\$ 660.
- 58 % of children are undernourished.
- 58 % of the population lacks access to drinking water.
- Hurricanes affected 800,000 people in 2008.
- Deforestation has left the country with less than 2% of its original forests.

### Event Statistics

- 222,570 fatalities.
- 300,572 injured.
- 2,3 million people left their homes
- 105,000 completely ruined houses and other 188,383 collapsed or were seriously damaged.
- 60% of public buildings, administrative and economic infrastructure, the Parliament and the judicial system, including the Court Building and other courts, were destroyed.
- Approximately 30% of public servants died in the earthquake.
- Property damage: US\$ 4.3 billion.
- Economic losses: US\$ 3.5 billion.

**Total value of damages:**  
**US\$ 7.8 billion (over 120% of the 2009 GDP).**

## International response

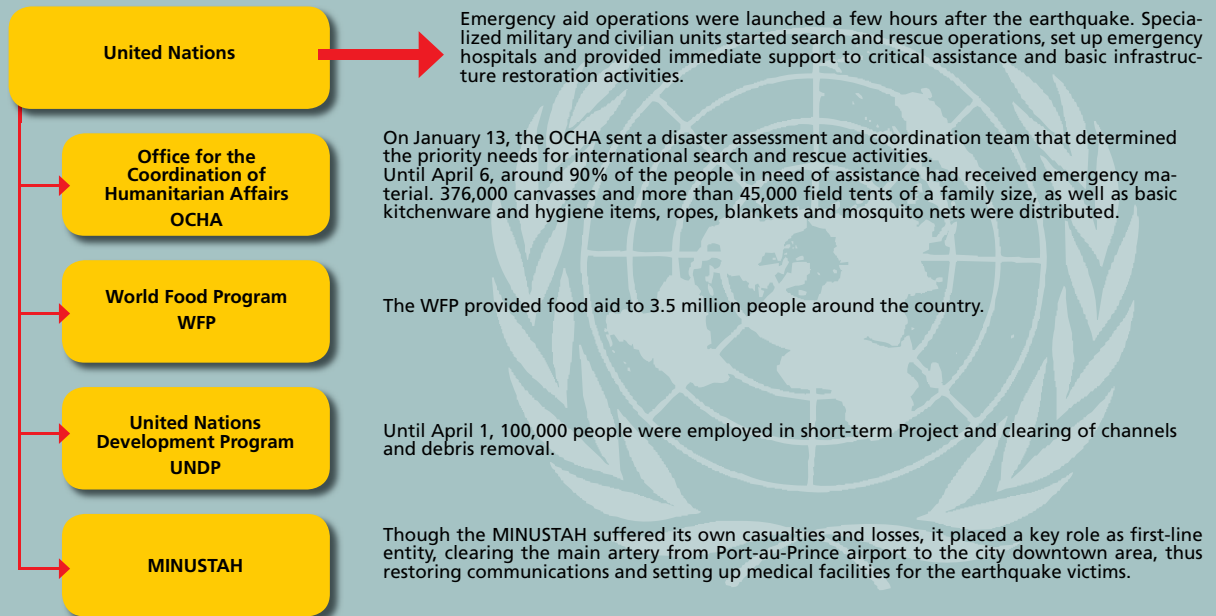

**Source:** Reports of the UN Secretary General on the UN Stabilization Mission in Haiti (MINUSTAH) dated February 22, 2010 and September 1, 2010. Web site of the UN's Special Representative in Haiti.

## OPERATION UNIFIED RESPONSE - Haiti

It was the United States military response to the aftermath of the January 12, 2010 earthquake, requested by the Haitian government. Led by the JTF (Joint Task Force) Haiti and commanded by the USSOUTHCOM (United States Southern Command), it became the largest rapid response operation in a disaster scenario the US DoD has ever deployed to in its history and it made the Southern Command reformulate its organizational command structure.

- Military personnel (maximum number reached): 22,268
- Ships: 23
- Coast Guard cutters: 10
- Aircraft: 264
- Helicopters: 57
- Displaced persons who have been relocated: 3,884
- Rations distributed: 2,900,000
- Supervised flights between Haiti and the Dominican Republic: 3,989
- US citizens moved outside Haiti: 16,412

### Priorities

- Restore the medical capacity.
- Distribute water, food and shelter.
- Integrate with the MINUSTAH and ONGs on the ground.

On June 1, 2010, the SOUTHCOM officially ended the response operation in Haiti.

**Source:** US Southern Command web site. Defence Management, United States Government Accountability Office, July 2007.

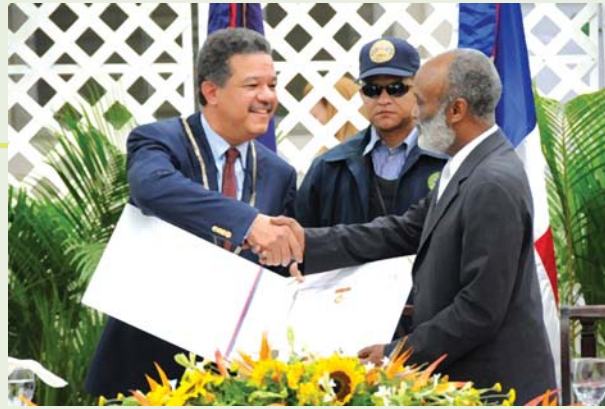

On January 13, the president of the Dominican Republic issued Executive Order N° 24-10 instructing the Ministries of Public Works, Health and Social Security, Armed Forces, Social Plan of the Office of the President, Economical Soup Kitchens, the Office of Public Works Oversight, the National Housing Institute to provide the necessary assistance to aid the neighbouring country of Haiti.

President Leonel Fernández of the Dominican Republic and President René Prével of Haiti, a few moments before the inauguration of the Bilateral Mixed Commission (Comision Mixta Bilateral) on July 30, 2010. The strategic cooperation and integration agenda for sustainable development of national means in matters such as trade, agriculture, tourism, environment, health, education, sports, border issues, immigration, and security. (Photo: President of the Dominican Republic).

### Mano Amiga Plan

The "Friendly Hand Plan" ("*Plan Mano Amiga*"), ordered by the President of the Dominican Republic, involved sending the necessary aid to the Haitian people and offering the right protection to aid organizations and institutions that provide assistance in Haiti.

- The first Dominican contingent that arrived in Haiti included almost 100 people.
- In the city of Jimaní (on the border with Haiti) the command and control post was installed.
- The first phase of the assistance was mainly devoted to search and rescue activities and the provision of pre-hospital medical services. SAR activities lasted 12 days.
- With the support and escort of the MINUSTAH and the local police, members of Civil Defence and the Office of Public Health of the Dominican Republic arrived at Port-au-Prince, which was immersed in chaos. From an assistance camp and Jimaní command post, they provided support for the distribution of humanitarian aid arriving to the site.
- The third phase was to support the deployment of temporary shelters.

The Dominican Republic has been responsible as entrusted by the Haitian government as member of the Interim Haiti Reconstruction Commission.

#### Related organizations

- AECID
- Oxford Committee for Famine Relief (OXFAM – Canada)
- International Red Cross
- MINUSTAH
- International Plan
- UNDP
- UNICEF
- USAID

#### Dominican Republic

- Daily donation of 130,000 food rations and 40,000 raw rations for Haitian victims.
- Construction of 2,600 temporary shelters for refugees.
- Transport of Haitians by Dominican troops.
- Evacuation of earthquake victims.
- Logistic support.
- Air and sea transport of technical civilian and military teams in the areas of communication, rescue and medical personnel.

#### Haiti

**Source:** Compilation based on information supplied by the National Emergency Commission and the web site of the Ministry of Armed Forces of the Dominican Republic.

#### United for a Better Future for Haiti

##### Declaration of Santo Domingo

Upon the initiative of the President of the Dominican Republic, Leonel Fernández, a meeting was held on January 18, 2010 in the city of Santo Domingo, where representatives of the member countries of CARICOM, OAS, Canada, Spain, United States, Brazil, United Nations (MINUSTAH), the European Union and the World Bank discussed the best ways to respond to this dramatic situation and to call for the international community to extend a helping hand to Haiti.

The Declaration established, among other points of agreement, that the Dominican Republic would become the humanitarian corridor for the reception of humanitarian aid; the coordination of assistance would be carried out through the United Nations from the Dominican Republic; a Fund of Donors would be created; and the Haitian foreign debt would be pardoned.

**Source:** Compilation based on the Declaration of Santo Domingo.

#### International Donors' Conference Towards a New Future for Haiti

The purpose of the conference held at the United Nations in New York on March 31, 2010 was to mobilize international support to the development needs of Haiti in an effort to set the foundations for the long-term recovery of Haiti. During the conference, Haiti presented its vision about the country's future and how international support could help in that way. And 151 UN member states were present.

A commitment for 5.6 billion-dollar aid was made for the 2010-2011 period. As of August 2010, 20% of the total amount committed by the countries was effectively granted.

Such financial contributions include the following 9 countries: Australia (US\$9.3 million); Brazil (US\$ 55 million); Colombia (US\$ 4 million); Estonia (US\$ 0.05 million); France (US\$ 6.6 million); Japan (US\$ 56.7 million); Norway (US\$ 33 million); Spain (US\$ 126.3 million) and Venezuela (US\$ 2.1 million).

**Source:** Compilation based on information supplied by the Office of the Special Envoy for Haiti.

#### CARICOM



The Heads of the Governments of the member states of Caribbean Community (CARICOM), following their meeting in Mexico on February 21, 2010, issued a declaration to express their deep solidarity with Haitian people and Government vis-à-vis the death toll and material damages caused by the earthquake of January 12, 2010, acknowledging the urgency to contribute to the international cooperation efforts for Haiti's reconstruction and long-term development

ledging the urgency to contribute to the international cooperation efforts for Haiti's reconstruction and long-term development

**Source:** Mexico Presidency and CARICOM websites.

Región	Personnel contribution (as of April 2010)		Immediate donations (US\$ million as of January 15, 2010)
	Military and police men	Civilians	
United States	22,268	1,100	54.6
Latin America	3,836	798	5.6
Canada	2,046	75	0.6
Caribbean	150	20	1

**Source:** Report Haiti Earthquake prepared by the United Nations Development Programme. Websites of the Ministries of Foreign Affairs, of Defence and the Armed Forces of Latin American countries, the SOUTHCOM and Canada's Department of Foreign Affairs and International Trade.



## Disarmament

The United Nations Disarmament, Demobilization and Reintegration (DDR) Program for Haiti was incorporated to MINUSTAH mandate in 2004. The DDR Section works in close cooperation with National Commission for Disarmament, Decommissioning and Reintegration (NCDDR), created on August 29, 2006.

The purpose of the DDR process is contributing to security and stability in post-conflict situations so that recovery and development can start.

Currently, DDR activities in Haiti are geared to illegal armed rings and groups in the whole country, with particular emphasis on the urban areas of Port-au-Prince.

Purpose:

- Dismantling of armed groups and reinsertion of their members.
- Development of mechanisms for community level talks and conflict management.
- Support to the recovery of the community, creating opportunities for voluntary surrender of arms.
- Enforcing and supporting the application of a legal framework to strengthen control measures against small weapon, ammunition and explosive proliferation.
- Provide communities the means to act together with state actors in the fight against armed violence.

## Process

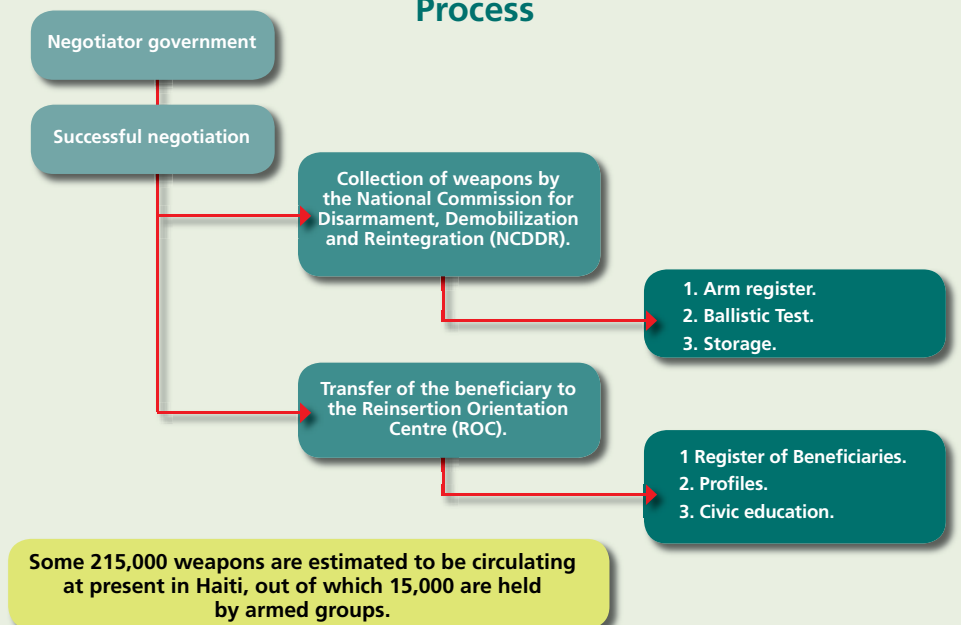

- The negotiation and identification of the beneficiaries is a responsibility of the State - NCDDR.
- All the weapons recovered during the DDR process must be registered in the UN system database.
- There insertion process through ROC lasts 18 months (professional training or business management).
- UNICEF is in charge of children according to the Memorandum of Understanding signed by MINUSTAH and UNICEF on September 12, 2006.

Source: Compilation based on information supplied on the website of Haiti's National Commission for Disarmament, Demobilization and Reintegration.

## Reflections on the Haitian Crisis

Héctor Saint-Pierre

Grupo de Estudios en Defensa y Seguridad (GEDES), UNESP.

The Haitian crisis is an example of the type of post-cold war conflicts that led the United Nations Organization (UN) to implement a sweeping change encompassing from the philosophy to the doctrine of peace mission employment. These are mostly intra-state conflicts characterized by the states inability to guarantee security and by severe humanitarian crises.

The Stabilization Mission in Haiti (MINUSTAH) was original in many ways:

- It was one of the main challenges to Latin America's regional policy, especially in the defence area.
- Their armed forces had never undertaken a joint operation with so many countries.
- For the first time, Latin American forces were employed together with those of other world countries in a peace mission in their own continent under

UN mandate and with Latin American political and military command.

d) It was an unequivocal success for the UN and renewed the morale lost during disastrous experiences in other regions in the world.

e) Latin America was sensitized to detect fledgling conflicts and became aware of its capability and potential to anticipate, contain and solve those conflicts before they spread across borders or need extra-regional solutions.

### Meanings and Lessons

Either for solidarity or for special interests, the perception emerged that the problems affecting one Latin American country can affect a sub-region and impact regional stability. If on the one hand the Haitian crisis generated commotion and a genuine sentiment of solidarity, on the other, the forced migration produced

by it became a direct concern of the countries that were voluntarily or involuntarily receiving Haitian refugees. For one reason or the other, national congresses authorized an unprecedented involvement of their armed forces in the attempt to restore peace, mitigate the pain of the Haitians and stall immigration.

Concurrent with the awareness of regional reciprocal inter-dependence, a transnationalization of problems is perceived. MINUSTAH's initial success encouraged expectations of the potential for sub-regional and regional problems to be contained and resolved at a sub-regional or regional level, with cooperative employment and Latin American resolution proposals and political-strategic command.

Latin Americans developed a strategy with which they succeeded in remarkably reducing the death toll estimated for an operation of such magnitude. Ignoring all appeals for application of a more decided action -and even if the mission had been authorized under Chapter VII- the strategic command of the operation understood that they were in Haiti to bring peace and not to win a war; and that MINUSTAH configuration would allow to bring and maintain peace in the country but would not solve the underlying problem -which depended on international financial support and the reconstruction of the still absent state structure.

Latin American armed forces had an outstanding participation in peace promotion and the assistance for the reconstruction of Haiti, showing capabilities, conditions and coordination to operate autonomously in their region. It was also an excellent training opportunity with other regions' forces in a real-life situation, which allowed troop "socialization" and an updating of war materials and armed forces employment doctrines.

In their ad hoc formulation, the 2 x n mechanism (where 2 is the defence and foreign affairs representation and n the number of participating countries) -which had started as 2 x 4 (Argentina, Brazil, Chile and Uruguay) to later expand to a larger number of countries- appeared as an efficient instrument for political-strategic articulation that could be employed in other circumstances and for other purposes.

It was clear that the rigidity of the mandate may generate instability in missions of this type which, in the MINUSTAH case, may end up compromising

the initial success. The features of UN peace missions cover the whole range from "peace imposition" to "peace reconstruction" (or, the latter would be better expressed as "the reconstruction of the State to maintain it"). Their goal is the transformation of war situations or humanitarian crises, for which to attain their goal, they should transform themselves to remain adapted to a changing situation. To the extent that peace was attained in Haiti, adapting to new circumstances demanded a steady replacement of the military by police forces and other agents contributing to the reconstruction of the country's administration and production structures. However, given the difficulties for transforming the mission and obtaining approval by the Security Council, bureaucracy prefers the less controversial measure for the renewal of the mandate.

The earthquake that hit Haiti was an unexpected additional challenge to MINUSTAH, which needed to alter its mission to recover from the disaster and adapt itself to be able to meet the increasing demands of a bereft population. A critical moment was the deployment of North American troops not subordinated to MINUSTAH command. However, the urgency of the assistance to the victims and the cooperation agreements allowed overcoming that situation and successfully completing the mission.

Regarding the armed forces' mission, the disaster left as a lesson the importance of having an updated doctrine and specific preparation for disaster response. Their logistics capabilities, immediate mobilization and fast deployment turn the armed forces into a very important instrument for calamity contingencies. On the other hand, the intrinsically transitory nature of these phenomena prevents these missions from becoming permanent. The prevention to effectively respond to these emergencies recommends a cooperative and joint preparation of the troops from the different countries in each sub-region. This aspect is being closely observed in South American Defence Council's forums, since the preparation and joint exchange of the armed forces of participating countries, aside from a preventive measure highly advisable vis-a-vis the unpredictability of disasters, constitutes an effective sub-regional confidence building measure.



